

Historic, Archive Document

Do not assume content reflects current scientific knowledge, policies, or practices.



2,33

seeds
bulbs
plants

LIBRARY
RECEIVED
FEB 3 1941
U. S. Department of Agriculture.

Agricultural Implements



the
Seedsman

1941

16 SOUTH MARKET ST.
BOSTON MASS.

Novelties and Specialties in Flower Seeds for 1941

Ageratum

- 148 **MIDGET BLUE**. A very fine dwarf plant 2 to 3 inches high with delicate fine foliage smothered with small true Ageratum-blue flowers. Pkt. 25c.

Amberboa

- 225 **MURICATA**. This desirable annual has lace-edged, starry flowers of Tyrian purple, and is variously called Star of Spain, Star of Africa or Star of Egypt. The plant grows 30 inches tall and has good foliage; the blooms cut well and the plant stays in bloom for many months. Pkt. 25c.

Aquilegia (Columbine)

- 465B **LONGISSIMA HYBRIDS**. These new hybrids contain all the beautiful hues of the Mrs. Scott-Elliott Strain, red, blue, white, etc., in conjunction with the length of spurs of the longissima type, often 4 inches. Invaluable both for border and as a cut flower. Pkt. 50c.

Begonia

- 1165 **INDIAN MAID, GRACILIS**. Foliage deep lustrous bronze with rich scarlet flowers. Dwarf compact habit. Pkt. 75c.
- 1205 **FELTHAM BEAUTY**. A semperflorens type with fine large flowers of light salmon-pink, foliage green. Pkt. 50c.
- 1209 **SNOW**. Semperflorens Heterosis. This profuse flowering hybrid is outstanding on account of its resistance to heat, drought and excessive moisture. Pure white medium sized flowers, rosy stems and light green leaves. Plant about 10 inches high. Pkt. \$1.00.
- 1176 **WINTER ROMANCE**. Rich carmine-scarlet. Pkt. 75c.
- 1177 **WINTER ROMANCE WHITE**. Seed sown in July flowers at Christmas. Pkt. 75c.
- 1178 **"TAUSENDSCHOEN" GRACILIS COMPACTA**. 5 inches high. Plant of regular compact growth. Flowers rich rose in a profusion of bloom. Good for bedding or conservatory. Pkt. 75c.
- 1212 **ROSE PEARL SEMPERFLORENS**. Plants 8-9 inches high, flowers often 2 inches across of soft pink shade with foliage of glossy mid-green. Pkt. 50c.

Front Line News!!

We think it best to remind you that the war situation abroad and our own government activities at home are greatly affecting not only the bulb and seed situation, but the manufacture of our merchandising items at this time.

Prices cannot be guaranteed and deliveries are problematical. Please assist us in our efforts to continue our usual policy of superior service on your requirements by placing your orders in advance of your actual needs, allowing us as much time as is possible for shipment.

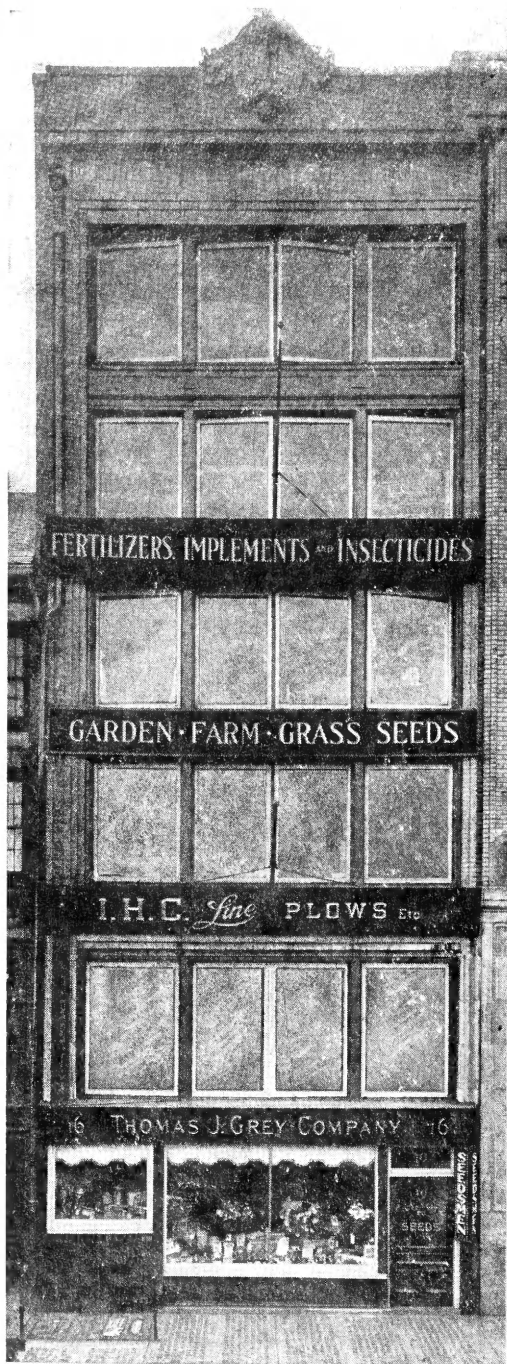

Established 1888

THOMAS J. GREY COMPANY

"The Seedsmen"

16 SOUTH MARKET ST.

BOSTON, MASS.

Telephones: CAPitol 7476 - 7477

GREY'S NOVELTIES and SPECIALTIES FOR 1941

Flower Seeds

ASTER

NEW WILT RESISTANT PRINCESS TYPE

This new type has blooms with a full crested center surrounded by several rows of strong guard petals. Plants are from 18 to 24 inches in height, with strong stems of good length. Flowers are from 3 to 3½ inches, come into bloom in mid-August and are fine keepers and good shippers.

- 780 **PRINCESS ANN.** Peach blossom. Opening delicate pink and turning rose-pink. ¼ oz. 85c; pkt. 25c.
 782 **PRINCESS BONNIE.** Soft salmon-rose. ¼ oz. 85c; pkt. 25c.
 784 **PRINCESS MARSHA.** Strong, vibrant cinnabar-scarlet. ¼ oz. 85c; pkt. 25c.

GIANT HARMONY TYPE ASTER

The Harmony type is an excellent non-resistant cutting strain. The large flowers have full double quilled rounded centers, surrounded by several rows of broad, short guard petals. Blooms 4 to 4½ in. on plants 2 to 2½ ft. tall with long basal branching stems.

- 812 **MOONLIGHT.** Beautiful soft azure-blue. Gold center. ¼ oz. 85c; pkt. 25c.
 814 **MORNING MIST.** Deeper than Moonlight, a sultry mid-blue shade. ¼ oz. 85c; pkt. 25c.



Aster, Princess Bonnie

- 816 **SUNRISE.** Exquisite delicate apricot-pink. ¼ oz. 85c; pkt. 25c.
 818 **HARMONY MIXTURE.** ¼ oz. 85c; pkt. 25c.



Antirrhinum, Amber and Gold

NEW ANTIRRHINUMS

SEMI-DWARF RUST-RESISTANT STRAIN

- 336 **AMBER AND GOLD.** Hoods of golden amber, tube of soft rose-pink and golden yellow lips. Pkt. 25c.
 338 **APPLE BLOSSOM.** The first pink in this nanum-grandiflorum class. The blooms are rosy pink with white tubes. Pkt. 25c.
 342 **DUBARRY.** This flaming salmon-rose Antirrhinum has gold shadings that heighten its intensity and make a gorgeous display when planted en masse in a bed. Pkt. 25c.

CAMPANULA PERSICIFOLIA

- 1419 **WEDGWOOD BLUE.** Beautiful new shade of rich, deep violet-blue. Effective as a cut bloom for indoors, and as a useful addition to the herbaceous border. Pkt. 35c.

LOBELIA

- 5278 **PRIMA DONNA.** A new trailing variety with flowers of a beautiful wine color. Pkt. 25c.

Flower Seed Novelties and Specialties—Continued

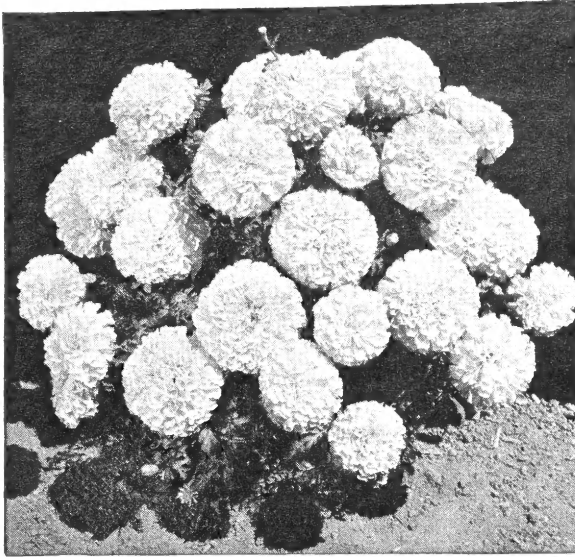

Marigold, Pot o' Gold

MARIGOLD NOVELTIES

- 5453A **MISSION GIANTS MIXED.** These giant incurved Chrysanthemum shaped blooms make huge balls 4 to 5 inches across, on 18-inch base branching plants, whose laterals produce as large blooms as the center stem. Well blended, early flowering mixture. Pkt. 25c.
- 5453B **MISSION GIANTS GOLDSMITH.** An All-America Selection in the Mission Giant type, having flowers of a rich golden orange. Pkt. 25c.
- 5472 **CARNATION FLOWERED ORANGE SUPREME.** Popular carnation flowered type with loosely ruffled, broad petaled flowers of deep orange. 2 to 2½ ft. Pkt. 20c.
- 5440 **COLLARETTE YELLOW CROWN.** Bright canary-yellow flowers with crested centers and broad guard petals. 2 ft. Odorless. Pkt. 20c.
- 5492A **DWARF FRENCH QUILLED SUNBEAM.** Flowers are golden orange, in the new quilled or scabious-flowered class, with center petals tightly quilled and guard petals showing small brown flakes at their base. The plants grow about 15 inches high and are 20 inches across with 1½ inch flowers, early blooming and prolific. Pkt. 25c.
- 5466 **DWARF GIGANTEA POT O' GOLD.** The beautiful golden flowers are somewhat loosely formed, very full centered, with broad overlapping petals. The dwarf compact growing plants, 12 to 15 in. tall, are well branched, neat in appearance and exceptionally early flowering. Pkt. 25c.
- 5497 **SPRY.** This little 9-inch Marigold makes a showy edging plant with its light orange crested center and maroon outer petals. It is profuse blooming and very early. Pkt. 25c.
- 5491A **GYPSY JEWELS.** A colorful, very showy Marigold; a jewel-like adornment for any garden. The dwarf, compact, neatly formed plants 12 to 15 inches tall, are early and very free blooming with fully 95% double flowers of a wide range of brilliant colors. Pkt. 25c.
- 5511A **TALL FRENCH SINGLE FERDINAND.** The flowers have a round crested center of golden yellow florets with a single row of broad guard petals. Plants are about 2 ft. tall, early blooming and without the strong Marigold odor. Pkt. 25c.
- 5496A **SCARLET GLOW.** Dwarf French double of a distinct bright bronzy red color, nearly 2 inches across. Plants 12 inches tall. Pkt. 25c.

PETUNIA

- 6297A **PETUNIA BALCONY MACULATA.** The large, semi-ruffled flowers are delicately toned from a pure white base to spots of deep rose-red on the outer fringe of each flower. The open throat is golden yellow with exquisite vein markings spreading outward and suffusing the brilliant rose-red stripes. Pkt. 25c.
- 6363 **PETUNIA SUPER FLUFFY RUFFLES SALMON ROSE.** Blooms 3½ to 4 inches across of beautiful deep salmon-rose with a golden throat. The flowers are so frilled and ruffled they resemble doubles. Pkt. \$1.00.
- 6366 **PETUNIA SUPER FLUFFY RUFFLES MIXED.** The flowers are very large, having the outstanding beauty of the loveliest frills and ruffles imaginable. The mixture is well balanced of pink and white, salmon and rose shades, crimson and light blue. Pkt. \$1.00.

PETUNIA ALL DOUBLE VICTORIOUS

- 6368F **DWARF FRINGED BLUE BROCADE.** This new variety is a true violet-purple without the reddish cast often seen in purple varieties. Pkt. \$1.00.
- See page 29 for full list of all Double Victorious varieties.

- 6302 **PETUNIA HYBRIDA FIRST LADY.** A fine free blooming dwarf Petunia in a new soft light pink. A good contrasting color companion to the variety Glow. (See page 28). Pkt. 35c.

- 6318 **PETUNIA HYBRIDA RADIANCE.** This new Petunia has blooms of rich brilliant cerise-rose with enough underlying salmon to remove the harshness sometimes seen in cerise-rose, and with a throat of golden yellow. The blooms are 2½ to 3 inches across on very free flowering plants of neat, uniform habit. Pkt. 25c.

NOVELTY NASTURTIUMS

See page 26

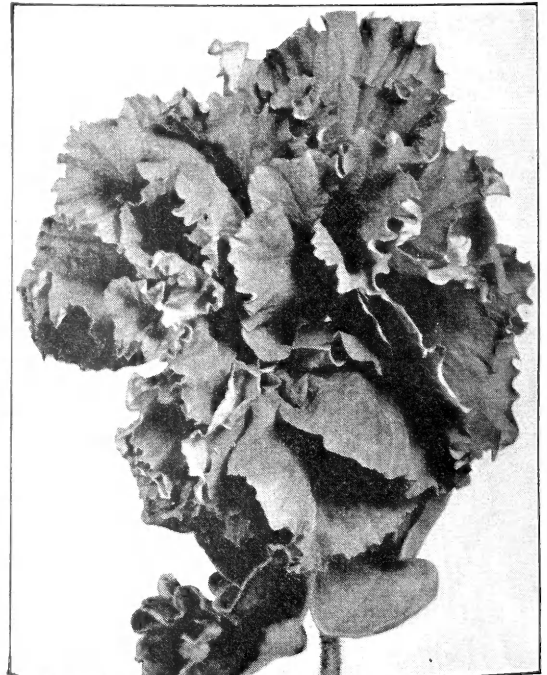

Petunia, Blue Brocade

PHLOX

6428A **PHLOX DRUMMONDI GIGANTEA ROSY MORN.** This extra large annual Phlox is a pleasing brilliant rose with a white eye. It is early, free blooming, true and uniform. 1 ft. tall. Pkt. 25c

ICELAND POPPY

6620 **POPPY ICELAND PASTEL TINTS.** This new strain of large flowered, daintily ruffled Iceland Poppies has a harmonious blend of the following soft shades: salmon-pink, lemon, orange, golden shades, biscuit, white and pink. Picked in the bud and placed in water over night, they make dainty flowers for table decoration. Pkt. 25c.

PRIMULA

PRIMULA, GIANT MALACOIDES. The strong robust growing plants make excellent pot plants, with extremely large, well-formed, rounded flowers produced in abundance on heavy wiry stems rising from rich green foliage. Well grown plants will have from 30 to 50 spikes of lovely blooms.

- 6965 **DOUBLE FAIRY JEWELS.** Rich rose-pink. Pkt. \$1.50.
- 6966 **ENCHANTRESS.** Soft salmon-rose. Pkt. \$1.50.
- 6967 **LAVENDER GLORY.** Beautiful mauve-lavender. Pkt. \$1.00.
- 6968 **SNOW FLAKE.** Pure glistening white. Pkt. \$1.00
- 6969 **MIXTURE.** Pkt. \$1.00.

SCABIOSA

7176 **PEACE.** A semi-tall, double white companion to Heavenly Blue. Flowers beehive shape on 6 to 8 inch good cutting stems. Pkt. 25c.

STOCK

DOUBLE GIANT EXCELSIOR, COLUMN
 7398 **YELLOW WONDER.** This new stock is rich creamy yellow with full double florets, 2-2½ inches across on 3 ft. spikes, having 15-18 inches of blooms when grown under ordinary field conditions. In the greenhouse this stock will produce spikes of about 26 inches. 1/16 oz. \$1.50; pkt. 35c.



Zinnia, Howard's New Giant Crested Mixed

SWEET PEAS

NEW SPRING FLOWERING SPENCERS

Intermediate in season between Early and Standard Spencers, possessing the characteristic of heat resistance; maintains remarkable vigor, length of stems, size of flower and productivity throughout the growing season, both under glass and outdoors. Midwinter sowing in the greenhouse gives flowers for early April picking.

NEW VARIETIES FOR 1941

- SPRING FLOWERING WHITE.** (Black Seeded). Vigorous and very long stemmed. Pkt. 25c.
- SPRING FLOWERING CLEAR PINK.** A soft shade with little salmon tone. Pkt. 25c.
- SPRING FLOWERING MAUVE.** Rich and glistening. Pkt. 25c.
- SPRING FLOWERING BLUE.** Oz., \$2.00; Pkt. 25c.
- SPRING FLOWERING LAVENDER.** Oz. \$2.00; pkt. 25c.
- SPRING FLOWERING ROSE.** Oz. \$2.00; pkt. 25c.

ZINNIA

8507 **ZINNIA BLACK RUBY.** This deep velvety maroon Lilliput Zinnia is most effective used with lighter colors; 18 inches tall. One of the All-America prize winners. Pkt. 25c.

8372 **HOWARD'S NEW GIANT CRESTED.** This new strain is a cross of the dahlia flowered and scabiosa flowered types. Blossoms are 4 to 5 inches across, with a full rounded cushiony center surrounded by broad guard petals. Magnificent shades of orange, scarlet, yellow, rose, maize and crimson predominate. Mixed colors. ¼ oz. \$1.00; pkt. 25c.



Phlox, Rosy Morn

Seeds of Hardy Rock Garden Plants



Aubrieta Eyri

- 102 **AETHIONEMA** (Persian Candytuft). 9 in. June-July. Sun. Strong, twiggy bushes with long, slender spikes of rosy pink flowers. Pkt. 30c.
- 202 **ALYSSUM serpyllifolium (Alpestre)**. Very dwarf. 4-5 in. Racemes of pale yellow flowers and rough, hoary leaves. Blooms just after the well known Saxatile variety. Pkt. 20c.
- 252 **ANEMONE pulsatilla** (Pasque Flower). 10 in. April-May. An interesting plant producing violet or purple flowers. Pkt. 25c.
- 432 **AQUILEGIA alpina**. Dwarf, dark blue. Pkt. 25c.
- 519 **ARENARIA (Sandwort)**, *montana*. 6-8 in. Grows in close tufts of bright green foliage, profusely covered in the spring with small silvery white flowers. Pkt. 25c.
- 528 **ARMERIA Lancheana**. Dwarf Thrift. Rose. Six inches. Pkt. 25c.
- 1068 **AUBRIETIA Eyri**. A dainty low creeping plant. Fine for crevices of rocks. Rosy lilac, flowers for a long period. Pkt. 30c.
- 1292 **CALANDRINIA umbellata**. 4-5 in. Will do well in a hot location where other plants may not succeed. Bright crimson saucer-shaped flowers. Prostrate habit. Pkt. 20c.
- 1392 **CAMPANULA garganica**. June. A low spreading tuft with starry light blue flowers, small white eye. Fine for hanging over a rock. Pkt. 35c.
- 1403 **CAMPANULA Raineri**. Erect blue flowers in June, July. Plant dwarf, spreading. Pkt. 25c.
- 1435 **CAMPANULA rotundifolia** (Scotch Bluebells). 1 ft., June to August. Clear blue flowers, especially adapted for crevices. Also does well on steep slopes. Pkt. 25c.
- 2498 **DIANTHUS caesius grandiflorus** (Cheddar Pinks). Rosy pink, 6 inches. Pkt. 15c.
- 2510 **DIANTHUS Allwoodi alpinus**. 6 in. June-July. Glossy foliage with large bright rose flowers. Thrives best in loams to which a little lime has been added. Shade a little in hottest part of summer. Pkt. 50c.
- 2658 **ERINUS alpinus roseus**. 4 in. May-June. The foliage grows in rosettes, the flowers in racemes of rosy purple. Fine for pockets or between steps. Pkt. 25c.
- 3026 **GYPHOPHILA repens**. Trailing rose-pink Baby's Breath. $\frac{1}{4}$ oz. 40c, pkt. 15c.
- 5228 **LAVANDULA, Munstead Strain**. 1 ft. Dwarf, compact, early flowering type with deep lavender flowers. Pkt. 25c.
- 5247 **LINUM, alpinum**. Beautiful true blue flax of spreading habit, blooming in May and June. Best rock garden variety. Pkt. 25c.
- 5248 **LINUM flavum nanum compactum**. Glowing yellow new dwarf Flax suitable for borders and rockeries. Pkt. 25c.
- 5388 **LYCHNIS alpina**. 1 ft. A pretty dwarf plant with clusters of brilliant rose colored flowers in spring and early summer. Pkt. 25c.
- 6012 **NEPETA Mussini** (Ground Ivy). 1-1 $\frac{1}{2}$ ft. Fine in the rock garden; compact habit, producing masses of lavender flowers. Pkt. 25c.
- 6014 **NEPETA nervosa** (Catmint). 1 ft. Bright, clear blue. Pkt. 25c.
- 7152 **SAXIFRAGA umbrosa** (London Pride). Sun or shade. Numerous small pink flowers, fine for rocks or edging; foliage a solid carpet. Pkt. 30c.
- 7262 **SILENE Schafta** (Autumn Catchfly). 4 to 6 in. July to October. When in flower they are a mass of bright pink. Pkt. 20c.

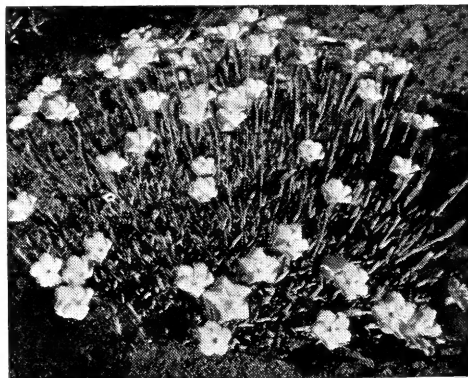

Dianthus Grandiflorus

- 8162 **TUNICA saxifraga** (Coatflower). 6 in. Beautiful tufted plant with light pink flowers all summer. Fine for border or rockery. Pkt. 20c.
- 8223 **VERONICA incana (candida)**. 1 ft. July-August. A white, woolly plant with numerous blue flowers. Makes a fine show even when not in bloom. Pkt. 25c.

Other Seeds of Rock Garden Plants to be Found in Catalog

Hardy Varieties: Alyssum saxatile compactum, Achillea, Arabis, Armeria, Asperula, Aubrieta, Campanula carpatica, Cerastium, Cheiranthus, Dianthus deltoides, Edelweiss, Geum, Helianthemum mutabile, Heuchera, Iberis (Perennial Candytuft), Linum, Primula (hardy varieties), Sedum.

Annual Varieties: Alyssum, Dwarf; Antirrhinum, Tom Thumb varieties; Candytuft, dwarf varieties; Marigold, dwarf varieties; Mesembryanthemum; Petunia, dwarf varieties; Portulaca; Silene; Viola cornuta; Zinnia, Lilliput and Gem varieties

Grey's Superior Flower Seeds

A very carefully revised list to which many meritorious and recently introduced sorts have been added and all inferior varieties discarded.

All flower seeds mailed free on receipt of price quoted.

If the number is used when ordering, it will not be necessary to write the name.

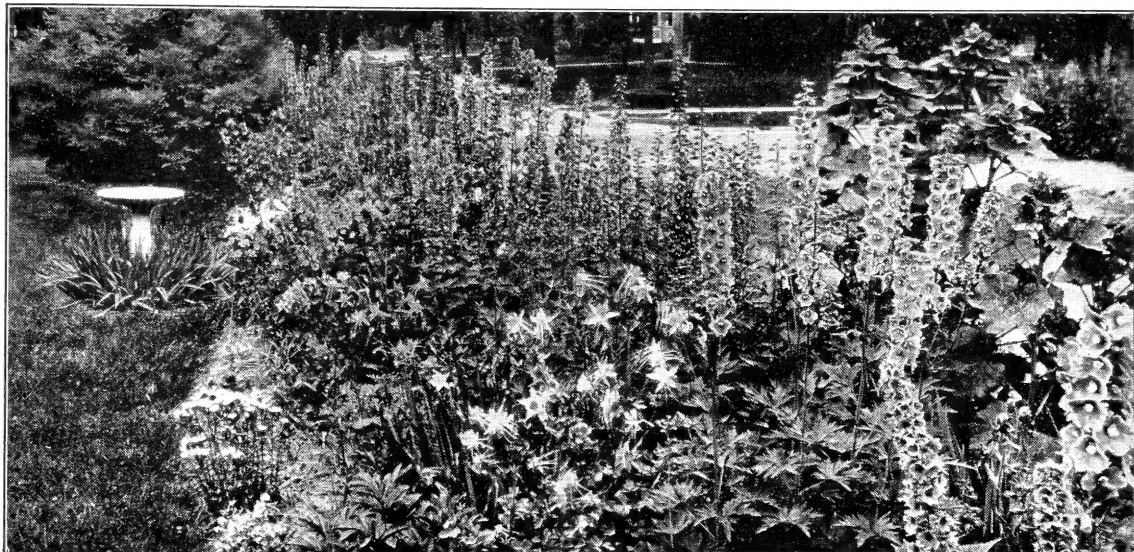

No.		Pkt.	No.		Pkt.
10	ABUTILON, Prize Mixed (Flowering Maple). Perpetual bloomers and rapid growers; seed sown indoors in March will produce plants that will bloom outdoors during the summer and indoors all winter....	\$0.25	84	Sensation Giants. The large 3-inch, fully double flowers range from medium rose to light pink shades, on plants 6 to 8 inches taller than other strains. It is hardy and early blooming, resembling a Comet type aster plant. Flowers picked in the bud and hung out to dry will be a source of enjoyment for the winter months	\$0.20
15	ACACIA baileyana. Long sprays of bright yellow flowers; excellent for cutting. ¼ oz.	.50c .25		ADONIS. Free-flowering border plants, with showy flowers of easy culture.	
25	lophantha speciosa. Fine yellow, delicate foliage	¼ oz. 35c .15	95	aestivalis (Flos Adonis). Deep crimson, free flowering annual. 1 ft.	¼ oz. 25c .10
	ACANTHUS. Stately ornamental, hardy perennials, remarkable for their beautiful foliage, and curious flowers in Aug. and Sept. 2 to 4 ft.		100	vernalis. Large, yellow flowers in May and June. Hardy perennial. 1 ft. ¼ oz.	\$1.00 .10
40	mollis latifolius. Handsome sort. ¼ oz.	35c .15	105	AGATHEA coelestis (Blue Marguerite). Free blooming, tender perennial with blue daisy-like flowers. Fine for winter flowering and a good bedder. 1½ ft.25
45	ACHILLEA, The Pearl. One of the best hardy perennials, covered with heads of pure white, double flowers from spring till frost; fine for cutting; 1½ ft.25		AGERATUM. Effective plants for bedding, covered with bloom throughout the season.	
50	ACHIMENES, Superb Mixed. Profuse blooming greenhouse plants, 1 ft. high, flowering through the summer50	106	Blue Ball. 4 in., deep blue.....	.25
	ACONITUM (Monkshood). Hardy perennials, with long spikes of hood-shaped flowers, excellent for shrubby borders and shady places. June to Sept.		108	Blue Cap. Large, deep blue flowers, small foliage; 5 in.25
55	napellus. Large deep blue. 3 ft. ¼ oz.	\$1.25 .15	110	Blue Perfection, Deep blue.....	¼ oz. 60c .15
60	napellus roseum. Pink25	115	Blue Star. Bright blue; 5 in.	½ oz. 75c .25
68	wilsoni. Large trusses, light blue. 4 ft....	.25	118	Fairy Pink. 5 in. Salmon-rose25
70	Finest Mixed	¼ oz. 60c .10	120	Imperial Dwarf. Dark blue; 8 in. ¼ oz.	75c .15
	ACROCLINIUM. One of the prettiest and best annual everlasting for cutting fresh or for winter use.		125	Imperial Dwarf. White; 8 in.....	¼ oz. 85c .15
75	Double Rose	¼ oz. 35c .10	130	King of the Blues. Small tufty compact plants with flowers of deepest blue showing effectively above the foliage....	.25
80	Double White	¼ oz. 35c .10	135	Little Dorrit, Azure blue; 8 in... ¼ oz.	50c .10
			140	mexicanum. Lilac-blue; 1½ ft. ¼ oz.	50c .15
			145	mexicanum album grandiflorum. ¼ oz.	50c .15

No.		Pkt.
155	AGROSTEMMA coronaria (Mullein Pink). Free flowering, hardy perennial, bright crimson flowers; fine for cutting; 2 ft. ¼ oz., 25c	\$0.10
160	hybrida walkeri . Bright rose; hardy.....	.15
165	coelirosa (Rose of Heaven). Fine annual sort, with rose flowers. Fine for cutting; 1½ ft.....	¼ oz. 25c .10
170	ALONSOA, Mutisi . Delicate pink, dark center (Maskflower). Charming annual, flowering throughout the summer and autumn, 1½ ft.	½ oz. 30c .15
	ALYSSUM . Dwarf-growing annuals, blooming profusely throughout the season.	
180	benthami (Sweet Alyssum). White, fragrant, free bloomer; 1 ft.	4 ozs. \$1.50, oz. 50c .10
185	Carpet of Snow (White Fleece). Pure white, very dwarf and sweet; 4 in.....	¼ oz. 40c, oz. \$1.25 .15
187	Lilac Queen . Dwarf annual....	¼ oz. 50c .10
190	Little Dorrit . A perfect gem for borders or beds, compact, white and sweet. ¼ oz. 40c	.15
195	Little Gem . White, distinct and very sweet, ½ ft.	¼ oz. 30c, oz. \$1.00 .10
196	Lutescens . 6 in. Annual; creamy yellow..	¼ oz. 40c .15
198	Minimum . 3 in. Very dwarf compact white	¼ oz. 40c .15
199	Violet Queen . A dwarf compact form with honey-like fragrance and flowers of bright violet tint25
200	saxatile compactum (Gold Dust). Bright, yellow, spring flowering, hardy perennial; 9 in.	¼ oz. 85c, oz. \$3.00 .15
201	saxatile, Silver Queen . Pale yellow ...	¼ oz. 75c .15
	AMARANTHUS . Brilliant foliated annuals, with showy racemes of flowers; very ornamental and excellent for borders and sub-tropical gardening.	
205	caudatus (Love-lies-bleeding). Long drooping, scarlet racemes; 3 ft.	¼ oz. 25c .10
212	Molten Fire . Brilliant poinsettia-like tips.	.15
220	tricolor splendens (Joseph's-coat). Foliage crimson, yellow and bronze; 2 ft.	¼ oz. 50c .15
230	AMBROSIA mexicana . Sweet-scented annual. Useful in bouquets; 1 to 1½ ft.	¼ oz. 40c .10
238	ANCHUSA, Blue Bird . Annual. Indigo blue..	.30
240	capensis . Annual. Fine azure blue Forget-me-not-like flowers. 1 ft.	½ oz. 35c .10
242	barleriiflora . Perennial. Dwarf, blue.....	.25
245	italica, Dropmore Variety . Perennial. Gentian-blue; 4 ft.	¼ oz. 85c .25
246	Lissadell . Perennial. Bright gentian-blue; 5 ft.35
248	Myosotidiflora . Perennial, 1 ft. May. A Russian variety with clusters of blue flowers resembling Forget-me-nots.....	.25
250	ANEMONE coronaria, St. Brigid . An improved strain of the hardy garden Anemone, with larger and more brilliant flowers; 1 ft.20
251	De Caen (French Anemone). Mixed15
251A	His Excellency . Single fiery scarlet20
255	ANTHEMIS kelwayi (Hardy Marguerite). A most satisfactory hardy perennial, bearing throughout the summer, golden yellow daisy-like flowers, excellent for cutting. 2 ft.	¼ oz. 50c .10

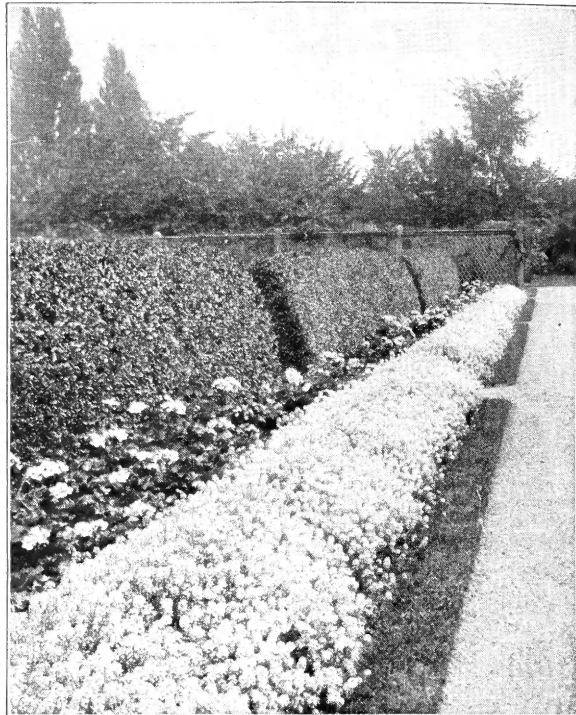

Alyssum, Carpet of Snow

ANTIRRHINUM (Snapdragon).**MAXIMUM TYPE**. 2¼ ft. Rust-resistant.

No.		Pkt.
260	Alaska . Glistening white	\$0.25
260A	Campfire . Scarlet25
261	Canary Bird . Soft yellow25
262	Copper Queen . (New.) Bright bronzy copper25
263	Paradise Rose . Rose-pink25
265	Red Cross . Deep crimson25
266	Salmon-Rose Shades25
267	Swing Time . Rose-pink, white tube25
267A	Yellow Giant . Deepest yellow25
268	Mixed25
269	Collection of 7 varieties	1.50
	TALL GIANT RUST-RESISTANT . 2½ ft.	
270	Brilliant Rose . Bright clear rose-pink25
272	Buttercup . Yellow20
274	Daintiness . Rose-pink20
276	Harmony Shades . Terra cotta and rose20
278	Opal Shades . Shades of pink with apricot25
282	Padre . Glistening crimson25
283	Rosalie . Rich, deep rose with underlying tone of topaz25
284	Salmon-Rose Shades25
286	Shasta . Pure white20
288	Stoplight . Vivid signal-red25
290	Torchlight . Garnet suffused orange20
292	Yellow Jacket . Clear very deep yellow25
294	Mixed20
296	Collection of 10 varieties	2.00
	SUPER MAJESTIC RUST-RESISTANT	
300	Autumn Glow Shades . Rose with amber ..	.35
305	Dainty . Soft pink35
310	Orange Shades35
315	Red Rocket . Bright scarlet to crimson ..	.35
320	Rose Sensation . Rich rose-pink, solid color.	.35
325	Royal Crimson . Velvety garnet-crimson ..	.35
328	Silver-Pink . White blotch on lip35
330	Mixed35
335	Collection of 7 varieties	2.00

No.		Pkt.
ANTIRRHINUM—Continued		
SEMI-DWARF RUST-RESISTANT. 15 to 18 inches.		
340	Carmine-Rose	\$0.15
345	Glowing Sunset. Rosy scarlet15
348	Guinea Gold. The color is a blending of orange-gold and terra cotta25
350	Indian Girl. Old gold15
360	Red Boy. Rich deep scarlet15
370	Wildfire. Bright orange-scarlet15
380	Mixed15
385	Collection of 6 varieties75

TOM THUMB VARIETIES, 8 to 10 in.

Excellent for bedding, blooming all Summer.

395	Brilliant Crimson	1/8 oz. 85c .15
400	Bronze and Gold	1/8 oz. 85c .15
405	Canary Yellow	1/8 oz. 85c .15
410	Dark Scarlet	1/8 oz. 85c .15
412	Pinkie. Bright rosy pink.....	1/8 oz. 85c .15
415	Snowflake. Extra pure white.....	1/8 oz. 85c .15
420	Choice Mixed	1/8 oz. 85c .15
425	Collection of 8 Varieties75

ANTIRRHINUM FOR GREENHOUSE

	Afterglow. Bronze	1.00
	Bertha Baur. Lavender	1.00
	Ceylon Court. Improved yellow	1.00
	Cheviot Maid Supreme. Dark rose-pink ..	1.00
	Cincinnati. Light rose-pink	1.00
	Lucky Strike. New white	1.00
	New Dawn. Golden bronze	1.00
	Orchid (Schrock's)	1.50
	Radiance. Clear pink	1.00
	Rose Queen	1.00
	Sunshine. Deep yellow	1.00
	Terry's Surprise Imp. Bronzy pink	1.00
	Velvet Beauty. American-Beauty-red	1.00
	Weld Pink	1.00
	White Prosperity	1.00
	White Wonder	1.50
	Winter Helen. Salmon	1.00

AQUILEGIA (Columbine). Beautiful, free-flowering, hardy perennials, blooming profusely through the spring and early summer; of easiest cultivation. 1½ to 3 ft.

430	Grey's Columbia Hybrids. Special long-spurred strain. The colors include the most charming combinations from the brightest to the most delicate tints....	
		1/8 oz. \$1.50, 1/4 oz. \$2.50 .50
434	Blue Shades. Long-spurred25
435	canadensis. Scarlet and yellow..	1/8 oz. 75c .15
440	chrysantha. Bright yellow	1/8 oz. 75c .15
448	clematiflora. Spurless. Delicate pastel shades35
450	coerulea (Rocky Mountain Columbine). Splendid, large, light blue ...	1/8 oz. \$1.00 .25
460	coerulea, Rose Queen. Long spurs25
461	Crimson Star. Crimson with white corolla.25
462	Dobbie's Imperial Hybrids.	1/8 oz. \$1.50 .50
465	glandulosa. Deep blue, with white center..	.25
465A	longissima. Pale yellow, very long spurs, 4 in.50
466	Long-spurred Pink Shades.	1/8 oz. \$1.50 .25
467	Mrs. Scott Elliott's Strain	1/8 oz. \$1.50 .50
478	Orange and Scarlet Shades, Long Spurred. ..	.25
482	Snow Queen, Long Spurred.	1/8 oz. \$1.50 .25
485	Mixed Single Varieties	1/4 oz. \$1.00 .10
490	Mixed Double Varieties	1/4 oz. \$1.50 .25

500	ARABIS alpina. Hardy perennial, with pure white flowers blooming early. 1/4 oz. 50c	.10
505	grandiflora superba. Large flowers. 1 ft. .	.15

No.		Pkt.
515	ARCTOTIS grandis. Handsome annual with large, daisy-like flowers, white, with light blue center. 2 ft.	1/4 oz. 75c \$0.15
518	Autumn Shades. Mixed colors; 2 ft. Various tones of red, orange, and bronze, reminiscent of Indian Summer.....	.25
520	ARGEMONE grandiflora. Annual. Large pure white poppy-like flowers; golden yellow center. 2 ft.	1/4 oz. 50c .10
	AERERIA (Thrift, or Sea Pink). Pretty, hardy perennial for edgings, blooming all summer; tufted flowers.	
525	formosa. Deep rose. 1 ft.	1/4 oz. 60c .10
535	ASCLEPIAS tuberosa. One of the most showy of our summer and autumn flowering, hardy perennials, the umbels of bright, orange-colored flowers. 1½ ft....	1/4 oz. \$2.00 .25
540	ASPARAGUS plumosus nanus. Beautiful house plants; the feathery foliage is unrivaled for cutting.....	100 seeds, \$1.25 .25
545	sprengeri. Excellent plant for table decorations or to grow in pots or baskets... ..	1/4 oz. 35c .25
550	ASPERULA azurea setosa. Annual species of Woodruff, with fragrant, light blue flowers, blooming through the Summer and fine for cutting. It will grow in poor soil or in shaded places. 1 ft. 1/4 oz. 50c	.15
555	odorata (Sweet Woodruff). Hardy perennial, conspicuous in May by its pure white, sweet-scented flowers. The foliage and flowers when dried retain their fragrance. Grows well under trees....	1/4 oz. 85c .15
	ASPHODELUS. Showy plants with handsome flower spikes. They grow well in any soil. Hardy perennial.	
570	luteus. Fine, yellow, fragrant. 3 ft.	1/4 oz. \$1.00 .15

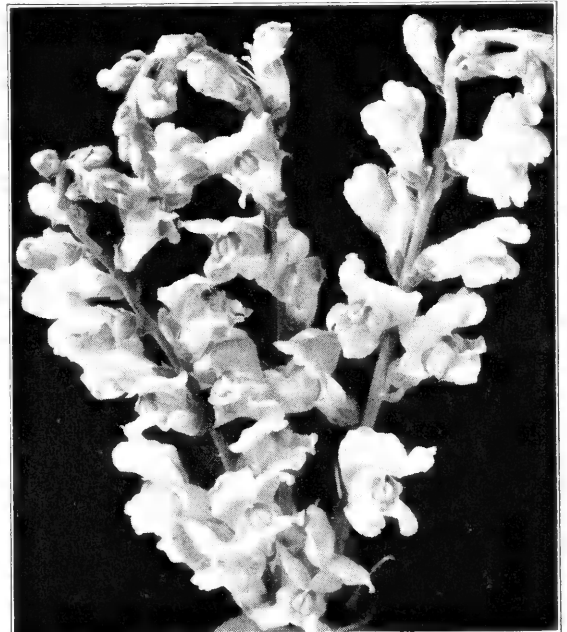

Antirrhinum

Asters - Superior Strains

NOTICE: Varieties marked with asterisk (*) are wilt-resisting.

No.		Pkt.
EARLY GIANT WILT-RESISTANT.		
576	Rose Marie. Rich lively rose flowers 4 to 5 inches in diameter with broad, graceful petals. Plants 1½ to 2 feet tall with branches low on central spike. ¼ oz. 75c	\$0.25
578	Light Blue ¼ oz. 60c	.25
580	Peach Blossom ¼ oz. 60c	.25

AMERICAN BRANCHING, "LATE." Superb free flowering strain, with long, strong stems and very large, graceful chrysanthemum-like flowers, double to the center. By successive sowings they may be had in bloom from Aug. to late fall. 2 to 2½ ft.

585*	Lavender ¼ oz. 85c, oz. \$3.00	.10
595*	Purple ¼ oz. 85c, oz. 3.00	.10
600*	Rich Crimson ¼ oz. 85c, oz. 3.00	.10
605*	Rose-Pink ¼ oz. 85c, oz. 3.00	.10
610*	Shell-Pink ¼ oz. 85c, oz. 3.00	.10
615*	Snow-White ¼ oz. 85c, oz. 3.00	.10
620*	Mixed. All colors ¼ oz. 85c, oz. 3.00	.10
625*	Collection of Six Colors50

KING. Flowers of great size and substance lasting longer when cut than any other class; the long, narrow petals are folded lengthwise, giving somewhat of a quilled appearance. They bloom with the late branching. 2 to 2½ ft.

630*	Crimson. Rich crimson ¼ oz. 60c	.15
635	Lavender ¼ oz. 60c	.15
638*	Peach Blossom ¼ oz. 60c	.15
640*	Rose. Bright, deep rose ¼ oz. 60c	.15
645*	White. Snow-white ¼ oz. 60c	.15
650*	Violet. Rich violet-purple ¼ oz. 60c	.15
652	Mixed ¼ oz. 60c	.15

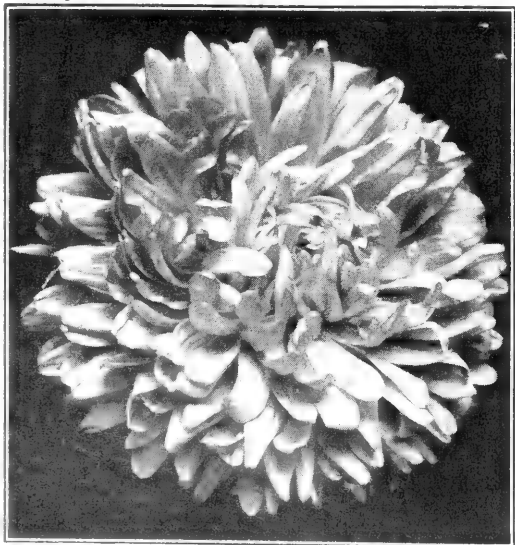

American Late Branching Aster

No.		Pkt.
ROYAL. A class with broad, incurved petals, possessing all the characteristics of the late branching, but not quite so tall. Bloom with the midseason varieties. 1½ to 2 ft.		
660*	Dark Lavender ¼ oz. 60c	\$0.15
662*	Lavender-Pink ¼ oz. 60c	.15
665*	Purple. Rich, deep purple ¼ oz. 60c	.15
666*	Rose ¼ oz. 60c	.15
670*	Shell-Pink ¼ oz. 60c	.15
675*	White. Glistening white ¼ oz. 60c	.15
678*	Mixed ¼ oz. 60c	.15

DOUBLE CALIFORNIA GIANTS. A variety of Aster of the improved Comet type. Very strong stems. Petals beautifully curved and twisted. 3 ft.

680	Collection of 11 colors, separate	1.00
685*	Dark Purple ¼ oz. 85c	.25
690	Deep Rose ¼ oz. 85c	.25
692	El Monte. New Super Giant. Deep glowing crimson ¼ oz. 85c	.25
695	Light Blue ¼ oz. 85c	.25
698	Los Angeles. New Super Giant Shell-pink. ¼ oz. 85c	.25
700	Peach Blossom ¼ oz. 85c	.25
705	White ¼ oz. 85c	.25
710	Mixed ¼ oz. 85c	.25

CREGO'S GIANT COMET. Branching sort with large, full, fluffy flowers—through August and September. 2½ ft.

711*	Azure-Blue ¼ oz. 60c	.15
711A*	Cattleya ¼ oz. 60c	.15
712*	Crimson ¼ oz. 60c	.15
714*	Enchantress. New salmon-rose. ¼ oz. 85c	.25
715	Lavender ¼ oz. 60c	.15
716	Egyptian Rose. Deep cinnabar . . ¼ oz. 60c	.15
720*	Purple. Fine color ¼ oz. 60c	.15
725*	Pink. Soft shell-pink ¼ oz. 60c	.15
730*	Rose. Clear, bright rose ¼ oz. 60c	.15
735*	White. Pure snow-white ¼ oz. 60c	.15
736	Mixed ¼ oz. 60c	.15

OSTRICH PLUME, Improved. Enormous flowers on long stems. The petals are curled and twisted, blooming in August and September. 2½ ft.

740	Collection of following 6 colors, separate.	.75
745*	Crimson ¼ oz. 60c	.15
750*	Dark Purple ¼ oz. 60c	.15
755*	Lavender ¼ oz. 60c	.15
760*	Rose-Pink ¼ oz. 60c	.15
765*	White ¼ oz. 60c	.15
770*	Shell-Pink ¼ oz. 60c	.15
775*	Finest Mixed ¼ oz. 60c	.15
800	Lilliput Flowered Mixed. Plants 14-16 in. bearing an abundance of small button-like flowers ¼ oz. 85c	.15
810*	BLUE FLAME. Bright navy-blue flowers. Plant of the Comet type, 2½ ft. high. ¼ oz. 60c	.15

Asters - Grey's Superior Strains



Grego's Giant Comet Asters

ASTERS—Continued.

No.		Pkt.
825*	GOLDEN SHILLIP. 2 feet. Aurora type of Aster with fully double deep yellow flowers with crest-like center, of good substance and fine depth of petal	1/2 oz. 60c \$0.15
830	IMBRICATED POMPON MIXED. Plants of upright habit, 14-16 inches high with small, round, pompon flowers. Very early	1/2 oz. 75c .15
	QUEEN OF THE MARKET. The earliest flowering, first class Aster, coming into bloom 3 to 4 weeks earlier than other sorts. 1 1/2 ft.	
895	Collection of the following 5 colors50
898*	Bright Violet	1/4 oz. 75c, oz. \$2.00 .10
900*	Crimson	1/4 oz. 75c, oz. 2.00 .10
905*	Dark Blue	1/4 oz. 75c, oz. 2.00 .10
910*	Flesh-Pink	1/4 oz. 75c, oz. 2.00 .10
915*	Light Blue	1/4 oz. 75c, oz. 2.00 .10
920*	Rose	1/4 oz. 75c, oz. 2.00 .10
925*	White	1/4 oz. 75c, oz. 2.00 .10
930*	Mixed. All colors	1/4 oz. 75c, oz. 2.00 .10
	EARLY AMERICAN BEAUTY. A fine, strong growing Aster with incurved petals. Blooms from July to frost. 2 1/2 to 3 ft.	
945*	Azure Fairy	1/2 oz. 60c .15
948*	Crimson	1/2 oz. 60c .15
955*	Purple	1/2 oz. 60c .15
960*	Rose	1/2 oz. 60c .15
965*	Shell-Pink	1/2 oz. 60c .15
970*	White	1/2 oz. 60c .15
975*	Mixed	1/2 oz. 60c .15

No.	OTHER ASTERS	Pkt.
976*	Ball Purple Early	1/2 oz. 75c \$0.20
977*	Ball White Early. Branching	1/2 oz. 75c .20
978*	Heart of France. A pure red Aster. Very double, of strong, branching habit. It keeps its brilliant rich color when cut.	1/2 oz. 75c .15
	SINGLE GIANTS OF CALIFORNIA. Flowers 3 to 4 inches across with stems 1 1/2 to 2 feet in length. The petals are slightly twisted.	
981	Light Blue	1/2 oz. 40c .10
991	Purple	1/2 oz. 40c .10
996	Rose	1/2 oz. 40c .10
1001	White	1/2 oz. 40c .10
1006	Finest Mixed	1/2 oz. 40c .10
	CALIFORNIA SINGLE GIANT IMPROVED "SUNSHINE." Crested flowers with golden centers; strong growing, with flower stems 2 ft. and over in length.	
1018	Mixed colors	1/2 oz. 60c .20
1019	Alpenglow. Purple, yellow center	1/2 oz. 60c .20
1020	Blue Moon. Blue, yellow center.	1/2 oz. 60c .20
1021	Lavender. Lemon center	1/2 oz. 60c .20
1022	Moonbeam. White, orange center.	1/2 oz. 60c .20
1023	Rainbow. Rose-pink, orange center	1/2 oz. 60c .20
1025	Shell-Pink. White and lemon center	1/2 oz. 60c .20
1026	Stratosphere. Dark blue, orange center	1/2 oz. 60c .20
1027	White. Lemon center	1/2 oz. 60c .20
	SINGLE ASTER ELEGANCE.	
1028*	General Joffre. Large single aster of intense crimson-scarlet, on long stems. Excellent for cutting	1/2 oz. 40c .10
	SOUTHCOTE BEAUTY SINGLE. 2 ft.	
1030	Dark Blue15
1032	Mauve15
1035	Rose15
1038	Scarlet15
1040	White15
1045	Mixed15
1048	Collection 5 colors60
	ASTER, Perennial Sorts (Michaelmas Daisies). We have in this class some of the most beautiful and interesting hardy plants grown; their graceful habit, profusion of bloom and variety of color form the chief attraction of the flower garden during the autumn months.	
1050	alpinus speciosus. Large, rich purple.25
1055	Warburg Star, subcoeruleus. Extra large, bright lavender-blue, yellow centers. Flowers 4 inches across, long stems. Extra early. 2 ft.25
1060	White Queen. Large white25
1065	Mixed Hybrids, New Large-Flowered Strain. 2 to 4 ft.	1/4 oz. \$1.75 .25

No.		Pkt.	No.		Pkt.
	AUBRIETIA. These dwarf, hardy perennials are invaluable for the border, rockeries, etc.; they are among the brightest and most free flowering plants of early spring.			BEGONIA, Tuberous-rooted. These are easily grown from seed and may be had in bloom in about 6 months. They make a gorgeous display throughout the season and are excellent for bedding purposes, window boxes, etc., and as pot plants are effective for house and conservatory. 1 ft.	
1070	graeca. Beautiful purple color	\$0.25	1142	Blackmore & Langdon's Double Mixed	\$1.00
1075	leichtlini. Rosy red, very pretty25	1145	Single, Giant Mixed50
	AURICULA. See <i>Primula auricula</i> .		1147	Blackmore & Langdon's Single Mixed	1.00
	BACHELOR BUTTON. See <i>Centaurea</i> .		1152	Blackmore & Langdon's Extra Frilled Mixed	1.00
	BALSAM. These old-fashioned annuals, so easily grown, are again increasing in popularity, and most beautiful and brilliant effects may be had from them; overcrowding should be avoided and they should be set at least 18 inches apart for best results.		1154	Blackmore & Langdon's Basket Begonia Mixed	1.00
1076	Bush Flowered Torch. Dwarf, brilliant vermilion red20		BEGONIA, Fibrous-rooted. The following sorts are perpetual bloomers and extensively used for planting outside in beds and for pot culture in the greenhouse. 1 ft.	
1078	Bush Flowered Mixed15	1155	gracilis, White Pearl. Pure white25
1080	Columbia Prize. An unsurpassed strain in doubleness, size, brilliancy and variety of color	¼ oz. 75c .15	1160	Bonfire. Lustrous carmine, with brownish red foliage25
1085	Dark Blood Red. Extra	¼ oz. 50c .10	1170	luminosa compacta. Dark scarlet25
1090	Intense Scarlet (The King) ...	¼ oz. 50c .10	1172	Prima Donna. Rose, carmine shaded..	.25
1095	Rich Pink (Salmon King)	¼ oz. 50c .10	1175	rosea. Fine rose-pink25
1100	White (Snowball). Superior ...	¼ oz. 50c .10	1180	erfordi, Glory of Erfurt. Lovely rose-carmine flowers, with dark, glossy, green foliage50
1105	Mixed Rose-flowered. Very double	¼ oz. 40c .10	1185	Salmon Queen. Brilliant salmon-red, passing to salmon-rose; the dark green foliage has a reddish hue50
1110	BALLOON VINE. A rapid growing annual climber, with white flowers and inflated seed vessels which look like miniature balloons	oz. 50c .10	1195	Vernon, Deep scarlet, with bronze foliage.	.25
1115	BAPTISIA australis (False Indigo). Handsome hardy perennial, producing bright blue, pea-shaped flowers on spikes 6 inches long. 2 ½ ft.	¼ oz. \$1.00 .15	1200	Vernon, Dwarf. Rich red, with glossy bronze foliage. 1 in.25
1120	BAETONIA aurea. Showy, hardy annual of distinct character, its large golden yellow flowers being freely produced; succeeds well in partial shade. 1 ½ ft.	¼ oz. 50c .15	1208	Semperflorens, Gustave Knaake. Glowing salmon-pink, leaves green. Excellent for pot culture35



Balsam, Bush Flowered, Torch



Begonia, Fibrous-Rooted

No.		Pkt.
	BELLIS perennis fl. pl. (Double Daisy). Favorite perennials producing in Spring their handsome, double flowers, and are very effective when planted with Pansies or Forget-me-nots. Rich soil and cool situation suit them best.	
1220	monstrosa, Rose. Extra large. ¼ oz. \$1.00	\$0.25
1225	monstrosa, White. Extra large. ¼ oz. \$1.00	.25
1228	monstrosa, Red. Extra large. ¼ oz. \$1.00	.25
1230	Quilled, Giant Red. Dark red	.25
1240	monstrosa, Finest Mixed. Double. ½ oz. \$1.00	.15
1245	BOCCONIA japonica (Plume Poppy, or Tree Celandine). 5 ft. Ornamental, hardy perennial, with glaucous green foliage and spikes of creamy white flowers	.15
1250	BOLTONIA latisquama. Hardy perennials, with large clusters of lavender-pink, daisy-like flowers. 5 ft.	.25
	BROWALLIA. Beautiful, profuse blooming bedding and pot plants. 1½ to 2 ft.	
1255	speciosa major. Large, brilliant, ultramarine blue; splendid winter bloomer.	.35
1260	Mixed Elata. Shades of blue and white. ¼ oz. 50c	.15
1262	Elata. Blue	.15
	BRACHYCOME (Swan River Daisy). Profuse flowering, low growing annual, with pretty Daisy-like flowers; doing best in warm and dry situations. 9 in.	
1270	Blue Star. Beautiful bright blue. ¼ oz. 50c	.15
1275	rosea. Fine color	.15
1280	Mixed	.10
1285	CACALIA coccinea (Tassel Flower). A neat, free blooming annual, with scarlet tassel-like flowers. All summer. 1½ ft.	.10
1290	CACTUS. Succulent plants. Excellent mixture of American grown varieties, suitable for growing in pots in house	.25



Calendula Chrysantha

No.		Pkt.
	CALCEOLARIA. Our seeds are from noted English growers and saved from the finest strains grown, which have been awarded the leading prizes.	
1295	Covent Garden Strain. Extra choice, strongly recommended for habit, size and marketing of flowers	\$0.75
	Hybrida multiflora nana. Plants 10-12 in. in height, producing masses of little ball-shaped flowers.	
1296	Deep Crimson. Dark velvety shade	.75
1297	Golden Tiger. Profuse golden yellow flowers with dark brownish red dots	.75
1298	Splendid Mixed	.75
1300	KELWAY'S Perfect Model. Medium height. Of splendid habit. Heads of very large flowers. The richest colors	1.00
1301	rugosa or Shrubby, Mixed	.50
	CALENDULA officinalis fl. pl. (Pot Marigold). Valuable, hardy annual, the double showy flowers making a grand display for months; suitable for dry places. 1½ to 2 ft.	
1303	Art Shades. Contains apricots, picotees, orange and cream tones. ¼ oz. 40c	.15
1304	Ball's Apricot. Brown center	.15
1306	Ball's Gold. Deep golden	.15
1307	Ball's Orange. Light center	.15
1308	Campfire (Sensation). Dark orange. Light center	.15
1309	Chrysantha. Clear buttercup- yellow	.15
1310	Lemon Queen (Ball's)	.15
1311	Lemon Shaggy. Long, deeply fringed petals	.15
1312	Masterpiece. Deep orange, brown center.	.15
1320	Orange King. Large, dark orange.	.10
1326	Orange Sunshine. Chrysanthemum type	.15
1328	Radio, Golden Beam. Orange, quilled	.10
1329	Yellow Colossal. Chrysantha type. Bushy, 18-inch plants loaded with double clear light lemon-yellow blooms 4½ inches and more across	.25
1330	Mixed. Double, all shades	.10

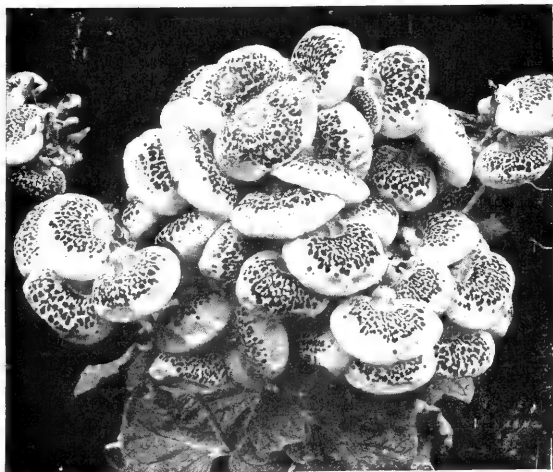

Calceolaria, Golden Tiger



Calliopsis, Gold Crest

No.		Pkt.
	CALLIOPSIS, or COREOPSIS. Showy, hardy annuals, very continuous in flowering, and most useful for cutting.	
1335	coronata maxima. Large yellow. ¼ oz. 40c	\$0.10
1340	drummondii (Golden Wave). Golden yellow, with brown center . . . ¼ oz. 40c	.10
1345	Fire King. Deep, bright scarlet, cactus-shaped petals15
1348	Gold Crest. Semi-double. Golden-yellow with reddish brown zone15
1352	Golden Bay. 10 in. Gold, maroon center. .	.15
1353	Star of Fire. 10 in. Garnet-brown15
1354	Tiger Star. 10 in. Yellow and maroon . .	.15
1355	Mixed. Fine varieties. ¼ oz. 25c,	oz. 75c .10
	CALLIOPSIS, or COREOPSIS. Hardy Perennial Varieties. Early sown seed will bloom the same season, but it is better to sow in July and protect lightly in winter.	
1360	Double Sunburst. Golden-yellow25
1365	Mayfield Giant. California strain. Large golden yellow flowers . . ¼ oz. \$1.00	.25
1330	CALLIRHOE involucreat (Poppy Mallow). Perennial of spreading growth, with large, bright crimson saucer-shaped flowers15
	CAMPANULA (Bellflower). Beautiful well-known hardy perennial and one of our most attractive garden flowers, noted for their rich colors and profusion of bloom.	
1385	carpatica. Erect blue flowers all summer; 9 in.	¼ oz. \$1.00 .15
1390	carpatica alba. 9 in.	¼ oz. \$1.00 .15
1394	lactiflora coerulea. Tall, light blue25

CAMPANULA—Continued.		
No.		Pkt.
1400	moerheimi. Large, white, saucer-shaped flowers. 2 ft.	½ oz. \$1.50 \$0.25
1405	persicifolia grandiflora. Large, bright blue; one of the best. 2 ft. . . ½ oz. 85c	.25
1410	persicifolia grandiflora alba. . . . ½ oz. 85c	.25
1418	persicifolia grandiflora. Telham Beauty. Largest blooms of soft lavender. 2½ ft. .	.50
1420	persicifolia grandiflora. Mixed25
1425	pyramidalis (Chimney Bellflower). Blue. 4 ft.	½ oz. 60c .15
1430	alba. White. 4 ft.	½ oz. 75c .15

Canterbury Bells

Annual Varieties. Plant grows from 2 to 2½ feet high, each plant having from 6 to 8 spikes of blooms. Seeds planted in February bloom in July.

1436	Angelus Bell. Deep rose15
1436A	Blue Bell. Light blue15
1437	Liberty Bell. Violet-blue15
1438	Wedding Bell. Pure white15
1439	Mixed15

CAMPANULA medium (Canterbury Bells). Showy, hardy biennials, about 3 ft. high, of pyramidal form, and profusely covered with large, bell-shaped flowers. **calycanthema** (Cup-and-Saucer Varieties).

1440	Blue	¼ oz. \$1.00 .15
1445	Rose-Pink	¼ oz. \$1.00 .15
1450	White	¼ oz. \$1.00 .15
1455	Mixed. All colors	¼ oz. \$1.00 .15
1460	Single, Blue	¼ oz. 50c .10
1465	Rose-Pink	¼ oz. 50c .10
1475	Mauve	¼ oz. 50c .10
1480	White	¼ oz. 50c .10
1485	Mixed. All colors	¼ oz. 50c .10
1490	Double, Blue	¼ oz. \$1.00 .15
1495	Rose-Pink	¼ oz. \$1.00 .15
1500	White	¼ oz. \$1.00 .15
1505	Mixed. All colors	¼ oz. \$1.00 .15
1510	Columbia, Prize Mixture. All colors of all varieties, unsurpassed . . . ¼ oz. \$1.00	.25
1512	Dwarf Bedding Mixed. New type about 20 inches in height, forming bushes over 3 feet in circumference, often bearing 100 to 150 flowers25

CANDYTUFT. Fine for edgings and cut flowers. Hardy annual. 1 ft.

1515	Carmine. Carmine-rose. ¼ oz. 40c, oz. \$1.50	.15
1520	Crimson	¼ oz. 25c, oz. 75c .15
1525	Dobbies White Spiral.	¼ oz. 50c .10
1530	Empress. Pure white, pyramidal trusses	¼ oz. 35c, oz. \$1.10 .10
1532	Flesh-Pink	¼ oz. 40c .10
1535	Giant Perfection. Immense, pure white spikes. Special selection	¼ oz. 60c, oz. \$2.00 .15
1536	Lavender	¼ oz. 20c, oz. 50c .10
1542	Rose Cardinal Improved	¼ oz. 50c .15
1545	Giant Mixed. All colors . ¼ oz. 15c, oz. 40c	.15
1550	Dwarf Rose	¼ oz. 60c, oz. \$1.75 .15
1555	Dwarf White	¼ oz. 60c, oz. \$1.75 .15
1556	Dwarf Flesh-Pink	¼ oz. 60c .15
1558	Dwarf Crimson	¼ oz. 60c .15
1560	Dwarf Mixed Hybrids. ¼ oz. 50c, oz. \$1.50	.10
1561	CARDINAL CLIMBER. Large, brilliant cardinal-red flowers in clusters, all summer15

CARNATIONS—Annual Varieties

No.		Pkt.
	CARNATION PERPETUAL GIANT. 16 to 20 inches. A strain similar in habit and earliness to Chabaud's Giant Improved but with extra large flowers. The flowers are one-third larger than Chabaud's Giants. Very double and strongly clove scented.	
1562	Band Red. Dark crimson	\$.025
1563	Canary Yellow. Clear yellow	.25
1564	Mont Blanc. Pure white	.25
1565	Rose King. Rose-pink	.25
1566	Rose Supreme. Flesh-pink	.25
1567	Salmon Glory. Salmon-rose	.25
1568	Spectrum Red. Intense scarlet	.25
1569	Violet Queen	.25
1570	Choice Mixed	.25
1571	Collection 8 Varieties	1.50
	Separate Colors or Mixed, 1/16 oz. 75c.	
1592	Chabaud's Giant Improved French Carnation. Half hardy perennial. Seed sown early inside will bloom in six months. Clove-scented. Finest Mixed. 1/8 oz. 50c	.15
1573	Marguerite, Giant Mixed. Improved and very large, double-flowered strain of this early flowering Carnation which blooms in four months from time of sowing	1/8 oz. 50c .15
1574	Giant Rose	1/8 oz. 50c .15
1575	Giant Scarlet	1/8 oz. 50c .15
1576	Giant Yellow	1/8 oz. 50c .15
1577	Giant White	1/8 oz. 50c .15
	CELOSIA cristata, or COCKSCOMB. Free blooming annuals; large, brilliant Cockscomb-like heads. They prefer light soil, not too rich; fine border or pot plant.	
1580	Dwarf Bright Rose. 3/4 ft. 1/8 oz. \$1.00	.15
1585	Copper Color. 3/4 ft. 1/8 oz. \$1.00	.15
1590	Dark Blood-Red. 3/4 ft. 1/8 oz. \$1.00	.15
1595	Glasgow Prize. Dark crimson	.15
1600	Golden Yellow. 3/4 ft. 1/8 oz. \$1.25	.15
1610	Mixed. Finest colors. 3/4 ft. 1/8 oz. 75c	.10
1615	Tall Mixed. All colors. 2 to 3 ft. 1/8 oz. 20c	.10

CELOSIA thompsoni magnifica, Improved Feathered Cockscomb. A magnificent and valuable annual, with long, feathery plumes of the richest colors, varying from pale yellow to the deepest crimson. Effective during summer and fall. 2 ft.

1625	Crimson	1/8 oz. 50c .15
1630	Golden Yellow	1/8 oz. 50c .15
1640	Scarlet	1/8 oz. 50c .15
1645	Triumph of Exposition. Crimson, dark red stems	1/8 oz. 50c .15
1650	Mixed. All colors	1/8 oz. 50c .15
1652	Heatherdell Fiery Feather. Ostrich Plume variety about 12 in. high; blooms from early August until frost. Also good in the greenhouse	.25
1654	Heatherdell Golden Feather.	.25
1656	Pyramidal Flame of Fire. Fine dwarf fiery red	.25

CENTAUREA (Dusty Miller). Silver foliaged plants used for edgings, baskets, etc. Half-hardy perennial.

1665	candidissima. Thick foliage. 1/8 oz. 50c	.15
1670	gymnocarpa. Very graceful. Fernlike foliage. 1/4 oz. 50c	.15
1675	americana. Reddish lilac. 2 ft. 1/4 oz. 60c	.15
1676	americana alba. 2 ft. 1/4 oz. 75c	.20

CENTAUREA—Continued
CYANUS. BACHELOR BUTTON, CORNFLOWER

No.		Pkt.
1678	Dwarf Jubilee Gem. 1 ft. Compact and covered with vivid double blue flowers.	\$.015
1685	Double Mixed	1/4 oz. 30c .10
1695	Double Blue Boy	1/4 oz. 30c .10
1696	Double Carmine	1/4 oz. 30c .10
1697	Double Maroon	1/4 oz. 30c .10
1698	Double Mauve	1/4 oz. 30c .10
1705	Double Rose	1/4 oz. 30c .10
1710	Double White	1/4 oz. 30c .10
	IMPERIALIS (Royal Sweet Sultan). Very large, sweet scented flowers. 2 to 3 ft.	
1715	Bright Pink	1/4 oz. 40c .15
1720	Dark Purple	1/4 oz. 40c .15
1728	Lavender Beauty	1/4 oz. 40c .15
1735	White	1/4 oz. 40c .15
1740	Mixed. All colors	1/4 oz. 40c .15
1765	suaveolens. Yellow	1/4 oz. 30c .10
	CENTAUREA, Perennial Varieties. Showy thistle-like flowers from July to September.	
1770	macrocephala. Large yellow. 3 ft.	.15
1775	montana. Deep purple. 2 ft. 1/4 oz. 75c	.15
1780	alba. Large white. 2 ft. 1/4 oz. 75c	.15
1785	CHARIETS heterophylla (Kaufussia ameloides). Big lavender-blue daisies in continuous bloom. Easy growing annual for edgings, rock gardens or beds. 8 to 10 inches	.20
1790	CERASTIUM tomentosum (Snow-in-summer). A white foliaged hardy perennial, with small, white flowers; 4 in.	.25
1792	CHEIRANTHUS allioni (Siberian Wallflower). Excellent dwarf perennial for rockery or border; brilliant orange. 1 foot	1/4 oz. 75c .20
1793	Allioni, Golden Bedder. Flowers are fragrant and long lasting. 1 foot	.25
1794	linifolius (Alpine Wallflower). Dwarf, mauve, fragrant. 1 ft.	.25
	CHELONE. Pentstemon-like spikes of brilliant colored flowers from July to October. Hardy perennial. 2 ft.	
1795	barbata torreyi. Scarlet	1/8 oz. 75c .15



Carnations



Shasta Daisy, Alaska

No.		Pkt.
	CHRYSANTHEMUM. Showy and effective summer flowering plants, blooming from July until frost; very desirable for the garden and for cut flowers.	
	Double-flowering Annual Varieties. 2 ft.	
1805	Golden Yellow ¼ oz. 40c.	\$.15
1807	Golden Crown. 3 to 4 ft. 50 to 60 blooms on a plant. Foliage silvery green; 100 per cent double with quilled petals of bright butter-yellow 25	
1808	Scarlet ¼ oz. 40c	.15
1810	White ¼ oz. 40c	.15
1812	Yellowstone (Segetum Double).....	.25
1815	Mixed. All colors ¼ oz. 40c	.10
1820	Fringed Hybrids. All colors ¼ oz. 50c	.15
	Single-Flowering Annual Varieties. 2 ft.	
1825	atrococcineum. Scarlet ¼ oz. 25c	.10
1830	Evening Star. Large golden. ¼ oz. 25c	.10
1832	Eastern Star. Primrose-brown disc ... ¼ oz. 25c	.10
1833	Golden Glory. Deep golden yellow ... ¼ oz. 25c	.10
1835	Morning Star. Large primrose ¼ oz. 25c	.10
1838	Nivelli. Annual yellow Marguerite ... ¼ oz. 25c	.10
1840	Northern Star. Large white, yellow center, with dark disc ¼ oz. 25c	.10
1845	Mixed. All colors Oz. 60c	.10
1850	Grey's Special Mixture. All colors in double, single and fringed ... ¼ oz. 60c	.15
1852	Cascade, or Balcony. Annual. Large clusters of small single flowers. Plant is of the trailing type and attractive in a window box or pot 25	
	CHRYSANTHEMUM, Perennial Varieties.	
1855	frutescens (Paris Daisy). Single white, fine for winter blooming. 1½ ft.15
1856	Inodorum, Bridal Robe. Dwarf, compact small double white flowers 25	
1857	Indicum. Early flowering, double and semi-double. Flowers 5 months after sowing 25	
1858	Korean Hybrids. A wonderful range of magnificent colors. Large flowering single and semi-double 50	
1860	Mawii. Rich rose-pink flowers on a dwarf plant. Ideal for borders or rockeries. . 35	

No.		Pkt.
	CHRYSANTHEMUMS—Continued	
1870	Shasta Daisy, Alaska. One of the best hardy white flowers for cutting; large, single \$0.25	
1872	Shasta Daisy, Double White. Semi-double and double fringed 35	
1875	Pompon-flowered. The double, small-flowered hardy sorts; fine colors 25	
	CINERARIA. One of the most beautiful plants for house or conservatory during the spring months. Seeds should be sown from May to September.	
	multiflora grandiflora maxima. A hybrid between "multiflora nana" and "grandiflora" having blooms of the grandiflora and many flowers of multiflora nana. 12 to 16 inches above the pot.	
1876	Rose 1.00	
1879	Dark Red 1.00	
1881	Cornflower Blue. Deep blue 1.00	
1883	White 1.00	
1884	Mixed 1.00	
1885	Grey's Exhibition Prize. Acknowledged by our customers to be the finest strain grown; of compact branching habit, with exceptionally large flowers of the richest and brightest colors. 1.00	
1886	Cremer's Prize Strain Mixed 1.00	
1888	grandiflora alba. Large pure white75	
1890	atrosanguinea. Large blood red75	
1895	azurea. Large, light blue75	
1898	Dark Blue75	
1902	Matador. Glowing scarlet75	
1905	Pink shades. Very fine75	
1910	Dwarf Large-flowering Mixed. Dwarf, compact habit with immense trusses .. multiflora nana compactum. 10 inches. . 75	
1911	Dark Blue75	
1912	Deep Red75	
1913	Lavender75	
1914	Light Blue75	
1915	Pure White75	
1916	Pink75	
1917	Rose75	
1918	Mixed75	
1919	stellata, Feltham Beauty. Extra mixed... . 75	
1920	stella grandiflora. Large flowers, with twisted or fluted petals 75	
1925	maritima candidissima, Diamond (Dusty Miller). White foliage ¼ oz. 35c . 15	
	CLARKIA. Very showy and profuse flowering hardy annuals of easy culture; very useful for cutting. 3 ft.	
1928	Double Appleblossom ¼ oz. 35c . 15	
1931	Crimson Queen ¼ oz. 35c . 15	
1932	Enchantress. Salmon-pink ¼ oz. 35c . 15	
1935	Orange King. Orange-scarlet. ¼ oz. 35c . 15	
1940	Purple Prince. Rich purple. ¼ oz. 35c . 15	
1945	Queen Mary. Rose-carmine . ¼ oz. 35c . 15	
1952	White ¼ oz. 35c . 15	
1955	Mixed. Extra fine colors ¼ oz. 25c . 10	
1975	CLEOME pungens (Spiderflower), Rose Queen. Flowers rose with long stamens ½ oz. 35c . 15	
1985	COBAEA scandens. Popular climber of rapid growth, with large, purple, bell-shaped flowers; blooms first season from seed which should be planted edgewise. 20 ft. ¼ oz. 30c, oz. 1.00 . 15	
1990	scandens alba. White flowered. 25	



Dahlia, Coltness

No.		Pkt.
	COCKSCOMB. See <i>Celosia</i> .	
	COLEUS. Ornamental foliage plants, easily grown from seed. Half hardy perennial.	
2005	Mixed Hybrids. From a large collection..	\$0.15
2010	New Large-leaved Varieties. Extra fine...	.25
2015	COLLINSIA, Mixed. Free flowering, hardy annuals suited to dry situations10
2020	COMMELINA coelestis. Half hardy tuberous-rooted perennial, with sky-blue flowers; blooms first season. 1½ ft.....	.15
2022	CONVOLVULUS, Crimson Rambler. Beautiful climber, dark red flowers with white throat15
2025	minor, Mixed. Handsome, hardy annual, with large, richly colored flowers, producing a brilliant effect. 1 ft. .Oz. 40c	.10
	COSMOS. One of the most beautiful and useful of the hardy annuals, producing through the season thousands of beautiful flowers. Seed should be sown in May in the open ground.	
	Double Crested. Early blooming.	
2026	Carnelia. Crimson	¼ oz. 85c .25
2027	Peach Blossom. Pink	¼ oz. 85c .25
2028	Whirlwind. White	¼ oz. 85c .25
2029	Finest Mixed	¼ oz. 85c .25
2030	Extra Early, Mammoth Midsummer, Mixed. The blossoms, under ordinary field cultivation, average 4 to 5 inches across, surpassing in size any of the late varieties	¼ oz. 40c .15
2035	White. 4 ft.	¼ oz. 40c .15
2040	Pink. 4 ft.	¼ oz. 40c .15
2045	Crimson. 4 ft.	¼ oz. 40c .15

No.		Pkt.
	COSMOS, SENSATION. Immense flowers 4 to 5 inches in diameter, with broad, fluted, overlapping petals. Plants 3 to 4 feet high. Early flowering.	
2050	Mixed Colors	¼ oz. 75c \$0.25
2051	Cardinal. Crimson	¼ oz. 75c .25
2052	Pinkie. Rose-pink	¼ oz. 75c .25
2054	Purity. Glistening white	¼ oz. 75c .25
2055	Double Sensation Extra Early Mixed. Similar to single in height and characteristics. Average 4½-5 in. across25
	Mammoth. Late flowering. 5 ft.	
2060	Lady Lenox. Shell-pink	¼ oz. 40c .10
2065	Lady Lenox. White	¼ oz. 40c .10
2070	Klondyke Early Orange Flare. In bloom in less than 4 months from sowing ...	⅛ oz. 30c .15
2085	CUPHEA platycentra (Cigar Plant). Bright scarlet, tubular flowers, tipped with black; blooms freely from seed. 1 ft..	.25
2080	Firefly. Dwarf, compact, fiery cerise-red.	.35
	CYCLAMEN. The seed is saved by a leading specialist from selected strains of the very best varieties, and produces flowers of the largest size, finest substance and most charming shades of color. July to August is the best time for sowing. Seedlings should be grown on without any check, and grown cool.	
2105	Giant America. Imp. Salmon-scarlet....	.75
2110	Blood Red75
2111	Bonfire75
2138	Lavender. Self color, very large.....	1.00
2139	Mozart. New deep pink.....	1.00
2140	Orange Beauty.	1.00
2142	Pink Pearl. Large, pale salmon.....	1.00
2143	Perle of Zehlendorf. Deep salmon.....	.75
2150	Pure Rose. Rich color.....	.75
2152	Rose of Marienthal. Pink, red eye.....	.75
2157	Rose of Zehlendorf. Light salmon.....	.75
2160	Saffron. Red	1.00
2161	Saffron. Silver edge	1.00
2162	White75
2165	White, Carmine Eye75
2170	New Ruffled Giants, Mixed.	1.00
2180	Grey's Giant Mixture. All colors75
	For above named Cyclamen, 100 seeds \$2.50, 1000 seeds \$18.00	
2182	CYNGLOSSUM amabile, Blue Bird (Chinese Forget-me-not). Annual. Heavenly blue	.15
2183	Firmament. Bright indigo-blue25
2184	Amabile Pink. Habit same as the above.	.20
	DAHLIA. This popular flower can be easily raised from seed flowering the same season. Seed should be sown early in gentle heat.	
2192	Cactus, Double Mixed.25
2193	Coltness Hybrids, Pink25
2194	Coltness Hybrids, Scarlet25
2196	Coltness Hybrids, White25
2197	Coltness Hybrids, Yellow25
2198	Coltness Hybrids Mixed. 18-24 in. Single..	.25
2199	Coltness Mignon. Very dwarf. Mixed ..	.25
2200	Peony-Flowered Giant25
2205	Pompon, Double Mixed. Small flowered..	.25
2215	Single Giant Perfection. Surpassing all others in size and colors.... ¼ oz. \$1.50	.25
2220	Unwin Dwarf Giant Flowered, Mixed. The flowers are semi-double on long, strong stems, and are borne in profusion on bushy plants25
	DATURA (Trumpet Flower). 3 ft.	
2225	Double Mixed	¼ oz. 35c .15

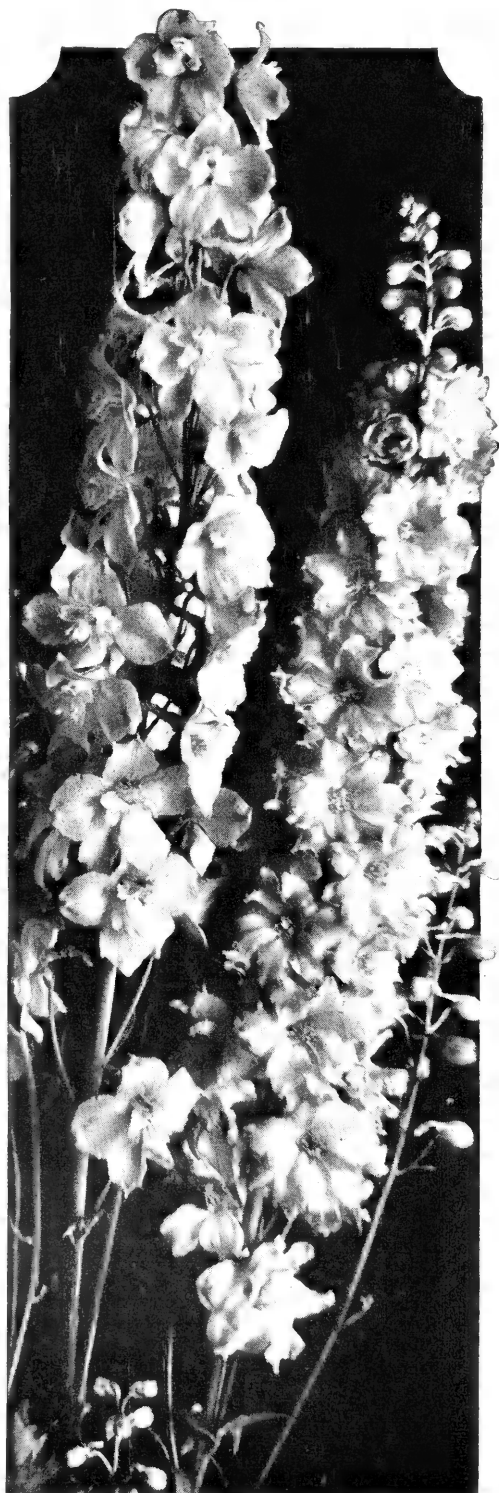

Delphinium, Pacific Giants

No.		Pkt.
	DELPHINIUM chinense (Chinese Larkspur). The Chinese Delphinium blooms from seed the first year if sown early and may be treated as an annual; though it is a hardy perennial and plants will last many years. Fine for beds and border masses.	
2300	Azure Fairy. Clear, light blue, 15 in.	1/4 oz. 50c \$0.15
2301	Blue Gem. Deep blue, 9 to 12 in.	1/8 oz. 50c .15
2365	Blue Butterfly. Bright blue. 15 in.	1/4 oz. 60c .15
2306	Chinese (grandiflorum). Large, deep blue. 1 1/2 ft.	1/4 oz. 50c .10
2307	chinense album. Large white ...	1/4 oz. 50c .10
2308	chinense Cambridge Blue. Clear Belladonna-blue. 2 to 3 ft.	1/4 oz. \$1.00 .25
	DELPHINIUM, Hardy Perennial Varieties	
2310	Columbia Hybrids. An exceptionally fine strain selected from large flowering varieties.	1/4 oz. 85c .25
2312	Blackmore and Langdon's Gold Medal Mixed	1/8 oz. \$1.50 .50
2315	Kelway's Snow, Mixed	1/8 oz. \$1.50 .50
2325	Belladonna Improved. Clear turquoise-blue. If sown early will bloom in late summer and autumn	1/4 oz. \$1.25 .25
2326	Bellamosum Improved. Deep blue	1/4 oz. \$1.25 .25
2330	Hollyhock type Wrexham Hybrids. Long pyramidal spikes. 5 ft.	1/8 oz. \$1.00 .25
	DELPHINIUM, Pacific Giants. A new strain originated on the Pacific Coast. Huge flowers two and one-half to three and one-half inches in diameter, beautifully spaced on well balanced spikes, thin woody stems. Comparatively mildew-resistant, this strain is practically 100 per cent double.	
2349	Black Knight Series. Velvet texture	1.00
2350	Bluejay Series. True blue, dark bee	1.00
2351	Cameliard Series. Lavender, white bee ...	1.00
2352	Galahad Series. Giant white	1.00
2356	King Arthur Series. Royal purple75
2358	Guinevere Series. Pink-lavender75
2360	Summer Skies Series. Blue, white bee75
2362	Clear White50
2364	Lavender Pastel Shades50
2366	Dark Violet Shades50
2368	Light Blues50
2370	Dark Blue50
2371	Round Table Series. Newest colors	1.00
2372	Pacific Giant Strain Mixed50
	DIANTHUS, or PINKS. Annual Varieties. Hardy biennials though treated as annuals, and bloom the first season from early summer until frost.	
	DOUBLE-FLOWERING VARIETIES	
2385	chinensis, Mixed. Indian Pink... 1/4 oz. 40c	.10
2395	heddewigi, Mixed. Japan Pink 1/4 oz. 60c	.10
2400	laciniatus, Mixed. Lace Pink.. 1/4 oz. 60c	.10
2405	latifolius, Mixed. Large flowers, resembling the Sweet William in shades of rose, crimson and maroon.....	1/4 oz. 75c .10
2410	nobilis, Mixed (Royal Pink). Largest size and brightest colors	1/4 oz. 50c .10
2415	Blood Red. Deep color; extra... 1/4 oz. 75c	.10
2425	Salmon Pink (Salmon King)... 1/4 oz. \$1.00	.20
2430	White. Very fine variety.....	1/4 oz. 75c .10
	SINGLE-FLOWERING VARIETIES	
2445	Vesuvius. Brilliant scarlet	1/4 oz. 50c .10
2450	Mixed. Finest colors and sorts. 1/4 oz. 50c	.10
	DIANTHUS caryophyllus (Carnation Pink).	
2455	Riviera Market (Giant of Nice). Superior class of perpetual flowered Carnations.	.50

No.	DIANTHUS—Continued.	Pkt.
2500	DIANTHUS deltooides Brilliant. (Maiden Pink). Beautiful, hardy sort for rockeries, sunken gardens, etc. The flowers are bright pink, small and in abundance from May to Aug. 6 in. ¼ oz. 85c	\$0.15
2505	deltooides albus. White flowers .. ¼ oz. 85c	.15
2508	DIANTHUS (Hardy Carnation) allwoodi. A new race of Hardy Pinks, very free flowering and producing about 75 per cent of double flowers, Mixed colors....	.50
2520	scoticus fl. pl. Perfection. Prize strain of double Scotch or florists' Pinks in finest colors50
2525	DIANTHUS plumarius (Hardy Garden or Clove Pink). Double mixed. Free blooming strain, with double or semi-double flowers of spicy odor; in finest colors	¼ oz. \$1.00 .25
2528	DIASCIA barbarae. 1 ft. coral-pink, Charming little rock garden annual.15
2530	DICTAMNUS, Mixed (Fraxinella). Gas Plant. Very showy, hardy perennial... ¼ oz. \$1.00	.15
2532	DIDISCUS coeruleus (Blue Lace Flower). Hardy annual. 18 in..... ¼ oz. 50c	.15

DIGITALIS (Foxglove). Hardy perennials of easy culture, valuable for shrubby borders, woodland walks, partially shady places. Blooms in June and July. 3 to 4 ft.

2540	grandiflora. Light yellow, fine.. ¼ oz. 35c	.10
2548	Lutzii. Salmon hybrids. 4 ft. .. ¼ oz. 50c	.20
2550	monstrosa, Mixed. Beautiful colors with one enormous flower at top of spike. ¼ oz. 75c	.15
2553	The Shirley. Giant mixed	¼ oz. 85c .20
2555	Gloxiniaeflora, Mixed. All colors. ¼ oz. 40c	.10
2560	Red	¼ oz. 50c .15
2565	Rose	¼ oz. 50c .15
2570	White	¼ oz. 50c .15

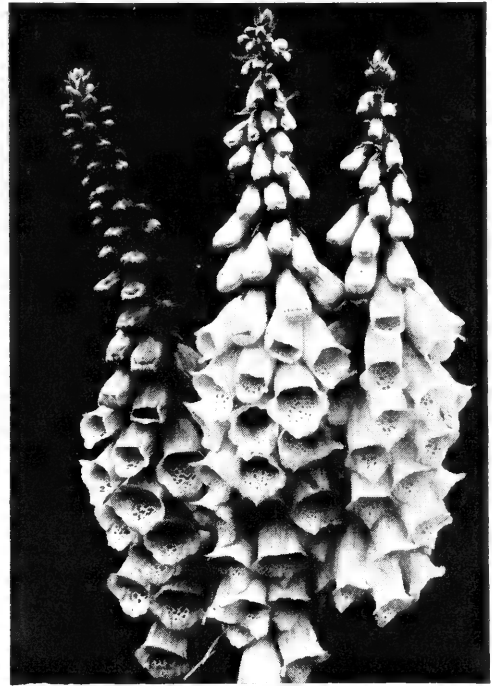

Digitalis, Giant Shirley



Dianthus Deltooides

No.		Pkt.
2575	DIMORPHOTHECA aurantiaca (African Marguerite). Beautiful Transvaal annual, with a profusion of rich orange-gold flowers throughout the season. 15 in. ¼ oz. 75c	\$0.15
2576	Eklonis. Pure white, blue center..... ¼ oz. 60c	.20
2580	New Hybrids. Rich colors	¼ oz. 75c .15
2582	Salmon Beauty	¼ oz. 60c .20
	DOLICHOS (Hyacinth-bean). A beautiful, quick growing annual climber; the seed pods are quite ornamental. 10 ft.	
2595	lablab, Mixed. Purple and white.. Oz. 30c	.10
2596	DORONICUM caucasicum. H. P. Early yellow, 2 ft.50
2598	pardalianches (Bunch of Gold). H. P. 2½ ft. Long-stemmed flowers of bright canary yellow, blooming in May and June.75
	DRACAENA. Decorative plants, with long, graceful foliage; valuable for vases and house decoration; tender perennials.	
2605	indivisa. Narrow green foliage. ¼ oz. 30c	.10
2610	Ornamental Foliage Sorts. Including the best and most brilliant colors.....	.25
2620	ECHINACEA helianthus (Red Perennial Sunflower). Large, purplish red flowers freely produced through the whole summer. 5 ft.15
2630	ECHINOCYSTIS lobata (Wild Cucumber). Rapid growing annual climbers, with ornamental seed pods and large seed. Soak the seed in warm water over night and plant the eye down. 20 ft.. Oz. 50c.	.10

No.		Pkt.	No.		Pkt.
2633	ECHINOPS ritro (Globe Thistle). Blue thistle-like flowers, silvery-white foliage	\$0.15	2692	Golden West . Yellow, orange center.... Oz. 50c	\$0.10
2634	ECHIUM Blue Bedder . A new compact variety about 12 inches high with deep bright blue flowers25	2695	Mandarin . Inside orange, outside scarlet.	Oz. 75c .10
2635	EDELWEISS (Gnaphalium leontopodium). Charming Swiss Alpine plant, with lovely star-shaped, white everlasting flowers25	2705	Rose Queen . Creamy rose.....	Oz. 50c .10
	ERIGEERON (Midsummer Daisy). Effective hardy perennial, May to Oct. 1½ ft.		2708	Tango . Bronzy red overlaid terra cotta.. ¼ oz. 50c	.15
2650	aurantiacus hybridus . Shades of orange and yellow25	2709	The Geisha . Fluted petals, orange-crimson	¼ oz. 50c .15
2655	speciosus hybridus grandiflorus . Large mauve color; excellent for cutting.....	.15	2710	Finest Mixed . All colors	Oz. 50c .10
2660	ERYNGIUM amethystinum . A handsome, hardy perennial, with beautiful foliage and flowers of a lovely blue. Can be dried for winter. July, Aug. 3 ft..... ¼ oz. \$1.00	.25	2712	Ramona Strain Frilled Hybrids . A new, compact erect strain of fluted and frilled blossoms of many beautiful hues	Oz. \$1.00 15
2665	ERYSIMUM, Golden Gem . Golden yellow hardy biennial, like a miniature Wallflower, effective for Spring bedding. ¾ ft.10		EUPATORIUM . Free blooming, hardy perennials. Blooms first season from seed. Aug. to Oct.	
	ESCHSCHOLTZIA (California Poppy). Profuse flowering plants, with bright, showy flowers; excellent for bedding massing or ribbon work. Hardy annual June to Oct. 1 ft.		2720	fraseri . Snow white. 2 ft.....	¼ oz. 1.00 .25
2670	aurantiaca . Orange True California Poppy	Oz. 50c .10	2725	EUPHORBIA heterophylla (Mexican Fire-plant). The beautiful orange-scarlet bracts completely cover the plant almost the entire season. Annual. 2 to 3 ft.	¼ oz. 50c .15
2675	california alba	Oz. 50c .10	2730	variegata (Snow-on-the-mountain). Foliage striped and margined with white. Annual. 1½ to 2 ft.....	Oz. \$1.00 .10
2680	Carmine King . Deepest carmine..	Oz. 75c .10	2735	EXACUM affine . Dwarf, showy, tender annual for pot culture with clusters of fragrant lilac flowers. 1 ft.....	.25
2690	Frilled Pink . Delicate pink	Oz. 75c .10	2738	affine atrocoeruleum . Fragrant and charming indoor plant producing numerous small dark lavender flowers with golden stamens. Foliage light green. Seedlings sown in Jan.-Feb. flower in June and continue until autumn50
2691	Golden Glory . Double golden yellow deepening to orange at the center20		FERNS . A well-known, graceful and attractive class of plants.	
			2740	Greenhouse Varieties, Finest Mixed25
			2745	Hardy Varieties, Mixed . Finest sorts for outdoor growing25

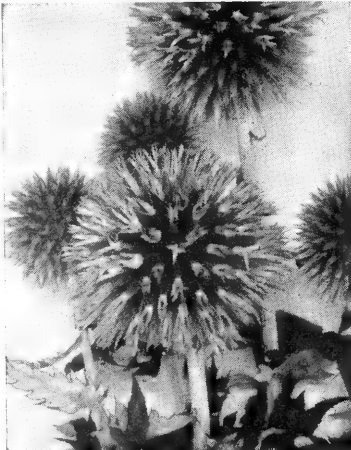

Echinops ritro



Erigeron



Eschscholtzia

No. Pkt.
 2765 **FUCHSIA, Double and Single Mixed.** The raising of Fuchsias from seed is interesting, there always being the possibility of securing something new and distinct; the seed offered is saved from a choice collection\$0.50

GAILLARDIA (Blanketflower). Beautifully showy annuals, giving a profusion of brilliant flowers during the summer and autumn. Fine for cutting. 3 ft.

2770 **Single, Finest Mixed.** All colors..Oz. 75c .10
 2775 **Double, Finest Mixed.**.....¼ oz. 50c .10
 2780 **Indian Chief, Single bronze-red.** ¼ oz. 50c .15

GAILLARDIA. Perennial varieties. 3 to 4 ft.

2783 **Burgundy.** Shining wine-red flowers, 2½ inches across. Plants bushy, 2½ ft.25
 2784 **GOBLIN.** Perennial Grandiflora. Dwarf variety, 12 to 15 inches high. Yellow with deep red border25
 2790 **maxima.** Large. pure yellow¼ oz. 50 .15
 2793 **Portola hybrida** (New). Bronzy red shades, golden tipped¼ oz. 50c .25
 2796 **Tangerine.** Orange-red25
 2797 **The Dazzler.** Red, tipped gold. ¼ oz. 35c .15
 2800 **Finest Hybrids**¼ oz. 50c .15

2820 **GENTIANA acaulis** (Alpine Blue Gentian). Dwarf early, spring-flowering Alpine perennial, with intense blue, bell-shaped flowers, 4 in.¼ oz. 85c .15

GERANIUM. Popular plants, easily raised from seed. Half hardy perennial.

2835 **Show Pelargoniums** (Lady Washington). Newest large-flowered Show varieties. .50
 2840 **zonale, Finest Mixed.** Specially saved.... .15
 2845 **Double, Finest Mixed.** Finest sorts..... .50

2855 **GERBERA jamesoni** (Transvaal Daisy). Beautiful Daisy of a brilliant orange-vermilion color, on long stems, blooming almost the whole year if given greenhouse protection during winter.. .50

2860 **jamesoni Hybrids.** New hybrids of the preceding which are more hardy and easily grown. The colors are rich and delicate, with a wonderful range from pure white through orange, salmon, rose, cerise, to ruby red and violet.... .50

2865 **GESNERIA, Mixed Hybrids.** Greenhouse bulbous plants with beautifully marked velvety foliage and handsome spikes of brilliantly colored flowers50

GEUM. Showy, hardy perennial of easy culture, and well adapted for the flower garden; fine for cutting. July to Oct. 3 ft.

2875 **coccineum.** Bright scarlet¼ oz. 30c .10
 2876 **Mrs. Bradshaw.** Double scarlet..... .25
 2877 **Lady Stratheden.** Beautiful orange..... .25
 2880 **GILIA, Finest Mixed.** Showy, hardy annual, blooming from early in the season until frost, 1 ft.¼ oz. 30c .10



Gaillardia

No. Pkt.
GLOBE-AMARANTH (Gomphrena). Showy annual everlasting; the flowers resemble clover heads, and when dried are used for winter decoration; fine for bedding. 1½ ft.
 2890 **Purple** ¼ oz. 25c \$0.10
 2895 **Orange** ¼ oz. 25c .10
 2898 **Rose** ¼ oz. 25c .10
 2900 **White** ¼ oz. 25c .10
 2905 **Mixed.** All colors¼ oz. 25c .10

GLOXINIA. The seed offered has been selected from the finest erect flowering varieties and will give blooms of finest quality. For a succession of flowers from seed, sowings should be made at intervals from January to May. A moist heat of from 65 to 70 degrees is best to start them in.

2910 **Grey's Invincible Prize.** Has the reputation of being the finest strain grown; very free flowering, with large open flower in the greatest variety of colors. 1.00

GORETTIA (Satin Flower). Handsome hardy annuals, blooming profusely from July to October. Large, wide open flowers of shining satiny texture, and of the most delicate and brilliant colors. 1½ ft.

2925 **Double Rosy Morn**¼ oz. 50c .10
 2932 **Kelvedon Glory.** Deep salmon-orange... .35
 2935 **Lady Satin Rose.** Rose-pink ..¼ oz. 50c .10
 2937 **Lavender.** True color ¼ oz. 50c .10
 2937B **Purity.** Extra large single, frilled, pure white; upright habit¼ oz. 50c .10
 2937C **Ruby.** Deep red. Very compact15
 2938 **Sweetheart.** New dwarf double. Bright cream-pink ¼ oz. 50c .10

No.		Pkt.	No.		Pkt.	
	GODETIA—Continued.			HELIANTHUS—Continued.		
2939	Sybil Sherwood. Bright salmon-pink.... ¼ oz. 50c	\$0.10	4000	Giant Russian. Large. 6 ft.	Oz. 20c \$0.10	
2940	Mixed. Tall, double. Beautiful colors... ¼ oz. 35c	.10	4002	Golden Fleece. Small Cactus flowers, golden yellow; dark center15	
	GOURDS, Ornamental. Quick growing vines desirable for covering arbors, walls, etc., and producing useful and ornamental fruit in great variety of shapes and colors. Tender annual. 15 to 20 ft.			4005	Maroon Prince. Deep crimson, shading lighter toward the points....	¼ oz. 50c .15
2945	Collection of 12 sorts	1.00	4010	Perennial Hybrids. The flowers vary in shades, size and form ..	¼ oz. \$1.00 .15	
2955	Apple Shape. Striped fruit	Oz. 40c .10		HELICHRYSUM, Double Flowered. Pretty annual everlasting, blooming all summer; fine in mixed borders and useful as dried flowers for winter, for which purpose they should be gathered before fully open, 2 ft.		
2960	Bottle Shape. White and green. Oz. 40c	.10	4015	Mixed	¼ oz. 35c .10	
2965	Dipper Shape	Oz. 40c .10	4016	Canary Yellow	¼ oz. 35c .15	
2970	Dishcloth or Sponge	Oz. 40c .10	4017	Deep Crimson	¼ oz. 35c .15	
2975	Egg Shape. Useful as nest eggs Oz. 40c	.10	4018	Salmon	¼ oz. 35c .15	
2980	Gooseberry. Very small	Oz. 60c .10	4019	Golden Ball	¼ oz. 35c .15	
2985	Hercules Club. 4 ft. long	Oz. 40c .10	4020	Rose Queen	¼ oz. 35c .15	
2990	Orange Shape. Mock orange	Oz. 40c .10	4021	Silver Pink	¼ oz. 35c .15	
2995	Fear Shape. Striped	Oz. 40c .10	4022	Violet	¼ oz. 35c .15	
2998	Pipe Gourd (Calabash)	Oz. 40c .10	4023	White	¼ oz. 35c .15	
3000	Serpent Shape. 4 to 5 ft. long....	Oz. 40c .10	4024	HELIOPHILA leptophylla. 9 in. Excellent annual for border. Flowers ½ in. across, bright blue with white eye.....	.25	
3008	Turk's Turban. Small, bright red. Oz. 40c	.10		HELIOTROPE. A universal favorite on account of its delicious fragrance; excellent for cutting. H. H. P.		
3010	Mixed Sorts. In great variety	Oz. 30c .10	4025	Grey's Giant Dwarf. Splendid strain of low, compact growth.....	¼ oz. 85c .25	
	GRASS, Ornamental. See page 40.		4030	Giant Hybrids. Mammoth	¼ oz. 85c .25	
6015	GREVILLEA robusta (Silk-oak). Beautiful evergreen, with fern-like foliage, magnificent for decorative purposes, and well adapted for house culture. Tender perennial....	¼ oz. 50c, oz. \$1.75 .15	4035	Mixed Dark Blue Shades	¼ oz. 50c .15	
	GYPHOPHILA (Babysbreath). Extremely light and graceful, hardy plants of easy growth, flowering from June to Sept. Useful for cutting to mix with other flowers.			HESPERIS matronalis (Sweet Rocket). Fragrant spring flowering hardy perennial, growing freely in ordinary soils.		
3020	elegans alba grandiflora. Large, white, annual	¼ oz. 15c, oz. 50c .10	4045	Dwarf Pure White. Early. 1 ft.,	¼ oz. 50c .15	
3022	elegans carminea.	¼ oz. 15c .10	4050	Pure White, 3 ft.	Oz. \$1.50 .10	
3025	elegans rosea. Rose-pink, annual. Oz. 50c	.10	4055	Purple, 3 ft.	Oz. 1.50 .10	
3028	pacifica. Hardy perennial. New pink, blooming after the paniculata variety.	.20	4060	Mixed. Purple and white	Oz. 1.00 .10	
3030	paniculata. Pure white, hardy....	¼ oz. 50c .10	4064	HEUCHEEA, Choice Hybrids. Dwarf hardy perennials. Spikes of numerous small bell-shaped flowers, well above the foliage. 1 ft25	
3035	f. pl. Double, white, hardy. This variety produces about 60 per cent of double flowering plants.25	4065	sanguinea splendens. Brilliant crimson.	.25	
	HELENIUM. A most valuable hardy perennial, fine for cutting, as it gives an enormous crop of flowers in the late summer and autumn. 5 ft.					
3045	autumnale superbum. Golden; fine25				
3050	bigelowi. Golden yellow, with black center15				
3054	Riverton Gem. Old gold changing to wallflower-red. 3 ft.25				
3055	HELIANTHEMUM mutabile. Dwarf hardy perennial, with brilliant flowers of various colors; very profuse in bloom and suited for dry soil and rockeries. June to Sept. 1 in.	¼ oz. 60c .15				
	HELIANTHUS (Sunflower). Well-known hardy annuals, the small flowering sorts being very useful for cutting, while the larger sorts are very ornamental and useful, blooming all summer.					
3060	Double Californian. Deep yellow. 5 ft.	Oz. 50c .10				
3065	Double Chrysanthemum flowered. Orange-yellow, fine for cutting. 5 ft....	Oz. 60c .10				
3070	Dwarf. Orange. 3 ft.	Oz. 50c .10				
3075	globosus fistulosus. Large, globe shaped, rich orange color. 7 ft.	Oz. 30c .10				
3080	Single cucumerifolius (Miniature Sunflower). Small, bright yellow, with black center. 4 ft.	Oz. 75c .10				
3090	cucumerifolius, Stella. Golden yellow. The largest miniature sort. 4 ft. ..	Oz. \$1.00 .10				



Helianthus, Chrysanthemum-Flowered

No.		Pkt.
	HIBISCUS. A showy class of plants suitable for mixed beds or borders, with large and beautifully colored flowers. Free flowering. Hardy perennials, unless noted.	
4070	Trionum. New. Large ivory flowers with maroon center, orange stamens. 2 ft. ¼ oz. 35c	\$0.10
4075	Crimson Eye. Large, pure white, crimson center, July to Sept. 4 ft. ¼ oz	50c .15
4078	Giant Bed. ¼ oz. 50c	.15
4080	moscheutos, Rose. Large, light rose. July to Oct. 4 ft. ¼ oz. 50c, oz. \$1.50	.15
4085	moscheutos, White. Large, pure white. July to Oct. 4 ft. ¼ oz. 50c, oz. \$1.50	.15
4087	moscheutos Hybrids. ¼ oz. 50c, oz. \$1.50	.15
	HOLLYHOCK. One of the oldest garden favorites and finest of our autumn flowers. Seed sown in February and potted on will bloom the same season, and July sown seed the next season. They require a well-drained, deep, rich soil. Hardy biennial.	
4095	Collection of 6 Double Varieties	1.00
5000	Double Superb Mixed. An improved strain ¼ oz. 75c, oz. \$2.75	.20
5002	Colorado Sunset. Copper to cream ¼ oz. 75c, oz. \$2.75	.20
5005	Crimson ¼ oz. 75c, oz. \$2.75	.20
5006	Exquisite. A large, double fringed Hollyhock in a variety of colors with margined and blotched petals	.25
5007	Imperator, Mixed. Flowers 5 or 6 in. across, fringed, with rosette centers.	.35
5007A	Lilac Beauty ¼ oz. 75c, oz. \$2.75	.20
5007B	Maroon ¼ oz. 75c, oz. \$2.75	.20
5008	Newport Pink ¼ oz. 75c, oz. \$2.75	.20
5010	Orange Prince	.25
5012	Purple ¼ oz. 75c, oz. \$2.75	.20
5015	Rose Pink ¼ oz. 75c, oz. \$2.75	.20
5020	Royal Scarlet ¼ oz. 75c, oz. \$2.75	.20
5025	Snow White ¼ oz. 75c, oz. \$2.75	.20

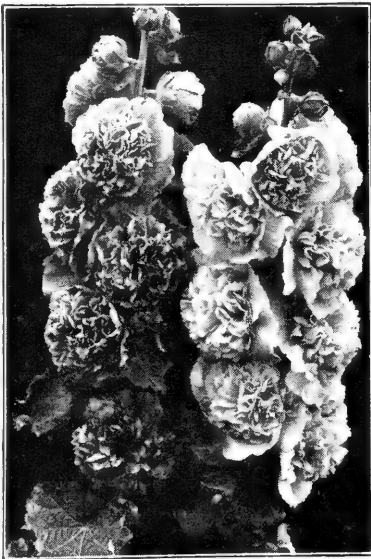

Double Hollyhocks

No.		Pkt.
	HOLLYHOCK—Continued	
5030	Yellow ¼ oz. 75c, oz. \$2.75	\$0.20
5035	Single Mixed ¼ oz. 50c	.15
	EVER-BLOOMING HYBRIDS (Annual). Beautiful flowers in all colors and shades, blooming the first season.	
5045	Double Mixed ¼ oz. 75c	.15
5046	Double Annual, Scarlet Beauty. Flowers in six months from seeds	.25
5047	Double Annual, Indian Spring. Bright rose and rosy carmine shades with attractive light fig-leaved foliage	.25
5050	Single Mixed ¼ oz. 60c	.15
5055	HONESTY, Mixed (Lunaria biennis). The seed pods, which are flat and broad, look like transparent silver and are much prized for winter decoration. 2 ft. ¼ oz. 50c	.10
	HUMULUS (Hop). Rapid growing climbers, with handsome foliage. 15 to 20 ft.	
5060	japonicus. Green foliage, H. A. ¼ oz. 30c	.10
5075	HUNNEMANNIA fumaræifolia (Giant Yellow Tulip Poppy). Perennial. Flowers throughout the season. Blooms in three months from seed. 2 ft. ¼ oz. 50c	.10
5078	Sunlite. Double perennial poppy with extra band of petals outside, giving the impression of an open flower at all times. Color, canary-yellow, foliage light gray-green. 2 ft.	.20
	IBERIS (Hardy Candytuft). Free flowering compact perennials, making a beautiful display early in the season; suitable for rockeries and borders. 1 ft.	
5080	gibraltarica. Very large flowers of a delicate lilac color ¼ oz. \$1.50	.15
5085	sempervirens. The evergreen Candytuft with glossy, deep green foliage and white flowers ¼ oz. \$1.75	.15
	Annual Varieties. See Candytuft.	
5090	ICE PLANT. Half-hardy annual with leaves and stems thickly covered with sparkling ice-like globules. Fine for vases and piazza boxes, also for garnishing. Flowers white, 6 in. ¼ oz. 25c	.10
	IMPATIENS. Tender perennial for pot culture in the house or greenhouse and very useful for summer bedding, as they are in bloom continually	
5095	holsti. Large, brilliant vermilion	.50
5100	holsti Hybrids. Large flowered sorts	.35
5105	sultani. Large, rich bright rose. 1 ft.	.25
5110	INCARVILLEA delavayi. Half hardy perennial, with large bright rose-colored, bell-shaped flowers in clusters	.25
	IONOPSIDIUM (Violet Cross). Sow inside in March or in a cold frame in April.	
5115	acaule. A charming miniature covered with white flowers marked with violet. Recommended for pot culture and for edging. 3 in.	.25
	IPOMOEA, Morning Glory. Splendid rapid growing climbers, with large, bright colored flowers. Hardy annual. 15 ft.	
5118	Alamo Vine or Mile-a-Minute Vine. Attractive, quick growing covering for fences or trellises, dainty lacy foliage, inconspicuous creamy white, red-throated flowers blooming a long time.	.15

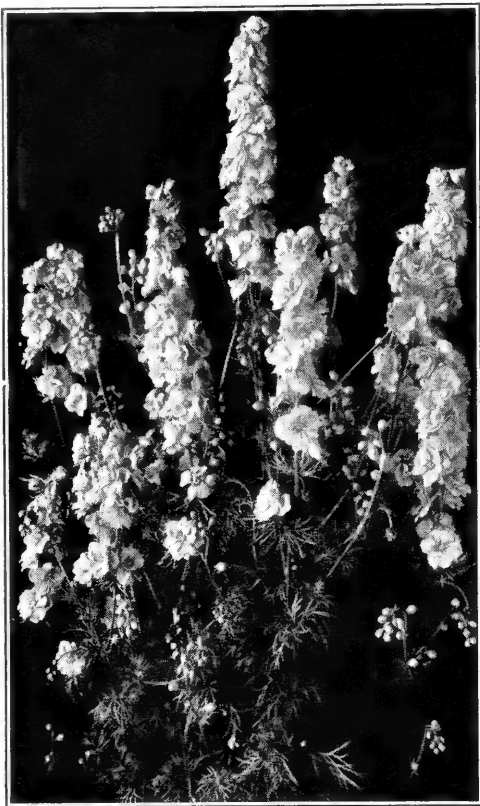

Larkspur, Giant Imperial

No.	IPOMOEA—Continued.	Pkt.
5119	Cornell. Large flowers of carnelian-red, bordered white	\$0.25
5120	purpurea, Finest Mixed (Morning Glory, Convolvulus major) . . . Oz. 25c, ¼ lb. 75c	.10
5135	Heavenly Blue. Early flowering. Immense beautiful flowers of bright sky-blue; seed should not be sown outside till ground is warm	¼ oz. 35c .15
5140	imperialis japonica (Japanese Giant). Most beautiful strain, with immense flowers of finest colors and markings.	Oz. 60c .10
5145	noctiflora hybrida (Moonflower). Large, fragrant, white flowers	Oz. \$1.00 .10
5146	Scarlett O'Hara. Flowers of rich dark wine-red or deep rosy crimson, about 4 inches across, freely produced on fast growing vines	¼ oz. 50c .20
	JACOBAEA. Beautiful free-flowering annuals producing fine heads of double flowers which are extremely valuable for cutting.	
5147	Tall Double Crimson	.25
5149	Tall Double Purple	.25
5150	Tall Double Rose	.25
5151	Tall Double White	.25
5152	Tall Double Mixed.	.25
5153	KALANCHOE globulifera coccinea. Excellent winter flowering house plant. Brilliant scarlet Bouvardia-like flowers and small green foliage	.50
5154	KOCHIA childsi (Mock Cypress, or Burning Bush). Compact bushes about 2½ ft. high, with small, feathery, light green foliage which changes to crimson in September	¼ oz. 25c .10

No.		Pkt.
5155	KUDZU VINE. Easily grown from seed. Attains a length of 40-50 ft. from established roots. Flowers purple, pea-shaped, and borne in clusters late in the season. Foliage large and lobed	\$.15
	LANTANA. Fine greenhouse plants or can be used for bedding out in summer; flowers are similar to verbenas, ranging in color from orange to rose. Profuse bloomer. Sow seed early in February or March indoors.	
5156	New Dwarf Bedding Hybrids, 1 ft.	.25
5157	Tall Hybrids, 2 ft.	¼ oz. 50c .15
	ANNUAL LARKSPUR. Seeds sown in the open ground before the close of April will produce flowering plants by the beginning of July, and give a continuous succession of flowers from then until frost. They make handsome beds and are very effective among shrubs.	
	COCKADE. A new type of compact and symmetrical habit of growth, throwing long spikes of very double, compact flowers with round petals.	
5158	Cinnabar. Rich brilliant rose-red.	¼ oz. 35c .20
5159	Rose	¼ oz. 35c .20
5160	Salmon Pink.	¼ oz. 35c .20
5161	Sapphire. Deep lilac	¼ oz. 35c .20
5162	Violet. Rich violet-purple	¼ oz. 35c .20
5163	White.	¼ oz. 35c .20
5164	Mixed	¼ oz. 35c .20
5165	Collection of 6 pkts.	1.00
	TALL BRANCHING STOCK FLOWERED.	
	3 ft.	
5166	Appleblossom Pink	¼ oz. 30c .10
5167	Dark Blue	¼ oz. 30c .10
5168	La France. Salmon-pink	¼ oz. 30c .10
5169	Light Blue	¼ oz. 30c .10
5170	Newport Scarlet	¼ oz. 30c .10
5171	Rosamond. Pure rose, fadeless.	¼ oz. 30c .10
5172	White	¼ oz. 30c .10
5173	Mixed	¼ oz. 30c .10
5174	Collection of 6 packets	.50
	GIANT IMPERIAL, 4 ft.	
5176	Blue Bell. Clear light blue	¼ oz. 30c .15
5177	Blue Spire. Deep blue	¼ oz. 30c .15
5178	Dazzler. Bright carmine	¼ oz. 30c .15
5179	Exquisite Soft Pink Imp.	¼ oz. 30c .15
5180	Exquisite Rose	¼ oz. 30c .15
5181	Gloria. Rich, deep rose	¼ oz. 30c .15
5182	Lilac Spire	¼ oz. 30c .15
5183	Los Angeles. Rose on salmon	¼ oz. 30c .15
5184	Pink King. New, soft salmon-rose.	¼ oz. 60c .25
5185	Pink Perfection. Light pink	¼ oz. 40c .20
5186	White King. Glistening white	¼ oz. 30c .15
5187	Mixed	¼ oz. 30c .15
5188	Collection of 8 packets	1.00
	LATHYRUS latifolius (Perennial Pea). Handsome, free-flowering, hardy perennial climber of great beauty, with clusters of elegant, Sweet Pea-like flowers in great profusion; useful as a cut flower. ■ ft.	
5195	albus. Pure white	¼ oz. 75c .15
5200	Pink Beauty. Bright rosy pink	¼ oz. 75c .15
5205	splendens. Rich crimson	¼ oz. 75c .15
5210	Mixed. All colors	¼ oz. 40c, oz. \$1.25 .10
	LAVATERA (Bar Harbor Marsh Mallow). Large flowered variety, hardy annual, allied to the Mallows, covered during the entire summer with its pretty and showy blossoms. 3 ft.	
5215	splendens. Rose	¼ oz. 50c .15
5218	splendens, Sunset. Rosy carmine	¼ oz. 50c .15
5220	splendens. White	¼ oz. 50c .15
5225	LAVANDULA vera (Sweet Lavender). Chiefly cultivated for the delicious and lasting fragrance of its flowers. Hardy perennial. July to September. 2 ft.	Oz. \$1.00 .15

No.		Pkt.
5229	LEPTOSYNE, Golden Rosette. Double bright butter-yellow flowers	\$0.25
5230	maritima. Large single yellow Coreopsis-like flowers on long stems; August to October. 2 feet.15
5232	Stillmani. A dwarf early flowering sort, fine for borders and for forcing in the greenhouse. 18 in.25
5234	LIATRIS pycnostachya. Purple, 4 ft. August to October. Hardy perennial.25
5235	spicata. (Blazing Star). Desirable hardy perennial. The brilliant rosy purple flowers are on long spikes and freely produced. July to September. 2 ft.15
5239	LILIUM PHILIPPINENSE, Formosanum Improved. Long white trumpet flowers, slightly marked externally reddish brown35
5240	LILIUM regale (Royal Lily)25
	LINARIA (Toadflax). Annual. 1 ft.	
5241	Fairy Bouquet. Dwarf, compact. Mixed ..	.25
5242	Fairy Bridesmaid. Bushy plants with blooms of a citron-yellow hue25
5243	maroccana, Excelsior Mixed15
5243A	maroccana. Snow white.15
5244	Canon J. Went. Pink perennial. 2 ft.25
5245	cymbalaria (Kenilworth Ivy). Beautiful, trailing plants for baskets15
	LINUM. A valuable class of plants flowering for months and worthy of extended cultivation in masses or clumps in mixed borders. 1½ ft.	
5250	grandiflorum rubrum. Brilliant scarlet, annual10
5254	perenne, Blue (Perennial Flax).15
	LOBELIA. Most useful plants, free flowering and of easy culture. For bedding, edging, vases, etc. Treated as annuals, except the Cardinal varieties.	
5260	cardinalis. Brilliant scarlet; hardy. 3 ft.25
5265	grandiflora. Flowers double the size of the old sorts; hardy. 1 ft.25
5266	Blue Stone Erinus. Compact, clear blue without eye, best for bedding.25
5267	Blue Wings. Dwarf blue variety25
5268	Cambridge Blue. Light blue, large flowered, green foliage, compact25
5270	Crystal Palace compacta. Extra select dark blue; fine edgings. ¼ oz. \$1.00 ..	.15
5275	gracilis. Spreading habit, with bright blue flowers	¼ oz. 75c .15

No.		Pkt.
	LOBELIA—Continued	
5280	hybrida, Sapphire. Deep sapphire-blue, white eye. Fine for hanging baskets.	\$0.25
5285	speciosa (Crystal Palace). Spreading habit, with dark blue flowers ¼ oz. 85c ..	.15
5290	White Lady. Compact, large flowered, pure white	¼ oz. 60c .10
5295	ramosa (Erect growing). Rich blue, large flowered. 9 in.	¾ oz. 50c .25
	LUPINUS (Lupines). Old-fashioned and well-known annuals, very free growing, with long spikes of bright colored, pea-shaped flowers, and useful in a cut state. 2½ to 3 ft.	
	New Giant King. The plants attain a height of 3 to 4 feet. They are base branching, each plant sending out from 6 to 8 enormous flower spikes. The beauty is enhanced by a narrow white stripe in the center of the standard. Blooms in 75 to 90 days from sowing and enjoys a long flowering season. Annual.	
	Heliotrope15
5300	Oxford Deep Blue15
5310	Pure White15
5315	Sky Blue15
	Collection, 4 Colors50
5318	Attraction. Sweet scented, soft rose-pink center golden. 3 to 4 ft.25
5325	Hartwegi albus. White	Oz. 50c .10
5330	Cambridge Blue. Sky-blue	Oz. 50c .10
5335	Oxford Blue. Rich dark blue ..	Oz. 50c .10
5340	roseus. Fine rose-pink	Oz. 50c .10
5342	Large Yellow. 1 ft.	¼ oz. 50c .20
5345	mutabilis. White, sweet scented. Oz. 50c ..	.10
5352	Texas Blue Bonnet. 1 ft.	Oz. 50c .10
5355	Mixed Annual Sorts. All colors. Oz. 50c ..	.10
	LUPINUS (Lupines). Perennial Varieties. Immense spikes of pea-shaped flowers. 3 ft.	
5358	Russell Strain. Re-selected stock of this world famous strain. In original sealed pkts. 20 seeds, 25c; 65 seeds, 65c; 150 seeds, \$1.25; 350 seeds, \$2.50.	
5360	polyphyllus, Blue	Oz. 75c .10
5362	Elliott's Sweet Scented. Mixed colors ..	.20
5363	Lavender Queen15
5364	luteus. Yellow.20
5365	moerheimi. Rose and white ..	Oz. \$2.50 .25
5370	roseus. Pink shades	Oz. \$1.50 .15
5375	White	Oz. 75c .10
5380	Mixed	Oz. 75c .10
5385	Excelsior Mixed. New shades ..	Oz. \$1.25 .15



Lobelia, Crystal Palace



Linum Perenne

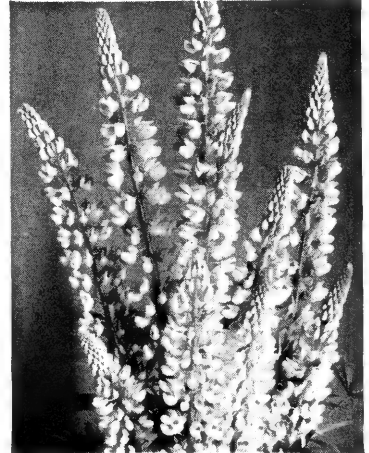

Lupinus—Lupines

No.		Pkt.
	LYCHNIS. Hardy perennials with large terminal trusses of very showy flowers.	
5390	<i>chalcedonica.</i> Scarlet. 3 ft. ¼ oz. 50c	\$0.10
5395	<i>alba.</i> White. 3 ft. ¼ oz. 50c	.10
5400	<i>viscaria splendens.</i> Deep red. 1½ in.10
5405	<i>haageana hybrida.</i> 18 in. ¼ oz. 85c	.15
5410	LYTHRUM roseum superbum. Vigorous perennial with spikes of bright rose colored flowers. 3 ft.15
	MALVA or MALLOW. Free flowering, hardy perennials. Sown early, will bloom first season.	
5430	<i>moschata</i> (Muskmallow). Clusters of fragrant rose-colored flowers .. ¼ oz. 50c	.15
5435	<i>alba.</i> White, fragrant. 2½ ft. .. ¼ oz. 50c	.15
	MARIGOLD, Double African. Handsome hardy annuals, with rich and showy flowers throughout the season. 3 ft.	
5436	All Double Lemon ¼ oz. 40c	.10
5438	All Double Orange ¼ oz. 40c	.10
5439	Collarette, Crown of Gold. 2½-inch orange flowers, crested center surrounded by broad guard petals. Odorless foliage ..	.15
5445	Grey's Selected Orange Prince25	
5450	Grey's Selected Lemon Queen25	
5451	El Dorado Mixture ¼ oz. 40c	.10
5452	Dwarf Double African Queen Mixed15
5453	Chrysanthemum Flowered California Giants Mixed. Enormous flowering type, plants 4-5 feet high15
5454	Gigantea Sunset Giants. Flowers have a definitely sweet fragrance, and are loosely formed and very large, 5 to 7 inches across. Color ranges from deep orange to light primrose20
	Carnation Flowered Type.	
5455	Golden Eagle. Early flowering, same habit and form as Guinea Gold, but the color is a luminous gold15
5458	Golden West. Carnation flowered orange, 2½ ft. ¼ oz. 35c	.10
5459	Guinea Gold. Flowers loosely double, orange flushed with gold. A fine cut flower variety ¼ oz. 35c	.10
5465	Spanish Gold. Hedge or border type. A row appears as a well trimmed hedge 20 in. high, 30 in. wide, sides symmetrical, with a flat top. Flowers golden orange15
5470	Extra Early, Dwarf Hybrids. Color ranges from bright orange to clear lemon; 18 inches with many base branches and laterals, producing a mass of color completely smothering the foliage15
5474	Yellow Supreme. Re-selected strain. Large, fluffy blooms of creamy lemon-yellow; free from the Marigold odor. ¼ oz. 35c	.15
5476	American Beauty Golden. Orange20
5482	Tom Thumb. Golden crown.20
	MARIGOLD, French, Double. These are the small velvety flowered sorts. 1 ft.	
5485	Collection of 11 varieties, separate50
5486	Dark Brown ¼ oz. 40c	.10
5488	Dark Maroon. (Robert Beist) ¼ oz. 40c	.10
5490	Gold Striped. ¼ oz. 40c	.10
5491	Golden Ball ¼ oz. 40c	.10
5492	Harmony. Tubular deep orange centers flanked by broad velvety maroon-brown guard petals. Early ¼ oz. 40c	.15



Marigold, Yellow Supreme

No.	MARIGOLD—Continued	Pkt.
5493	Golden Harmony. Dwarf, compact Scabious type. Guard petals and center bright golden yellow ¼ oz. 50c	\$0.15
5493A	Lemon Ball ¼ oz. 40c	.10
5495	Fulchra, Spotted ¼ oz. 40c	.10
5496	Orbit. Dwarf French Scabious type. Free flowering compact little plants; deep golden yellow, quilled centers, reddish brown guard petals15
5500	Dwarf Double French Monarch Strain Mixed. Very compact, large tight double flowers ¼ oz. 40c	.10
5503	Dwarf Royal Scot All Double. Rich mahogany and gold in uniform stripes. Plants are dwarf, bushy ¼ oz. 40c	.10
5504	Tall French, Double Royal Scot. 2-2½ ft. Mahogany and gold stripes15
5510	Tall Double Mixed. 2½ ft. ¼ oz. 50c	.10
5511	Tall Double French Winter Harmony. A new type for winter flowering in the greenhouse. It is of the quilled Scabious type with a single row of reddish brown guard petals encircling a golden orange quilled center, with mahogany dots on the tips of the quilled petals. Uniform growth of 3 feet with 100% double 2-inch flowers25
5512	Tall Single French Josephine. 3 ft. Brown with fine gold edge10
5513	Lieb's Winter Flowering. Fine to follow Chrysanthemums in the greenhouse. Flowers about 3 inches across, deep mahogany-brown with golden yellow crest25
5514	Dwarf Single French, Fire Cross. Saffron-orange with brown-red center10
5515	Legion of Honor (Little Brownie). Single golden yellow, with a large spot of crimson velvet. 1 ft. ¼ oz. 30c	.10
5516	Tagetes Signata Pumila, Golden Ring.	.10
5518	Tagetes Signata Pumila, Little Giant. Very deep orange, free flowering; compact habit. 6 inches15
5520	signata pumila (Tagetes). Single orange-yellow. 1 ft. ¼ oz. 50c	.10
5522	Star of India. Single crimson striped yellow ¼ oz. 60c	.15

No.		Pkt.
5525	MATTHIOLA bicornis (Night-scented Stock). Delightfully fragrant towards evening. Hardy annual, with purplish red flowers. 1 ft. ¼ oz. 50c \$0.10	
	MATRICARIA (Feverfew). Free flowering annuals, useful for groups, borders and pot culture; also fine for cut flowers.	
5528	capensis alba plenissima . 2 ft.. ¼ oz. 50c .15	
5530	Dwarf Double Snowball ½ oz. 40c .15	
5535	Dwarf Double Golden Ball . Quilled petals. ½ oz. 40c .15	
5541	MAURANDIA, barclayana . Blue25	
	MESEMBRYANTHEMUM . Dwarf growing annuals of great beauty; excellent for rockeries, edgings, vases, etc. ¼ in.	
5545	tricolor Mixed ¼ oz. 50c .15	
5550	cordifolium variegatum . Handsome foliage and bright rose colored flowers. . . .25	
	MIGNONETTE (Reseda). The most popular and favorite annual for garden and house culture, producing quantities of deliciously fragrant spikes of flowers.	
5555	Improved Eclipse . The immense, fragrant spikes of flowers 10 to 15 in. long, are produced in the greatest profusion. A superior variety for winter blooming, exhibition or cutting ½ oz. 60c .25	
5560	Defiance . Very fragrant, large spikes, with individual florets of immense size..... ¼ oz. 40c, oz. \$1.25 .10	
5565	Giant Pyramidal . Large, fragrant spikes of reddish flowers .. ¼ oz. 25c, oz. 75c .10	
5570	Machet Improved . Dense spikes of very fragrant, dark red flowers; fine for pot culture ¼ oz. 50c; oz. \$1.50 .15	
5575	Machet, Golden . Long, massive spikes with fragrant, golden yellow flowers .. ¼ oz. 25c, oz. 75c .10	
5578	Orange Queen ¼ oz. 25c .10	
5580	Machet, White Pearl . Long spikes of fragrant white flowers ¼ oz. 50c .10	
5590	odorata . The old-fashioned common sweet-scented sort..Oz. 35c, ¼ lb. \$1.00 .10	
5595	MIMOSA pudica (Sensitive plant). A tender annual of light and elegant growth, the leaflets of which fold up when touched; the pale, purplish flowers are produced at the axils of the leaves. 2 ft. ¼ oz. 50c .15	
5610	MIMULUS moschatus (Musk). Well known popular plant, with fragrant, yellow flowers and foliage ½ oz. 85c .25	
	MIRABILIS (Marvel of Peru, or Four-o'clock) Well known annuals, with most brilliant flowers of various colors, suitable for beds or borders. ¼ ft.	
5620	Mixed. Brilliant colorsOz. 35c .10	
5625	Variegated Foliage, Mixed . All colors, with green and white leaves...Oz. 35c .10	



Myosotis (Forget-Me-Not)

No.		Pkt.
	MYOSOTIS (Forget-me-not). These beautiful half-hardy perennials bloom the first season and succeed best in moist, shady situations. If sown in frames in July or August, fine plants may be had for spring blooming. Fine for edging or in beds with Pansies, Daisies, etc.	
5645	Alpestris robusta grandiflora . Large, bright blue clusters. 1 ft. .. ¼ oz. \$1.00 \$0.15	
5646	Blue Ball . Re-selected globular form, compact, dark blue35	
5648	Blue Bird . Large deep blue for winter flowering25	
5650	Indigo or Royal Blue . Rich.. ¼ oz. \$2.00 .25	
5653	Indigo compacta . Very dwarf..... ¼ oz. \$2.50 .25	
5655	Victoria . Rich, bright blue, of dwarf, globular habit ¼ oz. \$2.50 .20	
5660	Victoria rosea . Fine pink .. ¼ oz. \$2.50 .20	
5670	dissitiflora Perfection . Bright blue flowers on long stalks last a long time, and are most suitable for table decoration at Christmas. Sow in June for winter blooming. 1 ft. ¼ oz. \$2.00 .25	
5675	Palustris semperflorens (True Water Forget-me-not). Large, azure blue flowers. Blooms all summer ¼ oz. \$2.50 .25	
5680	Ruth Fischer . Azure blue. The largest flowered variety25	
5685	Stricta grandiflora . Upright, pillar-like habit; bright blue; very striking..... ¼ oz. \$1.50 .15	
5690	Special Mixture . All colors... ¼ oz. \$1.00 .15	

Nasturtiums

A MARVELOUS RANGE OF NEW COLORS HAS BEEN DEVELOPED IN THESE FAVORITE FLOWERS

No.		Pkt.
	NOVELTIES FOR 1941	
5818	NASTURTIIUM, Double Sweet Scented Tall Glow. A new group of doubles which throw short runners and are taller than the dwarf, compact varieties. In the following colors:	
	A—Amber	D—Rose
	B—Crimson	E—Salmon
	C—Golden Orange	F—Vermilion
	Each	Oz. 40c \$0.15
	Collection 6 Colors75

	DWARF EMPEROR DOUBLE. The Emperor strain is dark leafed and compact.	
5796	Scarlet Emperor	Oz. 50c .15
5797	Sun Emperor	Oz. 50c .15
5798	Art Shades. Pastels	Oz. 50c .15

	NASTURTIIUM, Dwarf, or Tom Thumb Single Varieties. They succeed best and flower better in poor soil and remain longer in bloom than perhaps any other annual. 1 ft.	
	Oz. 20c, ¼ lb. 50c, lb. \$2.00	
5695	Collection of 8 Colors75
5700	Columbia Mixture. Our own mixture from separate and distinct sorts10
5740	Empress of India. Crimson10
5745	Golden King. Rich, golden yellow10
5750	King Theodore. Maroon, dark foliage10
5755	King of Tom Thumb. Scarlet10
5760	Lady Bird. Yellow, barred with ruby10
5765	Pearl. Pearly white10
5775	Rose. Soft carmine-rose10
5795	Vesuvius. Salmon-pink, dark foliage10

SEMI-DOUBLE NASTURTIIUMS SWEET SCENTED		
5800	Dwarf Gem Mixture. Compact form without runners.	Oz. 30c .10
5802	Dwarf Golden Globe	Oz. 30c .10
5804	Dwarf Mahogany Gem	Oz. 30c .10
5806	Dwarf Orange Gem	Oz. 30c .10
5808	Dwarf Salmon Gem	Oz. 30c .10
5810	Dwarf Scarlet Gem	Oz. 30c .10
5811	Gleam Hybrids. Gorgeously colored, large, well-formed	Oz. 25c .10
5812	Golden Gleam. Vines semi-trailing, about 2 ft.	Oz. 30c .10
5812A	Mahogany. Deep mahogany-red ..	Oz. 30c .10
5812B	Moon Gleam. Light golden cream	Oz. 30c .10
5813	Orange Gleam. Deep glowing golden orange	Oz. 30c .10
5813A	Primrose Gleam. Lemon	Oz. 30c .10
5814	Scarlet Gleam. Immense blooms of fiery orange-scarlet, fragrant	Oz. 30c .10
5815	Salmon Gleam	Oz. 30c .10
5815A	Supreme. Salmon-cerise	Oz. 30c .10
5816	Indian Chief Gleam. Scarlet, dark foliage	Oz. 30c .15
5817	Indian Summer Gleam. Orange-buff, dark foliage	Oz. 30c .15



Nasturtium, Double Gleam Type

No.		Pkt.
	SINGLE NASTURTIIUM, Tall or Running Varieties. Large, free flowering climbers for verandas, trellises and covering unsightly places.	
5819	Collection of 8 Colors	\$0.75
5820	Columbia Mixture. Our own mixture, which we make up from separate and distinct sorts, is without an equal.....	.10
5825	Bright Rose10
5835	Coccineum. Bright scarlet10
5840	Dark Crimson10
5858	Gold Garnet. Orange, spotted garnet....	.10
5865	King Theodore. Very deep maroon.....	.10
5880	Pearl. Almost white.....	.10
5895	Sunlight. Giant, rich golden.....	.10
5905	Vesuvius. Rich apricot, dark foliage10
	NASTURTIIUM, lobbianum. Free flowering, rich and bright in color, and with dark foliage.	
5990	Mixed. All colors	Oz. 20c, ¼ lb. 60c .10

No.		Pkt.
6000	NEMESIA strumosa suttoni, Improved Mixed. A valuable long-blooming annual	\$0.25
6001	Blue Gem, strumosa nana compacta. 8 in.25
6002	Fire King, strumosa nana compacta. 8 in.25
6003	Orange Prince, strumosa nana compacta. 8 in.25
6003A	Rose, strumosa grandif. suttoni25
6004	White Gem, strumosa nana compacta. 8 in.25
6004A	Dwarf Compact Hybrids. Special selection of improved habit. Very free-flowering. Mixed. 9 inches25
NEMOPHILA. Splendid, showy hardy annual for beds or edgings; beautiful decorative plants in pots for spring flowering in house or conservatory. 1 ft.		
6005	insignis. Bright blue, white center10
	¼ oz. 20c	
6010	Mixed. All shades10
	¼ oz. 20c	
NICOTIANA. Very effective annuals; in bloom throughout the season, and produce their fragrant, tubular-shaped flowers in great profusion; excellent for cutting.		
6015	affinis. White; fragrant; 3 ft. ..	.10
	¼ oz. 35c	
6020	Choice Hybrids. A great variety of bright colors; fragrant.....	.10
	¼ oz. 60c	
6022	Crimson Bedder. Dwarf, pyramidal rich deep crimson. 15 in.25
6028	hybrida, Pink Shades10
	¼ oz. 40c	
6030	sanderæ, Crimson King10
	¼ oz. 50c	
6032	suaveolens. Small flowered species, pure white, delightfully scented. 1½ ft ..	.25
NIEREMBERGIA. Graceful, half-hardy perennials of slender growth, blooming profusely the whole summer; fine for vases, baskets, etc.		
6040	frutescens. White and blue15
6045	gracilis. White and purple15
6048	Hippomanica. New. Lavender-blue flowers on dwarf compact plants having attractive light gray-green foliage35
NIGELLA (Love-in-a-mist). Interesting and free flowering, half-hardy annuals, with elegant cut foliage and curious flowers, of easy culture. 1½ ft.		
6050	Miss Jekyll. Beautiful long-stemmed variety, bright Cornflower-blue.10
	¼ oz. 35c	
6052	Miss Jekyll. White15
	¼ oz. 50c	
6055	Mixed. Shades of blue and white.10
	Oz. 35c	
OENOTHERA (Evening Primrose). A magnificent class of hardy plants, with large showy blossoms, preferring a light, sandy soil, and warm, sunny situations; July to October. 2 to 3 ft.		
6070	lamarckiana. 3 ft. Enormous yellow flowers from July to October.10
6072	missouriensis. 10 in. June to August. A low prostrate growing variety with ascending branches. Flowers very large soft yellow.25
6073	odorata. Yellow, fragrant10
	¼ oz. 40c	
6075	speciosa rosea. Fine rose color ¼ oz. 75c	.25

No.		Pkt.
PANSY. For early spring blooming the seed should be sown in July or August and the plants protected during winter. Early spring sown seed will give fine blooms during summer and fall. A good, cool, rich soil is essential. Rotted cow manure is the best fertilizer, and one cannot use too much. No fertilizer of a heating nature should be used; give plenty of water through dry weather.		
6095	Grey's Prize Exhibition Strain. This splendid mixture represents the highest perfection of large flowering, new high colored sorts; their brilliancy and richness are most striking	\$0.50
	¼ oz. \$2.50, ¼ oz. \$4.00	
6105	America. A very selected dwarf and free flowering sort. Comes in a fine mixture of popular light shades35
	¼ oz. \$1.50	
6118	Engelmann's Giant Mixed. A special English strain of dwarf compact habit. The flowers are huge and blooms early50
6125	Giant Trimardeau Mixed. Very showy.15
	¼ oz. \$1.50	
6130	Maple Leaf Super Giants Mixed. New, compact habit with large, attractive foliage. Bright colored flowers averaging 4 inches across50
	¼ oz. \$2.25	
6135	Masterpiece. Frilled edge, giant flowers of the richest colors25
	¼ oz. \$3.00	
6140	Matchless. English exhibition strain of immense size, in a variety of exquisite shades50
	¼ oz. \$3.00	
6141	Piper's Climbing Mixed. For greenhouse. Giant flowers in a good color range. Long, stiff stems	1.50
6142	Steele's Jumbo Mixed. Gigantic flowers in a wide range of bright colors. Earliest of all50
	1/16 oz. \$2.00	
6147	Swiss Giants, Mixed Colors. Enormous size, very long stems; flowers 3- to 5-blotched25
	¼ oz. \$2.00	
6150	Swiss Dwarf Giants. Rich and various shades of mammoth flowers on dwarf plants35

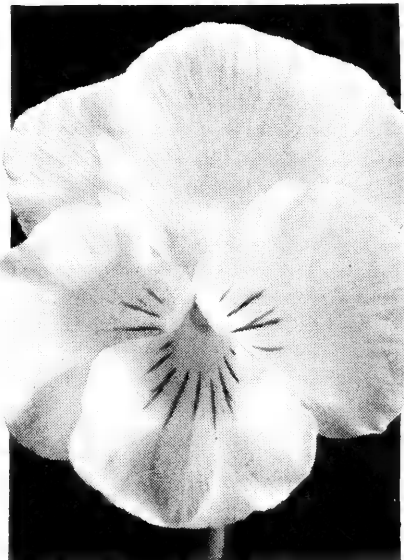

Giant Pansy

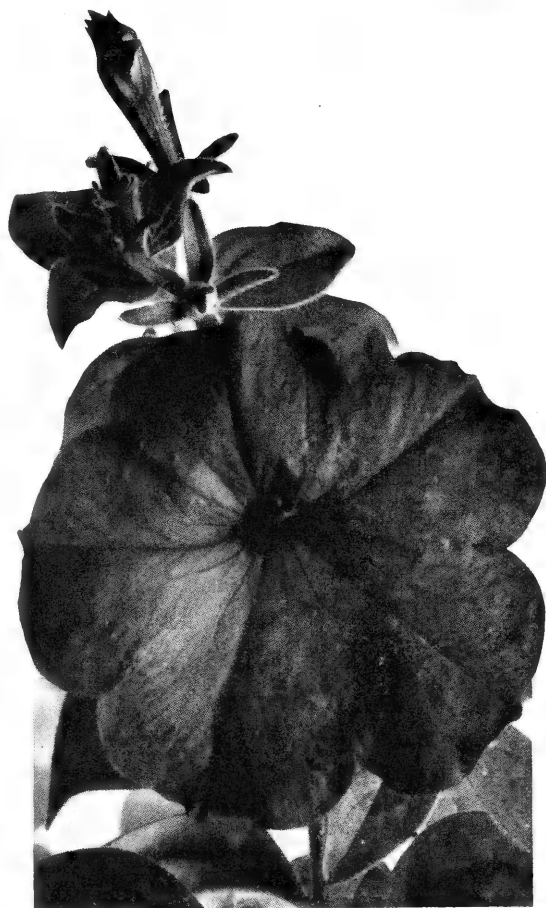

Petunia, Glow

PANSY—Continued.

No.		Pkt.
	SWISS GIANTS IN SEPARATE COLORS.	
	The plants are very robust, and the very large flowers of heavy texture are carried on strong stems well above the leaves.	
6162	Alpenglow. Rich deep Indian red and cardinal shades	\$0.25
6163	Berna. Dark velvety violet-blue25
6170	Golden Blotched. (Rhinegold) Canary-yellow with dark blotches25
6175	Pure Yellow Swiss. Clear golden yellow25
6180	Silver Bride. White25
6185	Ullswater Blue (Lake of Thun). The deepest of all blue Pansies, black-blue center25
6200	Collection of Six Colors.	1.25
	Each of above varieties, 1/8 oz. \$1.50.	
	MASTODON PANSY. These jumbo Pansies have a wide range of vivid colors and are early blooming.	
6210	Adonis. Ruffled type. Light blue and lavender shades35
6215	All White. Largest clear white variety ..	.35
6216	Aurora Giant. Rose and red shades35

No.		Pkt.
6220	Black Mastodon. Nearly all jet-black	\$0.35
6230	Coronation Gold. Tawny golden yellow ..	.35
6235	Elk's Purple. Immense blooms35
6240	Golden Gate. Golden yellow, dark center. .35	
6245	Isabelle. A ruffled bronze and gold35
6250	Mme. Irene. A henna-red type35
6260	Collection 7 Varieties.	2.00

PENTSTEMON. Treat as an annual. Attractive hardy perennial producing sprays of brightly colored tubular flowers. 2 to 3 ft.

6265	Giant-flowering Hybrids. Superb strain, large-flowered sorts; many new and rich colors	1/16 oz. \$1.00 .25
6270	Blue Gem. Extra deep blue25
6280	Gentianoides. Pure white flowers25
6285	Spectabilis coronaria. 2 1/2 ft. Bright, glowing red25

PETUNIA. An exceedingly attractive and favorite hardy annual for both indoor and outdoor cultivation; when not in too rich soil they will flower profusely through the summer.

MINIATURE OR GEM.

6288	Rose Gem. Compact, covered with rich rose-colored blooms25
6290	Pink and White Gem.25
6292	Violet Gem. New25
6293	White Gem.25
6294	Miniature Mixed25

BALCONY (HYBRIDA PENDULA)

6295	Balcony, Black Prince20
6296	Balcony Blue20
6297	Balcony Crimson20
6298	Balcony Rose20
6299	Balcony White20
6300	Balcony Mixed20

PETUNIA HYBRIDA NANA COMPACTA

6300A	Betsy Ross. Ruffled red and white, 2 1/2 in. blooms, deep red open throat25
6301	Celestial Rose Re-selected. Compact deep rose	1/8 oz. 75c .20
6301A	Cream Star. Cream, deepening in throat to golden; blooms star shaped25
6302A	Glow. Bright rose-red.25
6303	Heavenly Blue. Silver-blue re-selected ..	1/8 oz. \$1.50 .25
6303A	Lady Bird. Velvety scarlet, dark throat ..	.25
6304	Martha Washington. Blush-pink veined wine-red. Ruffled edge25
6305	Periwinkle. Pastel blue	1/8 oz. 75c .15
6305A	Rose of Heaven. Select strain rose-pink	1/8 oz. 75c .15
6305B	Rosy Morn Improved. Rose-pink, white throat	1/8 oz. \$1.00 .15
6306	Salmon Supreme. Clear salmon-pink25
6307	Scarlet Flare. New scarlet-rose25
6310	Snowball. Compact pure white. 1/8 oz. 60c	.15
6310A	Twinkles. Brilliant rose, starred white.	1/8 oz. 75c .15
6311A	Violet Blue. Rich velvety shade15
6312	Nana compacta Mixed.	1/8 oz. 60c .15

No.	PETUNIAS—Continued.	Pkt.
HYBRIDA, SINGLE BEDDING VARIETIES		
6314	General Dodds. Velvety blood-red, 1/8 oz. 75c	\$0.15
6315	Howard's Star Improved. Velvety purple, white star	.15
6316	Hollywood Star. Rich rose with amber throat; blooms shaped like five-pointed stars	.25
6320	Striped and Blotched 1/8 oz. 30c	.10
6326	Topaz Rose. Fiery velvety rose 1/8 oz. \$1.00	.25
6330	White King. Pure white, excellent	.10
6340	Splendid Mixture 1/8 oz. 30c; oz. \$2.00	.10

CALIFORNIA SINGLE GIANTS AND LARGE FLOWERING SINGLE TYPE.
The immense flowers are beautifully waved and ruffled, and the colors are exquisite.

6342	Burgundy. Deep red, white throat, plain edge	.35
6343	Dainty Lady. Delicate yellow fringed	.35
6344	Dwarf Elk's Pride. Dark velvety purple	.50
6345	Elk's Pride. Plain edge, deep purple	.25
6350	Fringed Perfection Mixed	.25
6352	Fringed Violet Hybrida.	.25
6353	Giant Pink Glory. Deep rose, plain edge	.35
6354	Lace Veil. Large flowered dwarf fringed white	.50
6356	Theodosia. Fringed rosy pink, golden center	.35
6357	Violet Blue. Deep velvety violet, giant, plain edge	.50
6358	White Beauty. Ruffled, fringed, snow white	.25
6359	White Cloud. Compact pure white. 12 in.	.25
6360	California Ruffled Monsters. Exquisite mixed	.50
6362	Dwarf Giant of California, Ramona Strain Mixed. Ruffled and fringed	.50

Double Large-Flowering Sorts

Seed of highly bred double Petunia is not as vigorous in growth as is that of single strains. To some extent this lack of vigor extends to the seeds. Seeds of our double strains are obtained from a reliable source and if carefully handled should give good results.

ALL-DOUBLE VICTORIOUS DWARF GIANT. This is an exceptionally fine strain of fancy double frilled giant flowers, many 5 inches across. They are beautifully frilled and ruffled and have a wide color range of exquisite shades. Plants are dwarf growing.

	Pkt.
6368A Apple Blossom	\$1.00
6368B Loveliness. La-France-rose	1.00
6368C Orchid Beauty	1.00
6368D White	1.00
6368E World Beauty. Rose-carmine	1.00
6368 "Victorious." Mixed colors	1.00

PETUNIA, DOUBLE GIANT RUFFLED AND FRINGED.

6370	Grey's Select Mixture. Double flowers; very large, full and beautifully formed	.50
6370A	Crimson.	.50
6370B	Copper Red.	.50
6371	Heliotrope.	.50
6372	Rose-Pink and White.	.50
6373	Rose Queen.	.50
6373A	Salmon-Pink	.50
6374	White Madonna. Deeply fluted	.50
6375	grandiflora, Mixed. Choice strain	.25

6380 **PHACELIA campanularia.** Beautiful annual with rich, deep blue, bell-shaped flowers 1/4 oz. 35c .10

No.	Pkt.
PHLOX DRUMMONDI. These beautiful hardy annuals continue in bloom the whole of the summer, and for bedding or massing nothing can surpass them for brilliancy and richness of color or profusion of flowers. 1 to 1 1/2 ft.	
6385	grandiflora collection of 4 colors, separate \$0.50
6390	Finest Mixed 1/4 oz. 85c .10
6395	Brilliant Scarlet 1/4 oz. 85c .10
6400	Crimson. White star center 1/4 oz. 85c .10
6410	Rose Pink. Fine shade 1/4 oz. 85c .10
6415	Pure White 1/4 oz. 85c .10
6417	Salmon Pink 1/4 oz. 85c .10
6418	Violet. White eye 1/4 oz. 85c .10
6420	Yellow 1/4 oz. 85c .10
6425	cuspidata, Finest Mixed. Beautiful star-shaped flowers 1/4 oz. 75c .10
6428	Gigantea Art Shades. Flowers an inch and a quarter in diameter. It has a most wonderful range of color 1/8 oz. \$1.00 .25
6429	Gigantea Salmon Glory. Pure salmon-pink with creamy white eye .20
6430	Dwarf, Extra Mixed. Compact strain for pot culture or edgings. Finest colors. 6 in. 1/8 oz. \$1.00 .25
6433	Apricot 1/8 oz. \$1.25 .25
6435	Bright Scarlet 1/8 oz. \$1.25 .25
6438	Coerulea stellata. Mauve 1/8 oz. \$1.25 .25
6440	Daybreak Pink 1/8 oz. \$1.25 .25
6445	Pure White 1/8 oz. \$1.25 .25
6446	Yellow 1/8 oz. \$1.25 .25
6450	Collection. 6 dwarf varieties, \$1.25.

6465 **PHYSALIS francheti** (Japanese Winter-cherry). Hardy perennial, treated as an annual. Edible fruit in large brilliant red capsules, which retain their color for months; fine for winter decoration. Two feet 1/4 oz. 75c .15

6470 **PHYSOSTEGIA virginica** (Texas Heath). Fine hardy perennial, resembling a giant heather with beautiful pink flowers. 15

6475 **virginica alba.** Large white 1/4 oz. \$1.00 .25

6480 **PLATYCODON grandiflorum** (Balloon Flower). Handsome hardy perennial, with large, deep blue, bell-shaped flowers, from June to October 1/4 oz. \$1.00 .15

6485 **grandiflorum album.** 1/4 oz. \$1.00 .15

6490 **mariesi.** Dwarf, rich blue 1/4 oz. \$1.00 .25

6495 **POLEMONIUM caeruleum, blue** (Jacobsladder). Hardy perennials with large heads of showy flowers. May to August. 2 ft. 1/4 oz. \$1.00 .15



Phlox Drummondii

No.		Pkt.	No.		Pkt.
	POPPIES, Single Shirley Varieties. For hardiness and easy culture these showy plants cannot be surpassed. They are very free flowering and make a gorgeous display.			POPPIES, Shirley Double Begonia-Flowered.	
6505	Danebrog. Single scarlet, with white blotch on each petal Oz. 75c	\$0.10	6592	Cavalcade. New double Begonia-flowered. Orange-scarlet ¼ oz. 40c	\$0.15
6515	Glaucum (Tulip Poppy). Vivid scarlet. 1 ft. ¼ oz. 25c	.10	6595	Sweet Briar. New double Begonia-flowered Shirley Poppy. Deep rose-pink15	
6518	Picotee. White edged scarlet. ¼ oz. 25c	.10	6596	salmonium. Double Shirley, salmon15	
6520	Shirley Selected Mixed. A much improved strain, with flowers of large size and from the most distinct and charming colors. The flowers are of a shining silky texture. 2 ft. ... ¼ oz. 25c.	.75c	6600	Exquisite Mixed. Beautiful shades and extremely double15	
6522	American Legion. Brilliant scarlet with white maltese cross Oz. 75c	.10	6605	Collection of ■ Double Varieties50	
6523	Apricot. A beautiful shade .. ¼ oz. 40c	.15		POPPIES, Hardy Perennial Varieties.	
6524	Blue Shades ½ oz. 35c	.15	6610	Alpine, Mixed. Pretty dwarf, free flowering sorts, in delicate colors. ½ ft. .25	
6525	Salmon Shades ¼ oz. 60c	.15	6615	Iceland nudicaule, Imperial Jewels Mixed. Beautiful border plant with bright, delicate colors, and if sown early will bloom the first year. 1 ft. ... ¼ oz. \$1.25	.20
6528	Picotee. White edged scarlet ... ¼ oz. 25c	.10	6618	Beauty of Belvedere. This new strain has flowers of largest size carried gracefully on long stems. The color range runs to the deeper shades, having a high proportion of cherry, flame, carmine and crimson; also tones of pink, rose, salmon and apricot. No white, yellow or orange35	
6530	The Bride. Large, pure white, 2 ft. Oz. 75c	.10	6622	Iceland, Coonara Pinks. Mixed hybrids in various shades of pink and yellow. Introduced from Australia; will bloom the same season from early spring sown seed25	
6532	Wild-Rose-Pink ½ oz. 25c	.10	6624	Iceland, El Monte. Very large, deep tangerine flowers borne on long, wiry stems. Comes true to color. Blooms in six months from seed. Fine ■■ cut flower.25	
6540	Collection of ■ Single Varieties50		6625	Orange Scarlet ¼ oz. \$1.25	.25
	POPPIES, Double Annual Varieties.		6630	Pure White ¼ oz. \$1.25	.25
6545	American Flag. Large, snow-white, fringed flowers, bordered with scarlet. 2 ft. Ooz. \$1.00	.10	6632	Yellow Wonder. The largest yellow Iceland Poppy. Flowers 4 to 6 inches across of bright buttercup-yellow. Plants 3 ft. high35	
6550	Cardinal Hybrids. Semi-dwarf, beautiful class, with large flowers in richest and brightest colors. 1½ ft. ¼ oz. 30c	.10	6637	The Emperor. Extremely large fluted-petaled flowers of deep orange25	
6555	Carnation-flowered mixed. Large, showy fringed flowers in choice colors. Oz. 75c	.10	6638	The Empress. Giant flowered with broad fluted petals. Lovely shades of salmon, rose and pink25	
6560	Japanese Pompon, Mixed. Beautiful, small double flowers. 1 ft. ¼ oz. 50c	.15	6639	Gartref Strain Mixed. Pastel colors, picotee markings25	
6570	Peony-flowered Mixed. Immense globular flowers; in choice colors. 2 ft. ... Oz. 75c	.10	6640	Oriente. Very large, brilliant scarlet with black blotch, ■ ft. ... ¼ oz. 70c	.10
6575	Pink. Immense bright pink. Oz. 85c	.10	6650	Livermore. Deep crimson ... ½ oz. 75c	.25
6580	Scarlet. Immense flowers. Oz. 85c	.10	6652	Mrs. Perry. Orange-apricot25	
6585	White. Immense, pure white ... Oz. 85c	.10	6654	Pink Beauty. Light pink. ... ¼ oz. \$1.00	.25
6590	Yellow. Immense, clear yellow .. Oz. 85c	.10	6655	Queen Alexandra. Bright rosy salmon	.15
			6656	Salmon Queen. Salmon-yellow. ½ oz. 50c	.15
			6670	White. New large white25	
			6675	Hybrids. Choice shades. ... ¼ oz. \$1.00	.15

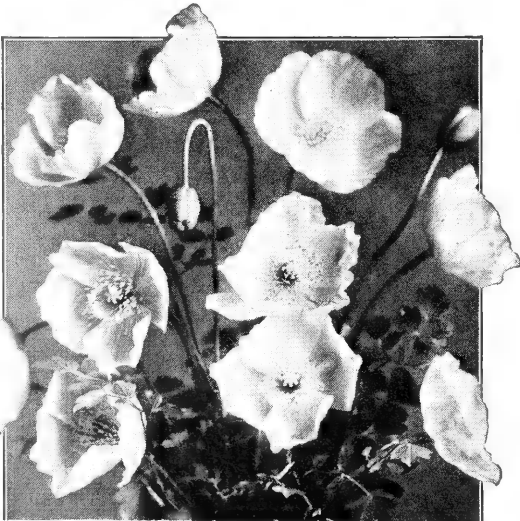

Iceland Poppies

	PORTULACA. One of our finest hardy annuals, specially adapted to light soils, dry, sunny situations and exposed rockeries. Flowers freely during the hottest weather. 6 in.	
6680	Double-flowered, Mixed. Perfectly double flowers in brilliant and striking colors	
6685	Single Large Flowered, Mixed.	¼ oz. \$1.00
6690	Rose ¼ oz. 50c, oz. \$1.50	.10
6695	Scarlet ¼ oz. 50c, oz. \$1.50	.10
6700	White ¼ oz. 50c, oz. \$1.50	.10
6705	Yellow ¼ oz. 50c, oz. \$1.50	.10
6710	Collection of 4 colors, separate35	
	POTENTILLA. A showy class of hardy perennials, producing in great abundance rich colored flowers of velvety texture.	
6715	Double Hybrids, Mixed. 2 ft.25

- No. Pkt.
- PRIMULA or PRIMROSE.** Hardy and half-hardy sorts. The following Primulas are exceedingly charming and useful plants for growing under glass or in the open air. Most of the hardy sorts require, in our climate, protection during winter.
- 6725 **auricula.** Saved from a large and varied collection of choice colors \$0.25
- 6730 **Garden Primrose, New Hybrids (Acaulis).** An excellent, large flowering strain of bright colors 1/8 oz. \$3.00 .25
- 6735 **Blue.** Clear blue color25
- 6740 **Yellow.** English Primrose .. 1/8 oz. \$1.50 .25
- 6745 **polyanthus, Giant Mixed.** New large flowering strain of the brightest colors .25
- 6755 **Gold Laced.** Yellow edged sorts15
- 6759 **Large-flowered Bedding Hybrids.** Dwarf upright26



Primula Polyanthus

- PRIMULA chinensis (Chinese Primrose).** All chinensis and stellata Primroses are grown for us by an English specialist who grows nothing but Primulas. For excellence in every point they cannot be equalled.
- 6760 **Grey's Giant Mixture.** A mixture of giant Primroses 1.00
- 6770 **Grey's Giant White.** The largest and best white ever sent out; flowers of great substance 1.00
- 6785 **Grey's Giant Salmon.** A distinct and valuable sort with massive trusses of salmon-pink flowers well above the foliage 1.00
- 6790 **Grey's Giant True Blue.** Beautiful fringed blossoms of immense size, fine substance and freely produced; the best blue 1.00
- 6795 **Grey's Orange King.** A grand new sort, said to be an entirely new color in Primulas, a beautiful orange color in bud and when open of a terra cotta shade with orange-salmon around the edge; very large and free 1.00

- No. Pkt.
- 6820 **Dazzler. New.** The most vivid of all flowers. The flowers are brilliant orange-red, produced well above the attractive foliage. About 20 blooms open at one time \$1.00
- 6825 **Double Dazzler.** Vivid orange-scarlet, comes true from seed 1.25
- 6835 **Giant King George V (New).** The darkest crimson yet offered, of giant size, beautifully fringed, very free flowering and of massive substance75
- 6840 **Giant Queen Mary (New).** One of the finest ever raised, erect, free flowering, of great substance, and of a lovely delicate flesh-pink color75
- PRIMULA stellata, or Star Primrose.** This valuable and very distinct variety should be extensively grown for greenhouse and table decoration. The innumerable star-shaped flowers make an effective contrast to the attractive dark foliage.
- 6855 **Blue Star Improved.** A strain of very large dark blue flowers and pale green foliage75
- 6860 **Brilliant Rose Star.** Bright rose flowers and graceful, dark green fern leaf foliage, which is red underneath75
- 6870 **King of Star.** Deep crimson75
- 6872 **Princess Marina.** Dark coral75
- 6875 **Salmon Pink Star.** Improved strain75
- 6880 **White Star.** Improved large, pure white75
- 6885 **Mixed Star.** A special mixture75



Primula Chinensis

No.		Pkt.
	PRIMULA obconica. A beautiful and continuous blooming variety with handsome spikes of flowers and pretty foliage. For winter blooming, seed should be sown in April or May.	
	Gigantea Type.	
6900	Mixed	\$0.50
6902	Coerulea, New Blue50
6904	Crimson King Improved50
6906	Deep Rosy Lilac50
6908	Eureka Salmon50
6914	Rosea50
6918	Wyaston Wonder, Crimson50
6916	White50
6940	forbesi (Baby Primrose). Rosy lilac, yellow-eyed flowers25
6942	Japonica Mixed. A fine hardy Primrose growing about 18 inches high. Flowers are borne in whorls 6-9 inches long...	.25
6945	PRIMULA kewensis. The flowers are bright yellow. Very fragrant, on erect stems 12 to 18 in. long50
	PRIMULA Malacoides. Very free flowering species and an excellent pot plant for indoor growing; the flowers are ½ to ¾ inches across.	
6946	Dawkin's Carmine50
6947	Dawn. Clear bright salmon50
6948	Double Rose50
6949	Double White50
6950	Light Lilac25
6952	Melody. Rose-pink, slight tinge of salmon.50
6954	Pink Beauty Improved35
6955	Princess Mary. Deep rose-pink50
6957	Snow King	1.00
6958	Spring. Mauve50
6959	Superba. Delicate lilac-pink30
6960	Swiss Wadenswil Compacta Carmine50
6961	Swiss Wadenswil Salmonea50
6962	Swiss Wadenswil Rose50
6963	Weihenstephan. Salmon-pink	1.00



Double Pyrethrum

No.		Pkt.
	PYRETHRUM. Handsome, hardy perennials. Indispensable for herbaceous borders or for cutting. They grow best in cool, moist situations, 2 ft.	
6972	Double Hybrids, Kelway's. Saved from their unequalled collection of named sorts	½ oz. \$1.50 \$0.50
6976	Single Hybrids, Kelway's. Superb large flowering sorts with immense single flowers of richest colorings. ½ oz. 75c25
6978	Single Crimson15
6980	Single Rose15
6982	Single White15
6995	RANUNCULUS, Double Mixed French. Beautiful double Buttercup-like flowers in great variety of choice colors; flowering first season from seed; hardy with protection. ¾ ft.	¾ oz. 75c .15
	RIBESIA Ss; Mignonette.	
7000	RHODANTHE, Mixed. Handsome pink and white, annual everlasting; excellent for bouquets of dried flowers. 1 ft.	¾ oz. 40c .10
7005	manglesi. Bright pink; beautiful	¾ oz. 60c .15
	RICINUS (Castor-oil Bean). Large, luxuriant, rapid growing foliage plants, palm-like leaves, brilliant colored fruit. In center of beds or singly on lawns, they produce a fine effect; half hardy annual.	
7010	borboniensis. Large, purplish green leaves. 15 ft.	oz. 40c .10
7020	gibsoni. Dark purple stems and foliage. 6 ft.	Oz. 35c .10
7030	anguinensis. Red stalks and fruit. ¾ ft.	Oz. 30c .10
7035	zanzibarensis, Mixed. A distinct race with enormous leaves varying in color from pale green to brownish purple	Oz. 25c, ¼ lb. 75c .10

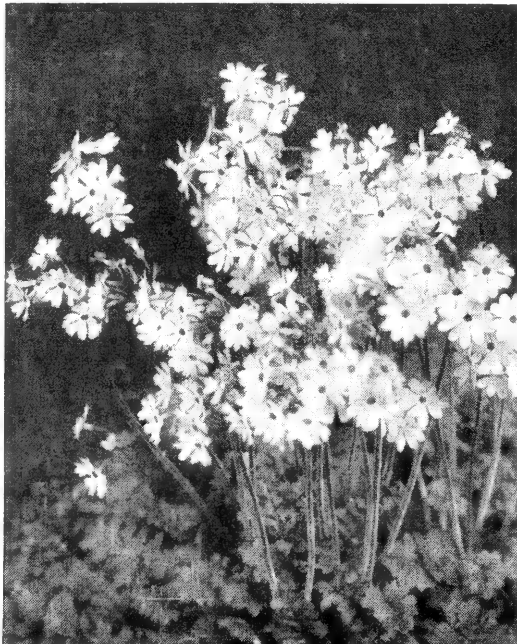

Primula Malacoides

No. 7045 **ROMNEYA coulteri** (Giant White California Poppy). Immense pure white, fragrant flowers, with golden center, blooming continually from June to September; makes a fine pot plant and requires protection in winter\$0.15

RUDEBECKIA (Coneflower). Beautiful border plants, lasting a long time in bloom and excellent for summer and autumn display; each bloom is like a miniature sunflower, 2 ft.

7050 **bicolor superba**. Orange-yellow with velvety brown center; annual. 1/4 oz. 50c .15

7051 **Hirta, Autumn Tints**. Well formed, large star flowers in all the autumnal shades on long, firm stems25

7052 **Kelvedon Star**. Annual. Deep golden yellow with mahogany zone, long-stemmed. Single and semi-double25

7054 **My Joy**. Bright orange flowers, sometimes 5 inches across, with small centers20

7055 **newmanni**. Golden yellow with velvety maroon center; hardy perennial15

7060 **SAINTPAULIA ionantha grandiflora**. Charming greenhouse plant, with beautiful deep blue flowers, 1 1/4 inches in diameter, resembling the violet50

SALPIGLOSSIS, Improved Large-Flowering. The large, richly colored flowers are elegantly veined and penciled, blooming from July to frost, and are splendid for cutting, 2 ft.

7061 **Collection Large Flowering Varieties**. Six colors75

7062 **Crimson** 1/4 oz. \$1.00 .15

7063 **Light Blue and Gold** 1/4 oz. \$1.00 .15

7064 **Primrose** 1/4 oz. \$1.00 .15

7065 **Purple, Golden Veined** 1/4 oz. \$1.00 .15

7068 **Rose Crimson and Gold, (New)**25

7070 **Rose, Golden Veined** 1/4 oz. \$1.00 .15

7075 **Scarlet, Golden Veined** 1/4 oz. \$1.00 .15

7078 **Velvet Violet** 1/4 oz. \$1.00 .15

7080 **Large-Flowering, Mixed** 1/4 oz. \$1.00 .15



Salpiglossis, Red Star Chamois

No. Pkt.

SALPIGLOSSIS, New Dwarf Giant Flowering.

Compact branching habit with flowers half again as large as the ordinary type. Plants are very free flowering and ideally suited for bedding.

7082 **Blue and Gold** \$0.25

7086 **Dark Brown and Gold**25

7087 **Deep Velvety Crimson**25

7087A **Khaki Yellow**25

7088 **Lilac**25

7088A **Red Star Chamois**. Delightfully colored with an over-all light chamois and pencilled with broad and narrow red stripes, with a deeper yellow throat, this new introduction presents one of the newer and unusual novelties we offer35

7089 **Scarlet and Gold**25

7089A **Velvety Violet**. Novelty35

7090 **Dwarf New Giant, Mixed**25

7092 **Collection, 6 varieties** 1.25

SALVIA. One of the handsomest and most showy summer and autumn flowering plants, forming compact bushes, literally ablaze with brilliant flowers from July to frost.

7098 **America (Globe of Fire)** 1/4 oz. \$1.25 .25

7099 **Blaze of Fire**. Earliest and most dwarf of all Scarlet Salvias35

7100 **farinacea**. Remarkable for its long flower spikes of lavender-blue, 3 feet. 1/4 oz. \$1.00 .15

7101 **farinacea, Royal Blue**35

7102 **farinacea, Blue Bedder**. Compact, deep blue; fine for bedding or borders. 1/4 oz \$1.50 .25



Salvia, America

SALVIA—Continued

No		Pkt.
7193	horminum violacea. Half-hardy annual. 2 ft. Violet-blue	\$0.15
7195	patens. Rich blue. 2 ft. ¼ oz.	\$1.75 .25
7110	splendens, Bonfire. Finest compact sort of very even growth, with dense spikes of vivid dark flowers. 2½ ft.	¼ oz. \$1.50 .20
7115	splendens, Fireball. Compact sort, with large, scarlet flower spikes, early and rich flowering. 2 ft.	¼ oz. \$1.75 .20
7118	Salmon-Pink. Blooms of large size and beautiful salmon-pink color on strong spikes. Blooms from mid-August until frost35
7120	splendens grandiflora. Large, brilliant scarlet flower spikes. The most popular sort grown. 3 ft.	¼ oz. \$1.00 .10
7122	splendens, Harbinger. Dwarf, compact, dazzling scarlet, dark foliage. Seeded in February will flower in June30
7135	Zurich. The very earliest flowering variety; rich scarlet and suitable for pot growing; very dwarf. 1 ft.	¼ oz. \$1.25 .25
7140	SANVITALIA procumbens fl. pl. Pretty free-flowering hardy annual, with double bright yellow flowers. 9 in.	¼ oz. 75c .15

SAPONARIA. Compact growing, hardy annuals, with small starry flowers from July to September.

7145	vaccaria. Beautiful pink feathery flowers. 3 ft.	¼ oz. 20c .10
7150	vaccaria alba. White-flowered; a fine market flower.	¼ oz. 20c .10

SCABIOSA, Improved Large-Flowering (Mourning Bride). One of our best summer flowering annuals. The rich and beautifully colored flowers are very handsome and excellent for cutting; profuse bloomer. June to October. 2½ ft.

7155	Azure Fairy. Delicate mauve10
7156	Blue Cockade. Pure deep azure-blue. 3 feet10
7157	Imperial Giants, Blue Moon. A new type with broad, heavy, wavy petals, making the flower fully double. Color rich deep lavender-blue. 42 to 48 inches	¼ oz. 35c .20
7160	Cherry Red. Bright color10
7166	Heavenly Blue. Distinct and lovely azure-blue, very early and free flowering. Plants are dwarf, 18 inches	¼ oz. 35c .20
7170	King of Blacks. Black-purple10
7172	Giant Loveliness. Flowers salmon-rose10
7174	Giant Orchid Shades	¼ oz. 35c .20
7175	Rose Pink. Beautiful shade10
7178	Peach Blossom. Peach-blossom-pink10
7181	Rosette. Rose suffused salmon.	¼ oz. 35c .20



Stock, Rose Standish

STOCK, Rose Standish New Early Flowering. Large two-inch florets on a clustered spike fifteen inches long with some 70% in doubles, the flower connoisseur will welcome this new branching type as a lovely new flower.

SCABIOSA, Improved Large-Flowering—Con't.

No.		Pkt.
7181A	Salmon Beauty. Huge flowers of pure salmon color	¼ oz. 35c \$0.20
7182	Shasta. Enormous white10
7186	Yellow.10
7190	Mixed. All colors10
7195	Collection of 6 Colors50
	Varieties, except where noted, ¼ oz., 25c.	
7200	SCABIOSA, Hardy Perennial Varieties. 2 ft.	
7202	caucasica. Beautiful lilac-blue	¼ oz. \$2.50 .15
	columbaria. A low growing pink Scabiosa, very large flowers30
7203	caucasica, Isaac House Strain Hybrid35
7204	caucasica. Pure white25
	SCHIZANTHUS (Butterfly Flower). Beautiful annuals for house or garden.	
7208	Canadian Super-Giants. Largest flowers of any strain, 2 in. across. Rich colorings and unusual markings	1.00
7210	hybridus grandiflorus. Very fine new large flowered varieties.	¼ oz. 75c .15
7215	Giant Hybrids, (Garaway's). A beautiful strain for greenhouses50
7218	Pansy-Flowered, Danbury Park Strain. Large blooms in great variety of rich self colors50
7220	wisetonensis. Most delicate shades of white, pink, rose and crimson; excellent for pot culture1/16 oz. \$2.00 .25
7221	wisetonensis. Dwarf, large flowering, mixed. 10 inches25
7225	Snowflake. Large, pure white, fringed35
7228	Pink Pearl.25
7229	roseus compactus. A fine greenhouse variety60

No.

STOCK

(Gilliflower). One of the most highly prized of all our cultivated flowers. The delightful fragrance, free-blooming character and beautiful colors have made them as desirable for winter cultivation in the greenhouse as for the garden in summer.

EARLY COLONIAL. Blooms about two weeks earlier than the Perpetual Branching class and grows 30-36 inches high. From the base of each plant 8 to 10 heavy 30-inch branches spread out and produce a plant 20 inches across, having no center spike. High percentage of doubles with large 2-inch florets on 15-inch spikes.

7301	Mayflower. Red-rose	\$0.25
7302	Furitan. Pure white25
7303	Priscilla. Silvery lavender25
7304	Rose Standish. Large bright rose25

See description and illustration, Page 34.

GIANTS OF CALIFORNIA. A new tall branching group rated highly for all forcing purposes. They are very early flowering, produce long branches if planted well apart and have extra long flowering spikes with immense individual florets. When planted close (4 inches apart) they grow over 3 feet, having only a single central spike with a 15 inch stem of florets.

7306	Golden Gate.20
7308	Mojave. Rich velvety purple or Elks' Pride35
7310	Monterey. Pink20
7312	Pacific. Deep blue20
7314	Red Woods. Blood-red20
7316	Santa Barbara. Chamois20
7318	Santa Maria. White20
7322	Sequoia. New rosy carmine20
7324	Tahoe. Lavender20
7326	Yosemite. Rose20
7328	Mixed.20
7329	Collection 6 Colors	1.00

Varieties, except where noted, 1/8 oz. \$1.00.

DOUBLE LARGE FLOWERING DWARF TEN WEEK. 1 ft. Ten Week Stock are so named because they bloom in ten weeks after planting seed. The best dwarf sort for summer bedding.

7332	Blood Red.15
7334	Deep Rose.15
7336	Flesh15
7338	Golden Wonder15
7342	Lavender.15
7344	Fansy Violet.15
7346	Pure White.15
7348	Mixed.15
7350	Collection of 6 Colors75

Separate Colors or Mixed, 1/8 oz. 60c

MAMMOTH BEAUTY OF NICE. Splendid strain for garden or greenhouse, of fine branching habit, with very large, double fragrant flowers. An unusually long and free blooming strain. 2 ft.

7351	Collection of Six Separate Colors75
7353	Apricot Special Forcing. 2 1/2 to 3 ft. Delicately tinged pink; fragrant35
7354	Belle of Naples. Old rose15
7355	Beauty of Nice. Flesh-pink15

Pkt.

No.

7358	Mont Blanc. White	1/8 oz.	\$1.00	\$0.15
7362	Cote d'Azur. Light blue	1/8 oz.	\$1.00	.15
7365	Crimson King. Rich crimson	1/8 oz.	\$1.00	.15
7370	Monte Carlo. Yellow	1/8 oz.	\$1.00	.15
7375	Queen Alexandra. Mauve	1/8 oz.	\$1.00	1/4 .15
7376	Summer Night. Deep blue	1/8 oz.	\$1.00	.15
7377	Violet of Nice. Dark violet	1/8 oz.	\$1.00	.15
7378	Mixed	1/8 oz.	\$1.00	.15

STOCK, DOUBLE GIANT EXCELSIOR. (Improved Column Type). 3 ft. Non-branching. Each plant produces one large flowering spike. Robust habit and uniform type with a high percentage of doubles.

7379	Mixed.			
7379A	Chamois-pink.			
7380	Crimson	1/8 oz.	\$2.00	.25
7385	Dark Blue	1/8 oz.	\$2.00	.25
7388	Gardenia. New	1/8 oz.	\$2.25	.30
7389	Golden Rose. New	1/8 oz.	\$2.00	.25
7396	Lilac-Lavender	1/8 oz.	\$2.00	.25
7392	Moonlight. Yellow	1/8 oz.	\$2.00	.25
7395	Rose-Pink	1/8 oz.	\$2.00	.25
7396	Ruby	1/8 oz.	\$2.00	.25
7400	Snow White	1/8 oz.	\$2.00	.25
7400A	Collection 6 Colors			1.25

STOCK, GIANT IMPERIAL or BISMARCK IMPROVED. Large branching habit Early forcing. 2 1/2 ft.

7401	Apple Blossom.	1/8 oz.	\$1.00	.15
7402	Blood Red	1/8 oz.	\$1.00	.15
7403	Bright Rose.	1/8 oz.	\$1.00	.15
7404	Dark Blue.	1/8 oz.	\$1.00	.15
7406	Light Blue.	1/8 oz.	\$1.00	.15
7407	Peach Blossom.	1/8 oz.	\$1.00	.15
7409	White.	1/8 oz.	\$1.00	.15
7411	Yellow.	1/8 oz.	\$1.00	.15
7416	Mixed Colors.	1/8 oz.	\$1.00	.15
7418	Collection of 6 Colors75

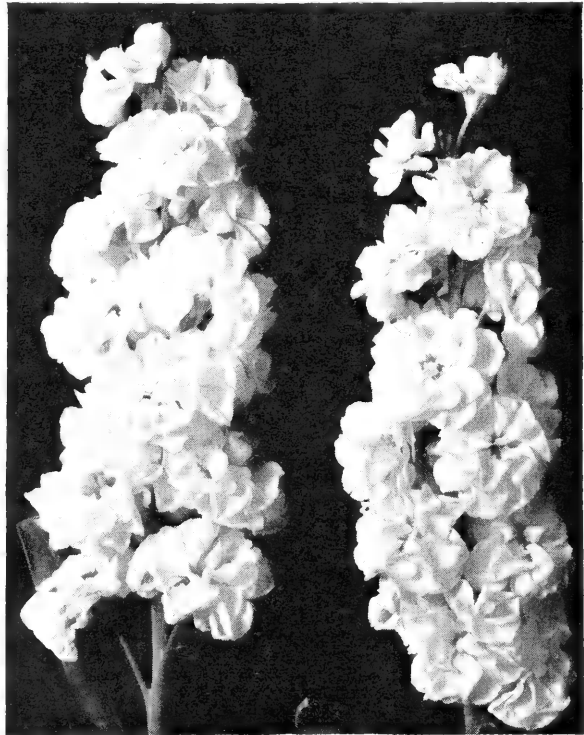

Stocks, Giants of California

No.		Pkt.
7235	SEDUM (Stonecrop). Mixed . Suitable for rock work, edgings and dry situations; their glaucous foliage and bright flowers invariably attract attention; hardy perennial 4 in. ¼ oz. \$1.25	\$0.20
7238	acre . Bright yellow. 3 in., hardy25
7240	coeruleum . Blue-flowered annual variety25
7241	spectabile . 1 ft. Perennial. Large lavender-pink25
7245	SHAMROCK . True, small leaved variety; imported seed	¼ oz. 50c .10
7248	SIDALCEA hybrida . Hardy, 2½ to 3 ft. June-July. In many shades of rose, pink, red, salmon, lilac25
	SILENE (Catchfly). Very pretty and profuse blooming plants.	
7250	armeria , Mixed . Hardy annual pink, white and red flowers	¼ oz. 25c .10
7255	pendula , Feach Blossom	¼ oz. 35c .10
7260	orientalis . Perennial with beautiful pink flowers; blooms from June to August and is fine for cutting	¼ oz. 50c .10
7265	SMILAX (Myrsiphyllum asparagoides). A climbing plant unsurpassed for its graceful foliage and orange blossom fragrance of its flowers	¼ oz. 35c .10
7275	SOLANUM capsicastrum nanum (Jerusalem Cherry). Very ornamental plants for house or greenhouse, being almost completely covered with bright scarlet berries	¼ oz. 50c .10
7280	Cleveland . Very large, brilliant berries ..	.15
7282	Hlavocek's Masterpiece . Large scarlet ..	.15

No.		Pkt.
7284	STATICE (Sea Lavender). Dumosa . Perennial. 2½ ft. Pure silvery grey	\$0.25
7285	Mixed . Beautiful hardy perennial10
7290	latifolia . Deep lavender-blue .. ¼ oz. 40c	.10
7290A	sinuata , Annual Mixed	¼ oz. 40c .15
7291	sinuata , Blue	¼ oz. 40c .15
7291A	sinuata , Lavender	¼ oz. 40c .15
7292	sinuata , Rose	¼ oz. 40c .15
7293	sinuata , White	¼ oz. 40c .15
7293A	suworowii (Russian Statice). Annual. Tail-like spikes of pink flowers15
7294	bonduellii . Yellow15
7300	STEVIA . Free flowering greenhouse perennials, with sprays of tiny flowers. 2 ft. serrata . Pure white, fragrant15
7423	STONISIA cyanea (Cornflower Aster). Beautiful hardy perennial with lavender-blue blossoms. 16 in. .. ¼ oz. \$1.50	.25
7425	STREPTOCARPUS , Veitch's New Hybrids . Handsome greenhouse perennial, with Achimene-like flowers in clusters75

SWEET PEAS

1941 NOVELTY SWEET PEAS, SUMMER FLOWERING.

No.		Pkt.
7628	Linconian . Soft pale cerise	\$0.25
7696	Red Supreme . Bright luminous red ..	.25
7715	Salmon Gigantic . Enormous size, waved and frilled25
7730	Spicy . Lovely soft shell-pink25

No.		Pkt.
7450	Special Exhibition Mixture . This mixture is made up entirely of the Spencer types and includes the finest sorts and most effective colors. Oz. 25c; ¼ lb. 75c; lb. \$2.50	\$0.10
	Separate Varieties . Oz. 30c; ¼ lb. \$1.00.	
7455	Ambition . Blue-lavender10
7470	Avalanche . Glistening pure white10
7475A	Begonia Rose . Amber base10
7480	Bonfire . Cherry-pink, cream wings ..	.10
7482	Bonnie Briar . Sparkling rose-pink ..	.10
7498	Cattleya Queen . Orchid.10
7525	Crony . Soft golden salmon10
7512	Chinese Blue . Rich deep blue10
7535	Defiance . Orange-scarlet10
7555	Flamingo . Scarlet-cerise10
7556	Flora . Clear lilac-lavender self10
7558	Fluffy Ruffles . Giant rose and salmon ..	.10
7560	Fortune . Dark blue10
7562	Gigantic . Large pure white, black seeded.10
7565	Gleneagles . Light blue-lavender10
7570	Glengarry . Deep velvety crimson10
7572	Golden Dragon . Bright orange-rose ..	.10
7575	Grand National . Large frilled cream ..	.10
7590	Hawlmart Pink10
7600	Hawlmart Scarlet10
7625	King White . Giant wavy white10
7630	Magnet . Cream-pink10
7670	Mrs. Tom Jones . Delphinium-blue10
7675	Olympia . Rich purple10
7685	Pinkie . Large rose-pink10
7688	Pirate Gold . Golden-orange10
7690	Powerscourt . Lavender10
7700	Reflection . Clear blue10
7710	Royal Purple10
7725	Smiles . Salmon-shrimp-pink10
7728	Snow White . Black seeded10
7755	Warrior . Giant red-maroon10
7765	What Joy . Cream-yellow10
7768	Windsor Blue . Clear mid-blue10
7775	Youth . Large white, picotee rose-pink ..	.10

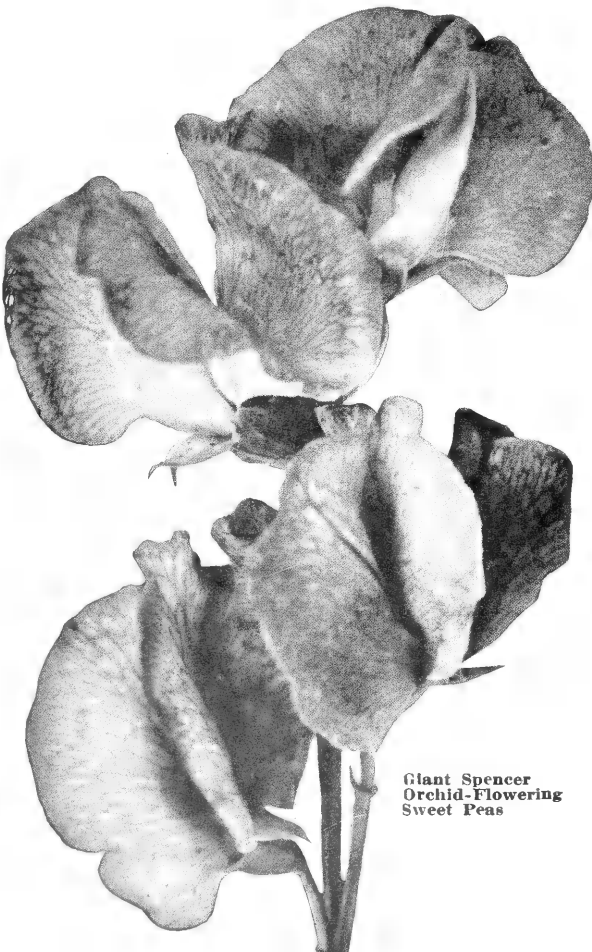

Giant Spencer
Orchid-Flowering
Sweet Peas

SWEET PEAS—Continued
SPENCER VARIETIES FOR GREENHOUSE

NOVELTIES: Oz. \$1.00; pkt. 25c each

- 7822 **Cavalcade.** Rich golden cerise.
- 7823 **Cascade.** Long stems, pure white.
- 7838 **Hiawatha.** Deep rose self.
- 7840 **Hortus Queen.** Bright rose, cream ground.
- 7875 **Skippy.** Light salmon-pink, long stems.
- 7876 **Sterling.** Duplex salmon-rose.

Separate varieties listed below: ¼ oz. 25c; oz. 75c.

No.		Pkt.
7808	Annie Laurie. Deep rose-pink	\$0.15
7811	Ball Blue.	.15
7812	Ball Orange Improved.	.15
7814	Ball Rose Improved	.15
7818	Blue Bonnet. Clear blue	.15
7819	Blue Danube. Mid-blue self, ruffled	.15
7820	Boon. Deep salmon-pink	.15
7821	Bridesmaid. Deep silvery pink	.15
7825	Claret Cup. Pansy-purple	.15
7828	Colossal Rose. Largest rose-pink	.15
7830	Eileen. Rich begonia-rose	.15
7831	Eleanor Blue. Sky blue, long stem	.15
7832	Evening Star. Bright orange-scarlet	.15
7833	Exposition Pink. Rich pink	.15
7834	Fragrance. Clear lavender self	.15
7835	Glitters. Fiery cerise	.15
7836	Grenadier. Poppy-scarlet	.15
7839	Hope. Pure white, black seeded	.15
7841	Iris Blue. Wavy, deep iris-blue	.15
7844	Lavanda. Clear lavender	.15
7845	Lavender Harmony.	.15
7852	Majestic Rose. Brilliant pink	.15
7855	Mars. (New.) Ox-blood-crimson	.15
7857	Mrs. Herbert Hoover. Bright blue	.15
7858	Oriental. Deep cream, black seeded	.15
7860	Princess Blue. Belladonna-blue	.15
7864	Rose Picotee. Salmon-rose on white	.15
7873	Sequoia. Rich golden cerise	.15
7874	Shirley Temple. Rose-pink	.15
7877	Tahoe. Mid-blue self	.15
7878	Titania. Mammoth deep rose self	.15
7880	Top Hat. Deep velvety violet-blue	.15
7884	Treasure Island. Golden orange	.15
7892	Valencia. Sunproof orange	.15
7895	White Harmony. White, black seeded	.15
7910	Mixed.	.15



Sweet William, Boston Giant

No.		Pkt.
	SWEET WILLIAM. Popular and showy hardy biennial of easiest culture, producing their brilliant colored flowers in great profusion; very desirable for borders and old-fashioned gardens 1½ ft.	
8055	Boston Giant Mixed	\$0.25
8058	Dwarf Sweet William. 9 in. Single mixed	.15
8060	Double Mixed. Very large flowers.	.15
 ¼ oz. 75c	
8065	Holborn Glory. Extra large flowers, finest colors, clearly defined eyes	.10
 ¼ oz. 50c	
8070	Single Finest Mixed	.10
 ¼ oz. 50c	
8075	Dark Crimson	.10
 ¼ oz. 50c	
8080	Deep Velvety Maroon	.10
 ¼ oz. 75c	
8082	Newport Pink. Soft salmon-pink	.25
8085	Pure White	.10
 ¼ oz. 75c	
8090	Pink Beauty. Soft pink	.25
 ½ oz. 75c	
8095	Scarlet Beauty. Vivid	.25
 ½ oz. 75c	
8100	Annual Mixed. Seed sown in March will bloom the same year. 9 in.	.15
 ¼ oz. 75c	
8101	Tahoka Daisy. Big daisies of pure blue-lavender with yellow centers, fern-like foliage and good cutting flower stems. Blooms from mid-June to autumn	.15
8102	THALICTRUM dipteroarpum. 3½ ft. Ornamental foliage and sprays of dainty graceful flowers of violet-mauve with yellow stamens and anthers	.15
8103	THERMOPSIS caroliniana. Long spikes of bright yellow flowers. Perennial. 4 ft.	.25
	THUNBERGIA (Black-Eyed-Susan). Beautiful free flowering annual twiners of rapid growth, used extensively in window boxes, vases, etc. 4 ft.	
8110	alba. White, with dark eye	.10
 ¼ oz. 65c	
8115	aurantiaca. Orange, dark eye	.10
 ¼ oz. 65c	
8118	Gibsoni. Large flowers of rich glowing orange	.35
 ¼ oz. 50c	
8120	Mixed. All colors	.10
 ¼ oz. 50c	
8122	TITHONIA speciosa, Fireball. Plants 8 to 9 feet, with heavy growth of grayish green woolly foliage. Flowers brilliant scarlet-orange, 4½ to 5 inches across	.25
8123	speciosa. Golden flower of the Incas. Annual 6-8 ft. tall, fine for background. Flowers single, orange-vermilion	.25
	TOENIA. Beautiful free flowering, tender annuals, suitable for pot culture in house or conservatory, also excellent for the border and for baskets and vases. June to October. 1 ft.	
8125	ballioni. Golden yellow, purple throat	.25
8130	fournieri grandiflora. Bright blue, with dark blue spots, bright yellow throat	.25
8135	White Wings. Blush-white, yellow throat	.25
8138	TRACHELIUM coeruleum. Half-hardy annual. May be grown in greenhouse or out-of-doors in sheltered place. Plants have large cloud-like heads of tiny blue flowers	.35



Shirley Temple

No.		Pkt.
8140	TRITOMA semperforens (Flame Flower). Perpetual flowering, showy perennial. Numerous spikes of orange-red flowers from July until frost. 3 to 4 ft.	\$0.15
8145	hybrida mirabilis . Dwarf annual ranging from lemon-yellow to deep orange. Sown early, they bloom freely from July until frost. 2 feet15
	TROLLIUS (Globeflower). Charming spring flowering, hardy perennials, with large globular Buttercup-like flowers.	
8150	Orange Globe . Large, deep orange25
8155	Mixed Hybrids . Large flowered varieties.25
8160	TROPAEOLUM canariense (Canary-creeper). Elegantly fringed, bright yellow flowers. 10 ft.	Oz. 50c .10
8163	URSINIA anethoides . Pretty daisy-like flower from South Africa, bright orange with a purple zone. Height 10 inches.25
8165	VALERIAN, Mixed . Showy, hardy perennial with long spikes of heliotrope-scented flowers. 2 ft.	¼ oz. 35c .10
8170	officinalis (Garden Heliotrope). Large trusses of fragrant pink flowers. 3 ft.25
8173	VENIDIUM fastuosum . Annual. 2-3 feet. Deep orange daisy-like flowers 4-5 inches across with upper row of petals marked with reddish brown zone.25
8174	VERBASCUM phoeniceum Hybrids . Perennials. Plants 3 ft. high with colors ranging from white, pink, rose, purple and bronze to brown	¼ oz. 35c .15
	VERBENA hybrida grandiflora (Giants) . A magnificent strain of Verbenas, of robust, compact habit and free blooming. The trusses are immense, the individual florets measuring an inch in diameter. Seed sown in March will bloom from June until frost.	
8175	Grey's Mammoth, Mixed . A grand strain of giant Verbenas	¼ oz. 75c, oz. \$2.50 .10
8177	Beauty of Oxford Hybrid . Rose-pink shading to rose-red,	¼ oz. 50c .25
8178	Blue . White eye	¼ oz. 75c .10
8180	Brilliant . Rich, deep flame-rose, with white eye20
8182	Flamingo . Vivid rose-pink; long stems and large flowers20
8183	Giant Apple Blossom15



Viola Cornuta

No.		Pkt.
8184	Giant Salmon Pink	¼ oz. 75c \$0.15
8186	Lavender Glory . Creamy eye	¼ oz. 50c .20
8188	Mayflower Pink	¼ oz. 75c .10
8190	Rose Cardinal . Rose, white eye	¼ oz. 75c .10
8192	Royale hybrida . Royal blue, yellow eye.	½ oz. 50c .15
8194	Scarlet Queen . Very large	½ oz. 60c .20
8196	Snow Queen . Very large	½ oz. 60c .15
8198	Spectrum Red . Intense scarlet, no eye ..	.20
	VERBENA hybrida, Dwarf compacta (Erect) . 7 inches.	
8202	Blue Sentinel . Rich royal violet-blue; fragrant20
8204	Fireball . Erect, bright scarlet20
8206	Violet Bouquet . 8 in. Deep violet20
8208	White Ball . New25
8210	Dwarf compacta Mixed20
8211	Bonariensis . (New). Perennial species. The slender freely-branched stems, 4 or 5 ft., bear sprays of heliotrope flowers during July and August25
8212	erinoides (Moss Verbena). 1 ft. Purple15
8214	erinoides alba . 1 foot.	½ oz. 30c .15
8215	Lemon Verbena (Aloysia citriodora). Fragrant foliage for cutting25
8221	venosa lilacina	½ oz. 50c .25
8222	venosa . Purple	¼ oz. 50c .15
	VERONICA . Splendid hardy perennials, with showy spikes of bright colored flowers; fine border plant. 1½ to 2 ft.	
8225	spicata Blue . Bright blue20
8227	spicata, Mixed20
	VINCA . Handsome, profuse blooming half-hardy perennials, flowering the first season from seed.	
8235	Bright Rose	¼ oz. 75c, oz. \$2.50 .15
8240	Pure White	¼ oz. 75c, oz. \$2.50 .15
8245	White, with Rose Eye	¼ oz. 75c, oz. \$2.50 .15
8250	Mixed . All colors	¼ oz. 75c, oz. \$2.50 .15
	VIOLA cornuta (Tufted Pansies). Fine flowering plants, excellent for partially shaded beds or borders, blooming throughout the season; harder than other Pansies, but with smaller flowers.	
8255	Admiration . Rich, dark blue	¼ oz. \$1.75 .15
8260	Blue Perfection . Light blue	¼ oz. \$1.75 .15
8265	lutea . Old yellow sort	¼ oz. \$1.50 .15
8265A	Mauve Queen15
8266	Papilio . Deep violet15
8270	rosea . Delicate rose	¼ oz. \$1.75 .15
8275	White Perfection . Large white.	¼ oz. \$1.50 .15
8280	Mixed . Finest varieties	¼ oz. \$1.25 .15
8282	Arkwright Ruby . Terra cotta on crimson ..	.25
8283	Hybrida Chantreyland . Pure apricot ..	.25
8285	Scotch Strains . Choicest and newest bedding hybrids in finest colors25
8286	Shakespeare Pansy . Small old-fashioned tricolor variety as grown in the gardens of Shakespeare's time25
8287	Sutton's Bedding Apricot . Rich apricot ..	.35

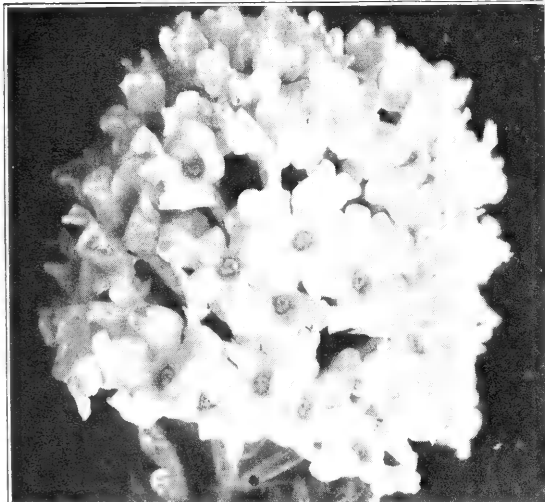

Grey's Mammoth Verbena

No.	VIOLA—Continued	Pkt.
8288	Viola, Jersey Gem. A large, deep violet-blue; fine for rockery and border	\$0.35
	VIOLA odorata (Sweet Scented Violet). Hardy perennial, easily grown from seed, doing best in cool, moist situation.	
8295	The Czar. Very large dark blue. 1/4 oz. 85c	.15
8300	White Czar. Very large white. 1/4 oz. 75c	.15
8308	VIOLA Gracilis, Sapphire. Resembles Viollettas with sapphire-blue flowers. Blooms throughout the spring and summer35
8310	VIRGINIAN STOCK, Mixed. 1/4 oz. 75c	.15
8312	Crimson Gem. 8 in. Erect and compact.	.15
8315	VISCARIA, Finest Mixed. Showy, free flowering hardy annual, for border or masses. 1 ft.	1/4 oz. 25c .10
8316	Blue Pearl. Pure delicate lavender-blue.	.25
8317	Fire King. Bright scarlet25
8318	Innocence. Compact pure white25
8319	Rose Beauty. Petals fringed25
8319A	Tom Thumb Blue Gem. Ultramarine-blue.	.25
	WALLFLOWER. Delicately fragrant half-hardy perennials, with beautiful velvety flowers.	
8320	Double Branching, Mixed. 1/4 oz. \$1.50	.25
8325	Kewensis. Sulphur-yellow to purple25
8330	Vulcan. Velvety crimson-brown flowers.15
	WALLFLOWER, Annual. Early flowering single varieties which bloom throughout the summer from spring-sown seed.	
8335	Blood Red 1/4 oz. 50c	.25
8340	Earliest Paris. Fine brown. 1/4 oz. 50c	.25
8345	Golden Yellow 1/4 oz. 50c	.25
8350	Mixed, All colors 1/4 oz. 50c	.15
8352	Double Early Wonder Mixed. 2 ft. Blooms within three months 1/4 oz. 50c	.15
8355	XANTHISMA Texanum (Star of Texas). A continuous mass of glistening golden blossoms. 15 in. Annual20
8370	YUCCA filamentosa (Adam's Needle). Hardy perennial. The large, white, waxy flowers are borne in huge panicles above the sword-shaped foliage15

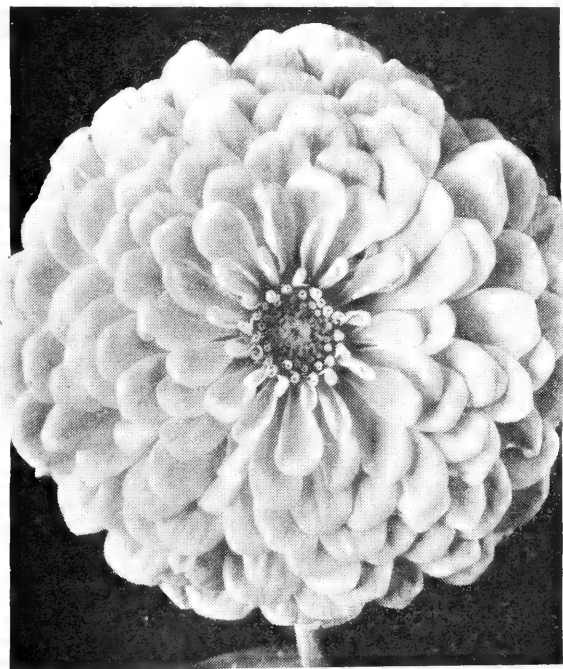

Giant Flowered Zinnia

No.	ZINNIA. These attractive and decorative hardy annuals are most desirable for borders or bedding; remarkable for the profusion and duration of their flowers.	1/2 oz.	Pkt.
	Giant Dahlia-Flowered.		
8375	Collection. 12 varieties		\$1.50
8376	Will Rogers. Brilliant scarlet35	.15
8380B	Canary Bird. Delicate primrose.35	.15
8381	Crimson Monarch35	.15
8382	Dream. Deep lavender35	.15
8383	Exquisite. Light rose, deep center.35	.15
8383A	Golden Dawn. Golden yellow35	.15
8384	Golden State. Orange-yellow35	.15
8384A	Illumination. Deep rose self color35	.15
8384B	Lemon Beauty. Pastel shade.35	.15
8384C	Luminosa. Bright deep pink, light suffusion of salmon35	.15
8385	Meteor. Glowing deep red35	.15
8386	Oriole. Orange and gold35	.15
8387	Polar Bear. Pure white35	.15
8387A	Purple Prince. A deep purple35	.15
8387B	Scarlet Flame. Bright scarlet35	.15
8387C	Youth. Light pink35	.15
8388	Special Mixture35	.15
	Double Giant Flowering Columbia Strain. Saved from selected prize flowers. 2 ft.	1/4 oz. \$0.50	\$0.10
8389	Bright Rose50	.10
8389A	Burnt Orange50	.10
8395	Crimson50	.10
8400	Deep Ruby Red50	.10
8405	Flesh Pink50	.10
8410	Golden Yellow50	.10
8415	Light Canary50	.10
8420	Violet50	.10
8425	Scarlet50	.10
8430	Salmon Rose50	.10
8435	White50	.10
8440	Columbia Prize Mixture50	.10
8442	Pastel Shades, Mixed50	.10
8445	Collection 12 Varieties		1.00
8446	Desert Gold (Crown of Gold type). Light and deep hues of gold60	.15
8447	Fantasy Mixed. A mixture of bright and pastel shades of shaggy petaled, medium sized double flowers50	.20
8447A	Star Dust. Deep golden yellow20
8447B	Orange Lady. Deep bright orange.15
8447C	Rosalie. Bright, intense rose15
8447D	White Light15
8447E	Wildfire. Rich, dazzling scarlet15
8448	Super Crown O' Gold, Pastel Tints. Large, showy blooms in soft yellow, old gold, light pink, apricot-pink, various shades of salmon, peach and buff15
8448A	Scabiosa-Flowered, Autumn Tints Mixed. Flowers have wider outer rays, but the inner section has tubular florets. Orange-bronze, russet, dull red, carmine, terra cotta and intermediate shades15
8499	Harmony Type, Campfire. Scarlet20
	Cut-and-Come Again Varieties		
8450	Dwarf Crimson. 1 ft.50	.10
8455	Bright Rose Pinkie (New)50	.10
8458	Canary Yellow50	.10
8465	Dazzling Scarlet50	.10
8470	Flesh Pink50	.10
8475	Golden Orange50	.10
8478	Salmon Rose50	.10
8480	White50	.10
8485	Mixed. All colors.50	.10
8490	Collection of 6 Colors50
	Early Wonder. Dwarf early flowering Zinnias producing masses of medium size flowers. 1/8 oz.		
8498	Fandango. Fiery salmon-cerise.	\$0.40	\$0.20
8499	Gypsy. Deep burnished orange.40	.20
8500	Padre. Bright, dazzling scarlet.40	.20

No.	ZINNIA—Continued	¼ oz.	Pkt.
8502	Gracillima, Dwarf Red Riding Hood	\$0.30	\$0.10
8503	Gaillardia Flowered (Navajo) Flowers resemble a <i>Picta</i> Double Gaillardia, in both form and color15
8504	Lilliput, Tom Thumb Mixed. Plants are only 4 to 6 inches high, and covered with well formed flowers.	.50	.20
8505	Lilliput, Mixed. Very small, double, fine for borders, 1½ ft.50	.15
8506	Lilliput Pastel Shades. Lovely soft shades of apricot-peach, creamy yellow, shell, delicate salmon, light rose and orchid in mixed colors50	.15
8507	Collection 6 Colors75
8508	Canary Yellow50	.15
8510	Crimson Gem. Deep crimson50	.15
8512	Deep Flesh50	.15
8515	Golden Gem. Golden yellow50	.15
8516	Lilac Gem50	.15
8517	Rosebud. Rose-pink50	.15
8518	Salmon Rose Gem50	.15
8520	Scarlet Gem. Dazzling scarlet50	.15
8522	Valencia. Burnt orange50	.15
8525	White Gem. Pure white50	.15
		⅓ oz.	Pkt.
8526	Pumila Picotee, Delight Mixed. A dwarf double type in shades of salmon, yellow and lavender, flowers not so large and stems more slender than the ordinary type; extra fine for cut flowers	\$0.35	\$0.15
8526A	Pumila Picotee, Salmon Rose35	.15
8526B	Pumila Picotee, Golden Ray35	.15
8527A	Single Linearis. Charming little golden-orange flowers with a lemon-yellow stripe through each petal, and having a dark brown center. Plants grow 8-10 inches high and attain a spread of 2 ft., producing a showy profusion of flowers. Attractive for borders or edging20
8528	Double Mexican, haageana hybrida Mixed. 1 ft. Small, double blooms of unusual coloring35	.15
	CALIFORNIA GIANTS. Flowers very graceful, large, flat, with small, flat center. Height 3 to 4 ft.		
8600	Cerise Queen35	.15
8605	Daffodil. Canary-yellow35	.15
8610	Enchantress. Light red, deeper rose center35	.15
8615	Golden Queen. Golden lemon35	.15
8620	Grenadier. Bright dark red35	.15
8625	Lavender Queen. Deep lavender35	.15
8630	Miss Willmott. Soft pink35	.15
8635	Orange Queen. Golden orange35	.15
8640	Purity. White35	.15
8645	Salmon Queen. Salmon-rose35	.15
8650	Mixed Colors35	.15
8660	Collection of 10 Separate Varieties		1.25

Mixed Flower Seeds for Wild Gardens

"Wild Gardens" have proved a marked success, and we are in receipt of the most satisfactory evidence of the estimation in which they are held. Anyone who has cultivated flowers knows the constant attention necessary in the care of well laid out beds and borders. To those who cannot give this care, the "Wild Garden" presents a substitute which, for its unusual and varied effects, cheapness, and the small amount of labor necessary for its construction, has no rival.

- 8530 **Dwarf Sorts.** ½ oz. pkts., each 15c, oz. 25c, 4 ozs. 85c, lb. \$2.50.
- 8535 **Tall Sorts.** ½ oz. pkts., each 15c, oz. 25c, 4 ozs. 85c, lb. \$2.50.

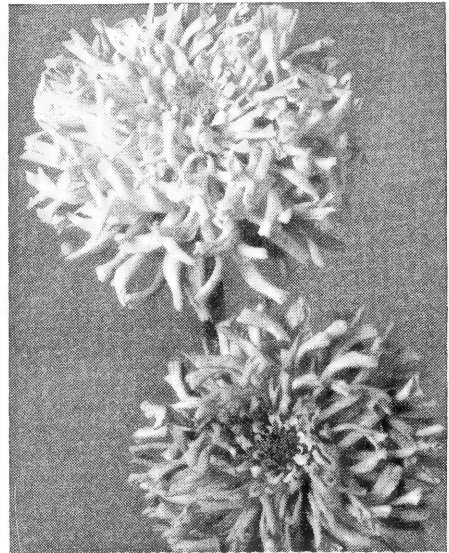

Zinnia, Fantasy, Star Dust

Ornamental Grasses

For borders and ornamental gardening; also, when dried, for winter bouquets and decorations, for which purpose they should be gathered before fully matured.

No.		Pkt.
8670	Finest Mixed. In variety, for bouquets . . .	\$0.10
8680	Arundo donax variegata. Variegated foliage; half-hardy perennial. 7 ft.10
8695	Coix lachryma (Job's Tears). Striped leaves; annual. 2 ft.10
8700	Eulalia japonica zebrina. Beautiful variegated leaves with yellow bars running crosswise; half-hardy perennial. 1 ft.10
8705	Gynerium argenteum (Pampas Grass). Large, silvery plume; half-hardy perennial. 10 ft.10
8710	Hordeum jubatum (Squirrel's Tail). Annual. 2 ft.10
8715	Lagurus ovatus (Hare's Tail). Annual. 1 ft.10
8720	Fennisetum ruppelianum. Crimson-purple plumes, from spring-sown seed15
8725	Stipa pennata (Feather Grass). 2 ft.15

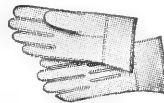

Dirt-Proof, Washable GARDEN GLOVES

All Leather Durable Easy to Wear —for Men and Women

Easy Wear gives you everything you want in a garden glove: all-leather protection from dirt, scratches, stains, infection—yet permit almost BAREHAND FREEDOM. Their amazing softness and pliability are the result of a special processing of select lamb skins. Economical, too—outwear 6 pairs of ordinary fabric gloves, are washable and can be used the year round for gardening, housework, painting, furnace, garage, etc.

Sizes for WOMEN and MEN. Price 75 Cents a Pair. **Eazy Wear NATIONAL GLOVES**

KREMÉ SKIN BEAUTY GLOVES (Cream treated). Made of extra-soft, imported lamb skins specially treated to give them a moderate lanolin (cold cream) content. They beautify the hands while you work or play. \$1.00 a pair. **GENUINE HORSEHIDE PRUNING GLOVES.** \$1.50 a pair. With gauntlets, \$2.00 a pair.

NEW AND CHOICE VEGETABLE SEEDS

Our standard strains of Vegetables are acknowledged to be unsurpassed, not only for reliability in cropping, but for the good appearance, fine flavor, and superior quality when served at the table.

Grey's Collections of Choice Vegetable Seeds

(NOTICE—These Collections are sold as listed and priced. No changes can be made.)

These collections we have listed are to help those of our customers, who prefer to have us make the selection from our standard varieties. Each collection listed here should yield the grower for a long period of time an abundance of wholesome, fresh Vegetables of superior quality and flavor.

Grey's City Garden Collection **\$1.25**

15 Varieties, Postpaid

Will plant a plot 25 ft. by 50 ft.

- 1 pkt. Dwarf Beans, Bountiful
- 1 pkt. Dwarf Beans, Sure Crop Wax
- 1 pkt. Beet, Early Wonder
- 1 pkt. Carrot, Danvers Half Long
- 1 pkt. Corn, Golden Bantam

- 1 pkt. Cucumber, White Spine
- 1 pkt. Kale, Dwarf Green Curled
- 1 pkt. Lettuce, White Boston
- 1 pkt. Onion, Yellow Globe
- 1 pkt. Parsley, Double Curled

- 1 pkt. Peas, Sutton's Excelsior
- 1 pkt. Radish, Scarlet Globe
- 1 pkt. Spinach, New Zealand
- 1 pkt. Swiss Chard
- 1 pkt. Turnip, White Globe

Grey's Cottage Garden Collection **\$2.75**

30 Varieties, Postpaid

Will plant a plot 25 ft. by 100 ft.

- ½ lb. Dwarf Beans, Bountiful
- ½ lb. Dwarf Beans, Fordhook Lima
- ½ lb. Dwarf Beans, Sure Crop Wax
- 1 oz. Beet, Crosby's Egyptian
- 1 pkt. Cabbage, Golden Acre
- 1 oz. Carrot, Imperator
- 1 pkt. Corn, Golden Bantam
- 1 pkt. Corn, Golden Evergreen
- 1 pkt. Cucumber, Davis Perfect
- 1 pkt. Kale, Dwarf Green Curled

- 1 pkt. Kohlrabi, White Vienna
- 1 pkt. Leek, Musselburgh
- 1 pkt. Lettuce, May King
- 1 pkt. Lettuce, White Boston
- 1 pkt. Melon, Bender's Surprise
- 1 pkt. Watermelon, Cole's Early
- 1 pkt. Onion, Yellow Globe
- 1 pkt. Parsley, Double Curled
- ½ lb. Peas, Dwarf Telephone
- ½ lb. Peas, Laxtonian Reselect

- 1 oz. Radish, Scarlet Globe
- 1 oz. Spinach, New Zealand
- 1 oz. Spinach, Savoy
- 1 pkt. Squash, Hubbard
- 1 pkt. Squash, Straightneck
- 1 pkt. Swiss Chard
- 1 pkt. Tomato, Bonny Best
- 1 pkt. Tomato, Livingston's Stone
- 1 pkt. Turnip, Purple Top Globe
- 1 pkt. Turnip, Rutabaga

Grey's Country Garden Collection **\$5.25**

40 Varieties, Postpaid

Will plant a garden 50 ft. by 100 ft. filled with vegetables the summer through.

- 1 lb. Dwarf Beans, Bountiful
- 1 lb. Dwarf Beans, Fordhook Lima
- 1 lb. Dwarf Beans, Sure Crop Wax
- 1 oz. Beet, Detroit Dark Red
- 1 pkt. Broccoli, Calabrese
- 1 pkt. Brussels Sprouts, Long Island
- 1 pkt. Cabbage, Danish Ballhead
- 1 pkt. Cabbage, Golden Acre
- 1 oz. Carrot, Danvers Half Long
- 1 pkt. Cauliflower, Snowball
- 1 pkt. Celery, Boston Market
- ½ lb. Corn, Golden Bantam
- ½ lb. Corn, Golden Evergreen
- 1 pkt. Cucumber, White Spine

- 1 pkt. Dandelion, Broad-leaved
- 1 pkt. Eggplant, Black Beauty
- 1 pkt. Fndive, Broad-leaved
- 1 pkt. Endive, Green Curled
- 1 pkt. Kale, Dwarf Green Curled
- 1 pkt. Kohlrabi, White Vienna
- 1 pkt. Leek, Musselburgh
- 1 pkt. Lettuce, May King
- 1 pkt. Lettuce, Romaine
- 1 pkt. Lettuce, White Boston
- 1 pkt. Melon, Bender's Surprise
- 1 pkt. Melon, Montreal Market
- 1 pkt. Watermelon, Phinney's Early

- 1 pkt. Onion, Yellow Globe
- 1 pkt. Parsley, Double Curled
- 1 lb. Peas, Dwarf Telephone
- 1 lb. Peas, Laxton's Progress
- 1 pkt. Pepper, California Wonder
- 1 oz. Radish, Scarlet Globe
- ½ oz. Spinach, New Zealand
- 1 oz. Spinach, Savoy
- 1 pkt. Squash, Des Moines
- ½ oz. Squash, Hubbard
- 1 pkt. Squash, Straightneck
- ½ oz. Turnip, Purple Top
- 1 oz. Turnip, Rutabaga

We wish to thank our many customers and friends for letters received reporting good results from our seeds. We are most grateful to all who wrote. To all of you we would suggest that it would be to us an even greater pleasure to meet more of you personally at our store, 16 South Market Street, Boston, where all will be cordially welcomed. Again we thank our many friends for their loyal support to us in the past. We appreciate your business. May we again be privileged to serve you.

THOMAS J. GREY COMPANY

A Vegetable Garden is a Good Investment—Plant a Garden!

New and Choice Vegetable Seeds of Recent Introduction ~

NOTICE: We wish to call your special attention to the fact that on this page we have listed from our general list certain novelties, also some of the All-America winner varieties of Vegetable Seed. We recommend that you include a few of these varieties in your spring seed order. All prices subject to change without notice.

Beans

COMMODORE. All-America Selections Silver Medal. Resembles Kentucky Wonder except that it is a true bush or dwarf Bean. The pods are 8 to 10 inches long, nearly straight, of excellent quality, stringless. A medium early variety. $\frac{1}{2}$ lb. 25c, lb. 40c, 2 lbs. 75c.

THE PRINCE (Sutton's). A first early variety producing a heavy crop of long, meaty pods, often measuring from 11 to 12 in. in length. Absolutely stringless and of excellent flavor. Pkt. 35c, lb. \$1.50, 2 lbs. \$2.50.

Beets

EARLY WONDER. It is an ideal all-season Beet, for while it grows a nice size it retains its tender quality throughout the season. Pkt. 10c, oz. 20c, $\frac{1}{4}$ lb. 50c.

CROSBY'S EGYPTIAN SELECTED (Arlington Strain). One of the earliest dark-leaved varieties; fine quality. Pkt. 15c, oz. 50c, $\frac{1}{4}$ lb. \$1.50, lb. \$4.00.

Cabbage

DANISH BALLHEAD. A Winter Cabbage. Extra hard-headed, of fine quality. Pkt. 10c, oz. 60c.

THE GOLDEN ACRE. A new Cabbage, head measuring 9 in. in diameter; 10 days earlier than Copenhagen Market and more compact. Pkt. 10c, oz. 60c.

Carrots

DANVERS HALF-LONG IMPROVED. Special strain. Grown for us by a leading Carrot specialist. Pkt. 15c, oz. 50c, $\frac{1}{4}$ lb. \$1.50.

IMPERATOR. All-America Selections Silver Medal. The roots average about 8 inches long, the flesh is of a rich orange color, fine grained, tender, and of fine quality. Pkt. 10c, oz. 35c, lb. \$1.00.

Cauliflower

EARLY SNOWBALL, Grey's Selected. Produces fine-grained snow-white heads; the standard of excellence in Cauliflower. Pkt. 25c, oz. \$5.00.

Celery

UTAH. A fine green variety. The stalks are large, solid, crisp, and of excellent nutty flavor. Blanches perfectly white. Pkt. 25c, oz. \$1.50.

Sweet Corn

GOLDEN CROSS BANTAM. Ears 7 to 8 inches long, 10 to 14-rowed. Slightly lighter yellow than Golden Bantam. Sweet and of fine flavor. Pkt. 25c, lb. 60c, 2 lbs. \$1.00.

GREY'S MINIATURE WHITE CORN. This extra early variety requires very little garden space, and may be grown successfully in the greenhouse. Of fine quality and very sweet. Supply limited. Pkt. 30c, $\frac{1}{4}$ lb. 55c, lb. \$1.75.

Cucumber

GREY'S A-1. The fruits will average 12 to 14 inches in length by $2\frac{1}{2}$ inches in diameter and are very symmetrical; the color a very dark green. Pkt. 25c, oz. \$1.00.

STRAIGHT EIGHT. All-America Selections Gold Medal. An excellent variety, about 8 inches long. It is well rounded at both ends, ships well and keeps its color well. Pkt. 15c, oz. 35c, $\frac{1}{4}$ lb. \$1.00.

Eggplant

NEW HAMPSHIRE HYBRID. All-America Selections Silver Medal. An extra early variety with good sized fruits, being nearly as large as Black Beauty, which it resembles. Pkt. 15c, oz. 75c.

Endive

FULL HEART BATAVIAN (Escarolle). Forms a large, compact head which blanches to a beautiful light yellow and is of the finest quality. Pkt. 10c, oz. 50c.

Lettuce

MAY KING (Selected Strain). As a Lettuce for greenhouse forcing, this is the best; the heads form very quickly and are firm and of fine quality. Pkt. 15c, oz. 50c, $\frac{1}{4}$ lb. \$1.50.

SUTTON'S SUPREME. A fine Lettuce of the Drumhead type. Leaves prettily edged with red. Pkt. 25c.

Melons

MONTREAL MARKET. The fruits are large size, beautifully netted and deeply ribbed. Flesh light green, sweet and of exquisite flavor. Pkt. 15c, oz. 75c.

Onions

DANVERS YELLOW GLOBE (Selected Strain). The finest type of this popular variety in the market. Grown for us by an Onion specialist. Pkt. 25c, oz. \$1.00, $\frac{1}{4}$ lb. \$3.00.

Parsley

PARAMOUNT. All-America Selections Silver Medal. A fine triple-curved type. Leaves beautiful dark green, finely curled, uniform. Pkt. 15c, oz. 50c.

Peas

THE MIRACLE. An early main crop, wrinkled variety. Height, 4 feet, pod long, very deep green, well filled with Peas of rich color and exquisite flavor. A heavy cropper. $\frac{1}{2}$ lb. 20c, lb. 35c, 2 lbs. 60c.

Pepper

WINDSOR "A". All-America Selections Silver Medal. Somewhat the shape and size of Ruby King, plus the thick walls of California Wonder. It is smooth shaped, mostly three-lobed. Pkt. 15c, oz. 75c.

Spinach

SUMMER SAVOY. All-America Selections Bronze Medal. Will stand several days longer without bolting to seed than Long Standing Bloomsdale, which it resembles in appearance. Pkt. 10c, oz. 20c, $\frac{1}{4}$ lb. 50c.

Squash

CONNECTICUT STRAIGHTNECK (Lemon Color). All-America Selections Honorable Mention. It is a smaller and less warted Straightneck, early, and with a very light lemon-yellow color. Pkt. 10c, oz. 50c.

EARLY PROLIFIC STRAIGHTNECK. All-America Selections Silver Medal. Similar to Connecticut Straightneck, but slightly more warted, a little deeper yellow when young; very productive. Pkt. 10c, oz. 50c.

Tomato

MICHIGAN STATE. One of the best varieties for forcing. Fruits medium-sized. Color scarlet. Flesh thick and firm, of excellent quality. Pkt. 25c, oz. \$2.00.

PRITCHARD. (Certified). All-America Selections Gold Medal. Disease-resistant, self-topping, with large, solid, smooth, light scarlet fruits. Pkt. 25c, oz. 75c.

GENERAL LIST OF VEGETABLE SEEDS

Our vegetable seeds are of the highest standard, grown for us by specialists. Our aim is purity, quality and service. Free Delivery. We will prepay Parcel Post charges on cash orders at quoted catalogue prices on Seeds, up to two pounds, anywhere in the United States, east of the Mississippi River; for larger quantities, the purchaser pays transportation charges.

Artichoke

Large Green Globe. The best variety; heads large and scales tender and excellent. Pkt. 25c, oz. \$1.00.

Jerusalem (*Helianthus tuberosus*). Cultivated for its edible tubers. April delivery only. Tubers, qt. 40c, pk. \$2.50.

Asparagus

One ounce will produce 200 plants.

The bed should be made rich by applying a heavy dressing of manure which should be plowed or spaded in; the roots should be set in rows 3 to 4 feet apart and 18 to 24 inches apart in the rows; the crown of the root should be 4 to 6 inches below the surface of the ground.

Mary Washington. The latest improved variety. Very large shoots, early, vigorous and quite rust-resistant. Pkt. 10c, oz. 50c, ¼ lb. \$1.50.

Martha Washington. Pkt. 10c, oz. 25c, ¼ lb. 75c.

BEANS Dwarf or Bush

2 lbs. of Beans will sow 100 ft. drill, 75 lbs. to an acre.

Plant in rows 2 to 3 feet apart, dropping the beans 3 inches apart and covering 2 inches. Keep the ground free from weeds and cultivate often. All the varieties are tender and must not be planted until the soil is dry and warm.



BEFORE
PLANTING
BEANS,
INOCULATE
SEED WITH

Wax-Podded Varieties

Black Wax, Improved Prolific. Early, very tender and of good quality. ½ lb. 20c, lb. 35c, 2 lbs. 65c.

Black Wax Pencil. Pods are long, pencil-like, very tender and brittle. ½ lb. 20c, lb. 35c, 2 lbs. 65c.

Brittle Wax. The best of the round podded sorts, maturing early, and bearing long, stringless pods of excellent quality. ½ lb. 20c, lb. 35c, 2 lbs. 65c.

Davis' Kidney Wax. Plant vigorous and of compact, upright growth, with pods extra long, straight, oval. ½ lb. 20c, lb. 35c, 2 lbs. 65c.

Golden Wax. The standard variety for general use; pods long, broad and flat, very fleshy and of fine quality. Vines erect, hardy and productive. ½ lb. 20c, lb. 35c, 2 lbs. 65c.

Round Pod Kidney Wax. The pods are long, straight and extremely handsome. It is an exceedingly heavy bearer. ½ lb. 20c, lb. 35c, 2 lbs. 65c.

Sure Crop Stringless Wax. A valuable new variety of dwarf wax Beans, very productive, rustproof, and will stand a longer season of damp, wet weather than any other wax Bean. ½ lb. 20c, lb. 35c, 2 lbs. 65c.

Wardwell's Kidney Wax. Very long, straight, tender pods. Vines large, vigorous and productive. ½ lb. 20c, lb. 35c, 2 lbs. 65c.

Webber Wax or "Cracker Jack." A high quality, flat podded, stringless variety. Pods 6 to 6½ in. long, quite broad and uniformly curved, fleshy, stringless and brittle, with little fibre. ½ lb. 20c, lb. 35c, 2 lbs. 65c.

Green-Podded Varieties

Abundance. An extra early variety, producing a heavy crop of long, stringless pods; excellent flavor. Lb. 50c, 2 lbs. 90c.

Agrow Valentine. An extremely early entirely stringless Bean. Pods 6½ to 7 in. long and of excellent flavor. ½ lb. 25c, lb. 40c, 2 lbs. 75c.

Bountiful. Extra early, very prolific and long bearing, flat green pods, tender and stringless. ½ lb. 20c, lb. 35c, 2 lbs. 65c.

Broad Windsor (Sutton's White). English variety, very hardy. Lb. 50c; 2 lbs. 90c.

Commodore. All-America Selections Silver Medal. Resembles Kentucky Wonder except that it is a true bush or dwarf Bean. The pods are 8 to 10 inches long, nearly straight, of excellent quality, stringless. A medium early variety. Pkt. 25c, lb. 40c, 2 lbs. 75c.

Emperor of Russia. Extremely prolific. Pods long, slender and meaty. Medium early. French grown. Lb. 50c, 2 lbs. 90c.

Giant Stringless Green Pod. Color deep green, very long, round, fleshy pods; very prolific and entirely stringless. ½ lb. 20c, lb. 35c, 2 lbs. 65c.

Horticultural French Dwarf. An improved form of Dwarf Horticultural, producing long pods, beautifully splashed with bright crimson, heavy cropper. ½ lb. 20c, lb. 35c, 2 lbs. 65c.

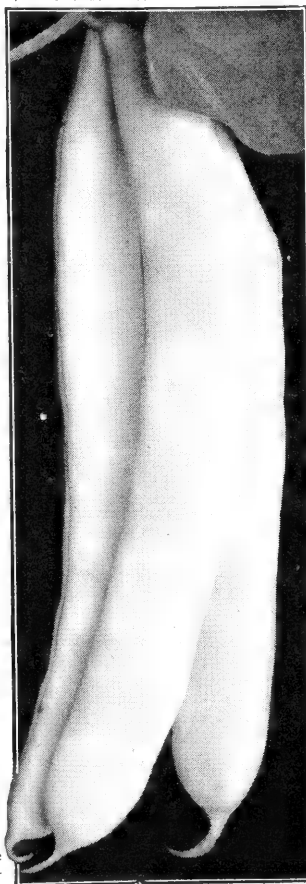

Webber Wax Beans

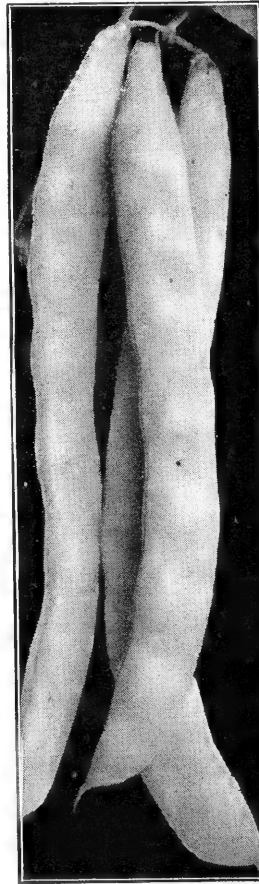

Bountiful Beans

BEANS, Green-podded Varieties—Continued

- Low's Champion.** One of the best for snap or shell, with stringless, large, green, flat pods. $\frac{1}{2}$ lb. 20c; lb. 35c, 2 lbs. 65c.
- Masterpiece Stringless Bush.** A fine variety for exhibition and for those who demand quality. $\frac{1}{2}$ lb. 25c, lb. 40c, 2 lbs. 75c.
- Refugee, Late or 1000 to 1.** Very tender and productive; the best variety for picking. $\frac{1}{2}$ lb. 25c, lb. 40c, 2 lbs. 75c.
- Stringless Green Pod, Burpee's, Extra early, prolific, round pod and stringless.** $\frac{1}{2}$ lb. 20c, lb. 35c, 2 lbs. 65c.
- Tendergreen.** An early, round podded variety, the pods are meaty, absolutely stringless, and of excellent flavor. $\frac{1}{2}$ lb. 20c, lb. 35c, 2 lbs. 65c.
- The Prince (Sutton's).** A first early variety producing a heavy crop of long, meaty pods, often measuring from 11 to 12 in. in length. Absolutely stringless and of excellent flavor. Pkt. 35c, lb. \$1.50, 2 lbs. \$2.50.
- Wonder of France.** A valuable French variety for forcing. $\frac{1}{2}$ lb. 30c, lb. 50c, 2 lbs. 90c.



Pole Beans in Garden

Dwarf or Bush Lima

Lima Beans are very susceptible to cold and wet, and apt to rot in the ground, and should not be planted until all danger from frost is over and the soil is dry and warm.

- Lima, Burpee's Improved Bush.** Best dwarf Lima Beans, large and delicious. $\frac{1}{2}$ lb. 25c, lb. 40c, 2 lbs. 75c.
- Lima, Dreer's Bush.** Possesses all the good qualities of the Dreer's Pole Lima. $\frac{1}{2}$ lb. 25c, lb. 40c, 2 lbs. 75c.
- Lima, Fordhook Bush.** Pods and beans twice the size of Dreer's Lima, and earlier. $\frac{1}{2}$ lb. 25c, lb. 40c, 2 lbs. 75c.
- Lima, Henderson's Bush.** Pods and beans small; of excellent quality as a shell Bean. $\frac{1}{2}$ lb. 20c, lb. 35c, 2 lbs. 65c.
- Lima, McCrear's Bush Lima.** A very early variety of excellent quality and flavor. The vines are strong and wilt resisting. We strongly recommend a trial of this splendid variety. $\frac{1}{2}$ lb. 25c, lb. 40c, 2 lbs. 75c.

Dwarf Shell Beans

- Improved Yellow Eye.** One of the best sorts for baking. $\frac{1}{2}$ lb. 15c, lb. 25c, 2 lbs. 45c.
- Vermont Pea Bean.** A most productive small white baking variety, of superior quality. $\frac{1}{2}$ lb. 15c, lb. 25c, 2 lbs. 45c.
- Red Kidney.** Popular baking Bean. $\frac{1}{2}$ lb. 15c, lb. 25c, 2 lbs. 45c.

BEANS, Pole or Running

■ lbs. will plant 100 hills, ■ lbs. to the acre.

All under this head require poles ■ to 8 feet long and should not be planted until the ground is warm, as they are more tender than the dwarf varieties. Plant about the middle of May if the season is suitable.

- Burger's Stringless Green-Pod.** The pods, borne in clusters, average 6 to 8 inches in length. $\frac{1}{2}$ lb. 20c, lb. 30c, 2 lbs. 55c.
- Improved Kentucky Wonder.** Excellent, very productive. Pods ■ silvery-green color of large size and entirely stringless. $\frac{1}{2}$ lb. 20c, lb. 30c, 2 lbs. 55c.
- Italian Pole.** A green-podded pole string Bean, absolutely stringless, unsurpassed for ■ string or shelled Bean. $\frac{1}{2}$ lb. 25c, lb. 40c, 2 lbs. 75c.
- Kentucky Wonder Wax.** A Wax Pole Bean with all the good qualities of old Kentucky Wonder. $\frac{1}{2}$ lb. 20c, lb. 35c, 2 lbs. 65c.

- King Horticultural.** Early and productive. A greatly improved Pole Horticultural. $\frac{1}{2}$ lb. 20c, lb. 35c, 2 lbs. 65c.
- Runner, Scarlet.** Bright scarlet flowers. Used both as ■ string and shelled Bean. $\frac{1}{2}$ lb. 30c, lb. 50c, 2 lbs. 90c.
- Runner, White.** Very effective planted with the Scarlet Runner. $\frac{1}{2}$ lb. 30c, lb. 50c, 2 lbs. 90c.

Pole Lima Beans

Lima Beans are very susceptible to cold and wet, and apt to rot in the ground, and should not be planted until all danger of frost is over, and the soil is dry and warm.

- Lima, Carpinteria.** A large-seeded variety of vigorous growth. Pods large and well filled with Beans of excellent flavor. $\frac{1}{2}$ lb. 25c, lb. 40c, 2 lbs. 75c.
- Lima, Dreer's Improved.** An improved Lima, being much thicker than the old Lima and superior in quality. $\frac{1}{2}$ lb. 25c, lb. 40c, 2 lbs. 75c.
- Lima, Early Leviathan.** A very early variety; produces pods in clusters. A splendid variety where the season is short. $\frac{1}{2}$ lb. 25c, lb. 40c, 2 lbs. 75c.
- Lima, Hopi.** Has the flavor of the large lima and can be used as ■ green bean or dry. The flavor is delicious. $\frac{1}{2}$ lb. 25c, lb. 40c, 2 lbs. 75c.
- Lima, King of the Garden.** Early and extremely prolific with large pods bearing five to six beans. $\frac{1}{2}$ lb. 25c, lb. 40c, 2 lbs. 75c.
- Lima, Siebert Early.** An immense yielder and excellent quality. $\frac{1}{2}$ lb. 25c, lb. 40c, 2 lbs. 75c.
- Lima, Sieva or Small.** A popular small-seeded variety. $\frac{1}{2}$ lb. 20c, lb. 35c, 2 lbs. 65c.

CEDAR BEAN POLES, ■ to 10 ft. long, per doz. \$1.80,
per 100 \$14.00.

Broccoli

One ounce will produce about 3500 plants.

The seed should be sown early in the spring and the plants transplanted into rows ■ feet apart, with 2 feet between the plants.

- Early Green Calabrese.** A distinct variety forming good sized green heads; this vegetable resembles the Cauliflower with combined Cauliflower and Asparagus flavor. Seed imported. Pkt. 25c, oz. \$1.00, $\frac{1}{4}$ lb. \$3.50.
- Rapa.** Produces numerous small green heads which are cut and bunched the same as sprouting Broccoli. Very early. Pkt., 10c, oz. 25c, $\frac{1}{4}$ lb. 75c.
- White Cape.** Heads compact, good size, and of ■ creamy white. Pkt. 10c, oz. 75c.

Beets

One ounce will sow 50 feet of drill; 5 to 10 lbs. an acre.

Sow in drills from April until July, 16 inches apart and about 1 inch deep; thin the plants about 3 inches apart. The Turnip rooted are the best.

Crosby's Egyptian Selected (Arlington Strain), One of the earliest dark-leaved varieties; fine quality. Pkt. 15c, oz. 50c ¼ lb. \$1.50, lb. \$4.00.

Crosby's Egyptian, One of the earliest dark red varieties; fine quality. Very popular among market gardeners. Pkt. 10c, oz. 20c, ¼ lb. 50c.

Detroit Dark Red, Round and smooth, deep red, very tender. Pkt. 10c, oz. 20c, ¼ lb. 50c.

Early Wonder, The most perfect model of an extra early round Beet. The flesh is deep blood-red crimson. It is an ideal all season Beet. Pkt. 10c, oz. 20c, ¼ lb. 50c, lb. \$1.50.

Grey's Blood Turnip, One of the very best strains for market gardeners; small top, round, handsome and very dark red. Pkt. 15c, oz. 50c, ¼ lb. \$1.50, lb. \$4.00.

Perpetual, or Spinach Beet, This variety will give a constant supply of Spinach throughout the season. Pkt. 10c, oz. 20c, ¼ lb. 60c.

Swiss Chard, The leaves are used as Spinach, and the midrib of the leaf, cooked and served up like Asparagus, is delicious. Pkt. 10c, oz. 20c, ¼ lb. 60c.

Swiss Chard, Fordhook Giant, A superior variety of Chard with dark green, crumpled leaves. Pkt. 10c, oz. 20c, ¼ lb. 60c.

Swiss Chard, Lucullus, A tall-growing variety, crinkled leaves, tender and of fine flavor. Pkt. 10c, oz. 20c, ¼ lb. 60c.

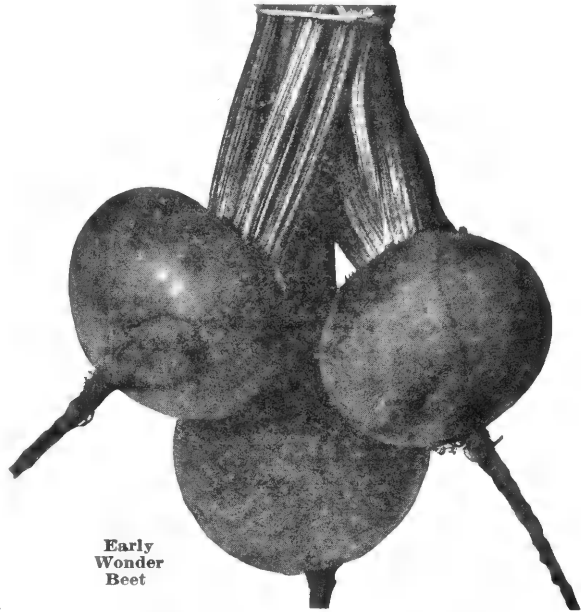

Early
Wonder
Beet

Sugar Beet and Mangel Wurzel

Sow in April or May, using 5 to 10 lbs. of seed to the acre. **Grey's Prize Long Red Mangel Wurzel**, The most largely grown of the Mangels; roots attain an enormous size, producing 30 to 50 tons to the acre; quality superior, the best for deep soil. Oz. 20c, ¼ lb. 60c, lb. \$1.50.

Golden Tankard Mangel Wurzel, The flesh is bright golden yellow; very large, and will produce more Mangels to the acre than any other variety; excellent for feeding stock. Oz. 10c, ¼ lb. 25c, lb. 75c.

Lane's Improved Sugar Beet, Large, hardy, productive and excellent quality. Oz. 15c, ¼ lb. 40c, lb. \$1.00.

Norbition Giant Mangel Wurzel, Long red. A valuable variety for deep soil; very productive. Oz. 15c, ¼ lb. 40c, lb. \$1.00.



Grey's Prize Long Red
Mangel Wurzel

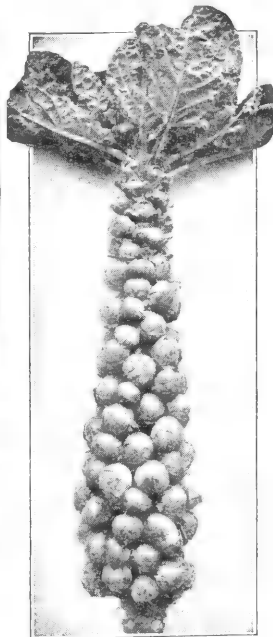

Brussels Sprouts

Brussels Sprouts

One ounce will produce 2000 plants.

Cultivated for the small heads that grow from the main stem; these small heads are firm and compact, like little Cabbages, and are considered a great delicacy by many people. Cultivate the same as Cabbage or Cauliflower.

Dobbie's Exhibition, Grows tall; is of good quality and very productive. Pkt. 25c, oz. \$1.25.

Improved Dwarf French, Tender and of fine flavor. Pkt. 10c, oz. 50c.

Long Island Improved, Very compact heads, productive. Pkt. 25c, oz. 50c.

NOTICE. We are pleased at all times to quote prices on special grass mixtures, and for those wishing mixtures of their own formula, we will either ship the varieties separate, or mix them to the customer's instruction. See Pages 63-64-65.

Cabbage

One ounce produces about 3000 plants.

For early use a sowing may be made in the hotbed in February or March, and for winter use seed should be sown in the open ground in May or June. When the plants are 5 or 6 inches in height, transplant into rows 3 to 3½ feet apart, setting the plants from 2 to 3 feet apart in the rows, according to the variety.

American Improved Savoy. The favorite curled Savoy Cabbage of finest quality, and an excellent keeper. Pkt. 10c, oz. 40c, ¼ lb. \$1.35.

Baby Head Cabbage. The heads are small and of fine quality. We recommend Baby Head Cabbage for greenhouse growing and where space is limited. The seed we offer is grown for us in Denmark. Pkt. 15c, oz. 75c.

Copenhagen Market. As early as Charleston Wakefield. Very solid. Excellent market sort. Pkt. 10c, oz. 60c.

Danish Ballhead. A winter Cabbage. Extra hard-headed, of fine quality. Pkt. 10c, oz. 60c.

Early Summer, Henderson's. A few days later than Wakefield, rather larger and more globe-shaped. Pkt. 10c, oz. 35c, ¼ lb. \$1.25.

Early Jersey Wakefield. One of the most popular early pointed varieties; good grower. Pkt. 10c, oz. 35c, ¼ lb. \$1.25.

Early Wonder Red. The earliest of all red Cabbages. The heads are large, solid and handsome, of delicious flavor, color dark red. Pkt. 10c, oz. 75c.

Globe Curled Savoy. A variety with finely curled leaves and of delicate flavor; used for fall crop or for winter. Pkt. 10c, oz. 75c, ¼ lb. \$2.50.

Golden Acre. A new Cabbage, head measuring 9 in. in diameter; 10 days earlier than Copenhagen Market and more compact. Pkt. 10c, oz. 60c.

Penn State Ballhead. A large somewhat flattened form of the Ballhead, producing probably the largest tonnage per acre of any known variety. This is one of the best winter varieties. Pkt. 15c, oz. 75c, ¼ lb. \$2.50.



Copenhagen Market Cabbage

Red Dutch Pickling. Used extensively for pickling; tender, medium size. Pkt. 10c; oz. 35c; ¼ lb. \$1.25.

Stone Mason. Select strain. One of the oldest and best known varieties; large size; drumhead; grown principally as a late Cabbage, and for winter keeping. Pkt. 10c, oz. 50c, ¼ lb. \$1.50.



Chinese Cabbage, Chihli

Chinese or Celery Cabbage

This is a native of China and distinct from other cabbage; it grows like Romaine lettuce and makes an elegant salad, with a delightful flavor. Seed should be sown the latter part of July, in rows 2½ feet apart and the plants thinned out to 18 to 20 inches in the rows; if sown too early the heat causes it to run to seed.

CHIH LI. For fine quality, earliness and sure heading. This variety is unsurpassed. Heads grow 18 to 20 inches tall, 3½ to 4 inches thick, tapered near tip. Very firm, well blanched, crisp, tender and sweet. Pkt. 10c, oz. 40c, ¼ lb. \$1.25.

PE TSAI. This resembles in appearance and growth a head of Romaine lettuce; heads are firm; grows somewhat taller than Wong Bok, but not as thick through. Pkt. 10c, oz. 40c, ¼ lb. \$1.25.

WONG BOK. Does not grow quite as tall as Pe Tsai, but is thicker through; heads are elongated, self-folding and require no blanching. Pkt. 10c, oz. 40c, ¼ lb. \$1.25.

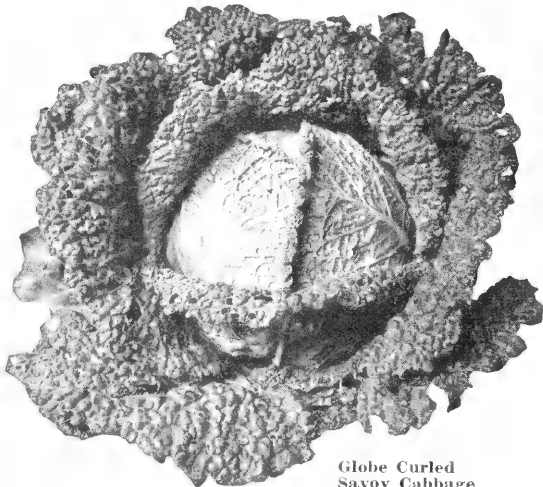

Globe Curled Savoy Cabbage

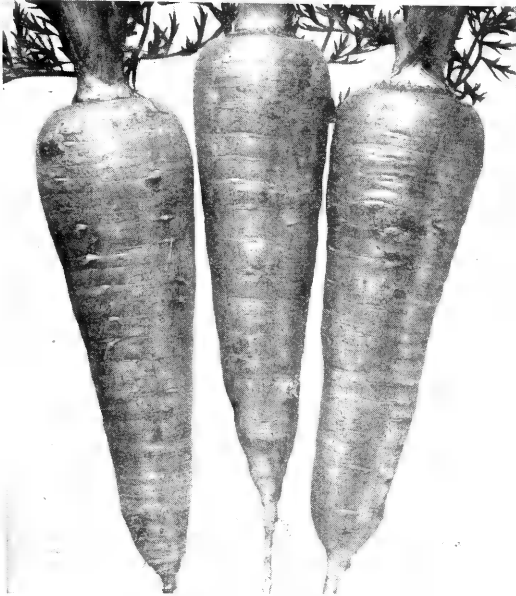

Danvers Half-Long Improved Special Strain Carrots

Carrot

One ounce will sow 100 feet of drill, 3 lbs. required for one acre.

For an early crop, sow as soon as danger from frost is over, in rows 1 foot apart; when 2 inches high, thin out to stand 2 inches apart in the row. For a late crop, sow in May or June. The long sorts should be sown early; the half-long and round sorts can be sown later.

We furnish packets of all varieties of Carrots at 10c each, postpaid, except where noted.

Amsterdam Forcing (Coreless). the roots are ■ bright salmon-red color, blunt ended and small tap-root, and extremely fine grained. Pkt. 10c, oz. 25c, ¼ lb. 75c.

Chantenay, Morse's Red Cored. Medium early. An excellent table Carrot. Pkt. 10c, oz. 35c, ¼ lb. \$1.00.

Danvers Half-Long. The best variety for general crop; is of rich color and a good keeper. Pkt. 10c, oz. 35c, ¼ lb. \$1.00.

Danvers Half-long Improved, Special Strain. Grown for us by ■ leading Carrot specialist. Pkt. 15c, oz. 50c, ¼ lb. \$1.50.

Earliest French Forcing. The earliest variety and good for forcing under glass. Pkt. 10c, oz. 35c, ¼ lb. \$1.00.

Early Scarlet Horn. A medium sized root, half long, of fine color. Pkt. 10c, oz. 35c, ¼ lb. \$1.00.

Guerande or Oxheart. Intermediate length, 3 to 5 in. in diameter; fine quality. Pkt. 10c, oz. 35c, ¼ lb. \$1.00.

Hutchinson Strain. A very fine Carrot, 8 to 9 in. long, nearly the same size the whole length and stump-rooted. Pkt. 10c, oz. 40c, ¼ lb. \$1.25.

Imperator. All-America Selections Silver Medal. The roots average about 8 inches long, the flesh is of a rich orange color, fine grained, tender, and of fine quality. Pkt. 10c, oz. 35c, ¼ lb. \$1.00.

Improved Long Orange. Excellent for stock or table use; roots deep orange. 12 to 15 in. Pkt. 10c, oz. 35c, ¼ lb. \$1.00.

James' Intermediate. The best intermediate variety; small core and of fine flavor. Pkt. 10c, oz. 35c, ¼ lb. \$1.00.

Cauliflower

One ounce will produce 3000 plants.

The Cauliflower, like the Cabbage, requires a deep, rich soil. Set the plants in rows and cultivate the same as Cabbage.

Early Dwarf Danish. A choice strain that comes to maturity very evenly; a favorite for first crop with many growers. Pkt. 25c, oz. \$5.00.

Earliest Dwarf Erfurt. One of the earliest varieties; very dwarf, with large, white, compact heads of finest quality. Excellent for forcing. Pkt. 25c, oz. \$5.00.

Early Snowball, Grey's Selected. Produces fine-grained, snow-white heads; the standard of excellence in Cauliflower. Pkt. 25c, oz. \$5.00.

Veitch's Autumn Giant. Heads very large, white and compact; well protected by foliage; will remain suitable for use a long time. Pkt. 10c, oz. \$1.00, ¼ lb. \$2.50.

Cardoon

Large Smooth. A tender and richly flavored variety which blanches easily. Pkt. 10c, oz. 50c, ¼ lb. \$1.50.

Chervil

Curled Chervil. Cultivated like Parsley. The young leaves for flavoring soups and salads and are also used for garnishing. Pkt. 10c, oz. 50c.

Chicory

Large-rooted Magdeburg. Roots when dried and roasted are used as a substitute for coffee. Pkt. 10c, oz. 35c, ¼ lb. \$1.10.

Witloof, or French Endive. This grows in a solid oblong head and blanches ivory white. One of the choicest of all winter salads. Pkt. 10c, oz. 40c, ¼ lb. \$1.25.

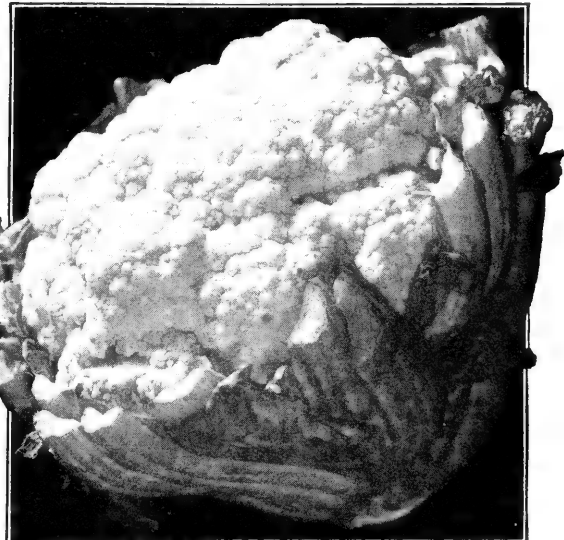

Grey's Selected Early Snowball Cauliflower

Celery

One ounce will produce about 4000 plants.

Sow the seeds in March or April in ■ hotbed or cold-frame. As soon as the plants are 3 inches high, transplant into a prepared border, setting them 4 inches apart. When grown ■ inches, and fine stocky plants, set in richly manured deep soil, in rows 3½ feet apart and about 9 inches from plant to plant.

Boston Market. (Selected Strain.) The finest flavored variety in cultivation; solid, crisp and of excellent nutty flavor; dwarf, branching habit; blanches perfectly white; ■ splendid keeper. Pkt. 25c, oz. \$1.00.

Celeriac or Turnip-rooted Celery, Giant Smooth Prague. Turnip-shaped roots; cultivated ■ Celery. Pkt. 10c, oz. 50c, ¼ lb. \$1.50.

Easy Blanching. The plants make a rapid and vigorous growth, producing rather thick, solid stalks of excellent quality and rich, nutty flavor. Pkt. 15c, oz. \$1.50.

Giant Pascal (Arlington Strain). A valuable variety for both second early and winter use. Pkt. 10c, oz. 75c, ¼ lb. \$2.50.

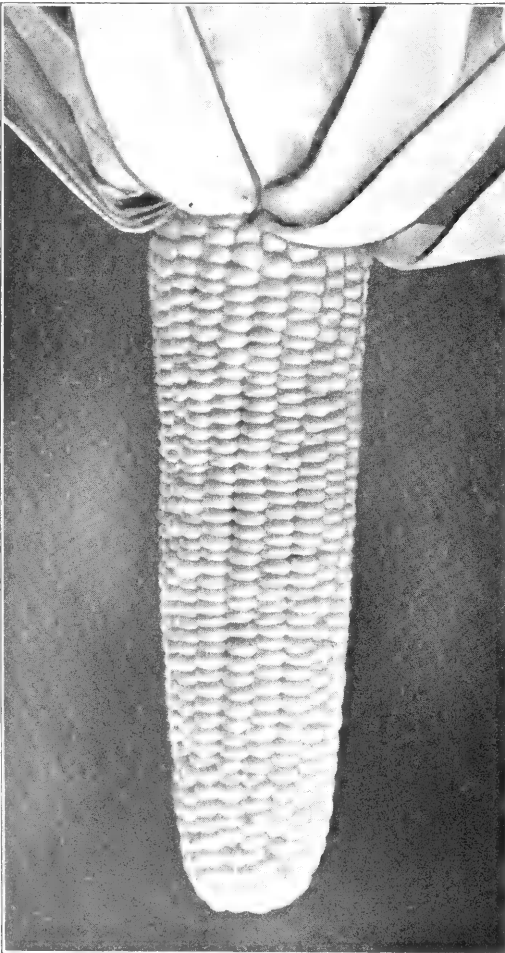

Stowell's Evergreen, Platt's Strain

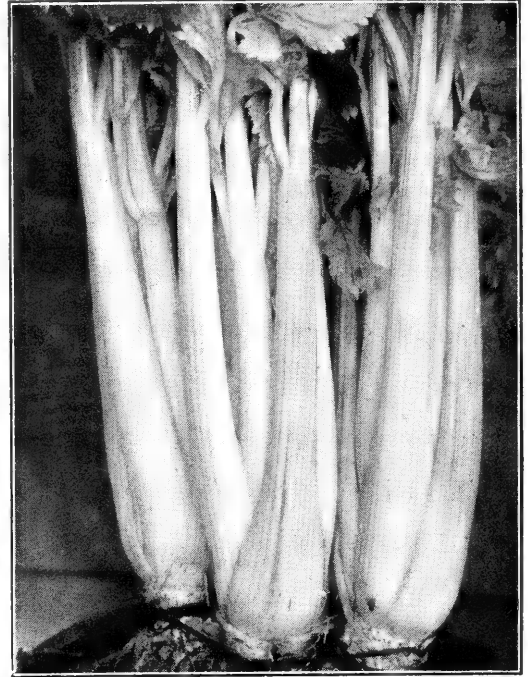

Utah Celery

Golden Plume. The plants are of strong growth and produce thick and heavy stalks of excellent crisp and nutty flavor. Pkt. 10c, oz. \$1.00, ¼ lb. \$3.50.

Newark Market. Green, easy blanching variety; stalks large, solid, crisp and tender; ■ good keeper and will blanch in cold storage. Pkt. 15c, oz. \$1.50.

Paris Golden. The plant blanches quickly to ■ beautiful golden yellow; the stalks are brittle and have a fine, nutty flavor. Pkt. 10c, oz. \$1.00, ¼ lb. \$3.50.

Utah. A fine green variety. The stalks are large, solid, crisp, and of excellent nutty flavor. Blanches perfectly white. Pkt. 25c, oz. \$1.50.

White Plume. Ornamental; stalks and portions of leaves are naturally white. Pkt. 10c, oz. 50c, ¼ lb. \$1.75.

Winter Queen. This is one of the finest dwarf winter Celeries. Pkt. 10c, oz. 50c.

CORN, Sweet or Sugar

One pound of corn will plant 100 feet of drill or 150 hills; 12 lbs. to the ■■■■.

Free Delivery. We will prepay Parcel Post charges on cash orders at quoted catalogue prices on Corn, up to two pounds, anywhere in the United States, east of the Mississippi River; for larger quantities, the purchaser pays transportation charges.

Plant in hills ■ feet apart each way, dropping five or six kernels in each hill, or plant in rows ■ to 4 feet apart, and thin the plants out to ■ or ■ inches in row.

Bantam Evergreen Corn. A yellow variety maturing about 10 days after the Golden Bantam and ■ week earlier than the Stowell's Evergreen white. It has ■■■ three times the size of Golden Bantam. ½ lb. 20c, lb. 35c, 2 lbs. 60c.

Black Mexican. A medium early variety, very sweet, tender, and of delicious flavor. ½ lb. 20c, lb. 35c, 2 lbs. 60c.

Sweet Corn—Continued

Country Gentleman. Cob small, with deep kernels of pearly whiteness; quality delicious. ½ lb. 20c, lb. 30c, 2 lbs. 50c.

Early Crosby. A popular variety; early, good size; and one of the best. ½ lb. 25c, lb. 40c, 2 lbs. 70c.

Early Golden Improved. Ears large, 10- to 12-rowed, rich golden yellow color. ½ lb. 20c, lb. 30c, 2 lbs. 50c.

Golden Bantam, Early, sweet and tender. Smaller than Early Golden; 8-rowed. A favorite variety. ½ lb. 20c, lb. 30c, 2 lbs. 50c.

Golden Cross Bantam. Ears 7 to 8 inches long, 10 to 14-rowed. Sweet and of fine flavor. ½ lb. 35c, lb. 60c, 2 lbs. \$1.00.

Golden Early Market. One of the best extra early varieties; ears 8- to 12-rowed, tender, sweet, and of good flavor. ½ lb. 20c, lb. 30c, 2 lbs. 50c.

Golden Giant. With its 12- to 16-rowed ears and deep golden yellow kernels it is the most desirable yellow sweet corn yet introduced. ½ lb. 20c, lb. 35c, 2 lbs. 60c.

Golden Sunshine. The earliest of the Golden Bantam type, ears 6½ inches long, containing 12 rows of broad, yellow, sweet grains. ½ lb. 20c, lb. 30c, 2 lbs. 50c.

Grey's Miniature White Corn. Grows about 30 inches high; ears 3 to 4 inches long, of fine quality and very sweet. Supply limited. Pkt. 30c, ¼ lb. 55c, lb. \$1.75.

Potter's Excelsior or Squantum. Medium late, 12-rowed ears of excellent quality. ½ lb. 20c, lb. 30c, 2 lbs. 50c.

Stowell's Evergreen. This Corn specially adapted for New England. Ears 8 to 9 inches long, 16- to 18-rowed, with a very deep sweet grain of the finest quality. ½ lb. 20c, lb. 30c, 2 lbs. 50c.

Tendergold. A hybrid wilt resisting sweet corn. The ears average 8 inches in length and are 12-rowed. Quality of the finest, very tender and sweet. ½ lb. 35c, lb. 60c, 2 lbs. \$1.00.

Whipple's Yellow Sweet Corn. The ears are very large, 8 to 10 inches long, having 14 to 18 rows of deep kernels. ½ lb. 20c, lb. 30c, 2 lbs. 50c.

Corn, Field and Fodder. See page 66.

Cucumber

One ounce will plant about 50 hills, 2 to 3 pounds an acre.

For very early use seed may be started in heat and the plants set out in May. For main crop, plant in hills 4 feet apart, in the end of May. Make the hills rich with well rotted manure. Leave four strong plants to each hill.

Arlington White Spine. One of the most perfect in shape, size, color and quality, and is very brittle and crisp. Pkt. 10c, oz. 25c, ¼ lb. 75c.

Boston Pickling. The best pickling variety yet introduced; very productive. Pkt. 10c, oz. 25c, ¼ lb. 75c.

Davis Perfect. Highly recommended; dark, rich green in color, crisp and tender. Pkt. 10c, oz. 25c, ¼ lb. 75c.

Fordhook Famous. Fruit long, thick, and tapering at both ends, crisp and solid; a fine slicing sort; color light green. Pkt. 10c, oz. 25c, ¼ lb. 75c.

Grey's A-1. The fruits will average 12 to 14 inches in length by 2½ inches in diameter and are very symmetrical; the color a very dark green. Pkt. 25c, oz. \$1.00.

Japanese Climbing. Fruit about 10 inches long; thick and of fine flavor. Pkt. 10c, oz. 25c, ¼ lb. 75c.

Longfellow. The fruit is 10 to 12 inches long, 2½ inches in diameter and of the highest quality. Pkt. 10c, oz. 40c.

Straight-8. All-America Selections Gold Medal. An excellent variety about 8 inches long. It is well rounded at both ends, ships well and keeps its color well. Pkt. 15c, oz. 35c, ¼ lb. \$1.00.

West India Gherkin. Used for pickling purposes; a small, oval-shape variety; has the appearance of a burr. Pkt. 10c, oz. 25c, ¼ lb. 75c.

Woodruff's Hybrid. One of the best of the White Spines. Grows 8 to 10 inches long and stays green a long time. Pkt. 10c, oz. 25c, ¼ lb. 75c.

ENGLISH FRAME VARIETIES

The following are excellent varieties for growing in forcing houses.

Every-day (Sutton's). Fruits of good length, color deep green, almost smooth. Pkt. 75c.

King George (Sutton's). Fruits are unusually handsome and perfect in form. Pkt. 75c.

Rochford's Market. A well-known variety; heavy cropper. Pkt. 75c.

Telegraph Improved (Sutton's). Fruit handsome with very small neck; very prolific. Pkt. 75c.

Tender and True. A well known variety, heavy cropper. Pkt. 75c.

Chives

Seed. Pkt. 25c, oz. \$1.00.

Roots. 30c per clump, 12 clumps \$3.00. By mail, add 10c extra for each clump.

SEMESAN. Place a little Semesan with seeds in a jar and shake vigorously; bacteria and fungus spores adhering to seeds will be killed. ½ ozs. 35c, lb. \$2.25, 5 lbs. \$10.00.

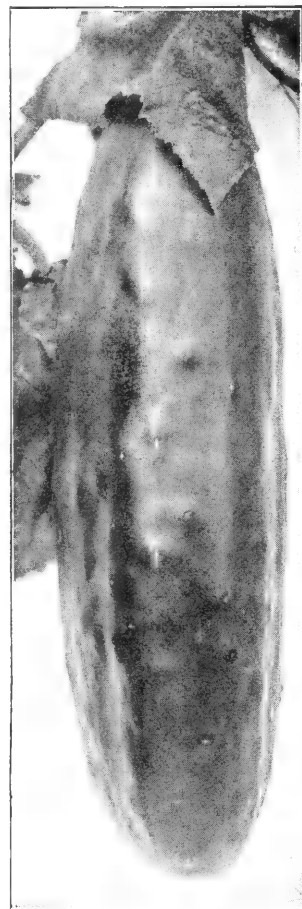

Arlington White Spine
Cucumber

All prices subject to change without notice.

Collards

Georgia, Southern, or Creole. This vegetable develops a loose-leaved head. It grows 2 or 3 feet high and produces large, light green leaves on rather long stems. A frost, if not too severe, will improve the crop. Pkt. 10c, oz. 25c, ¼ lb. 75c.

Corn Salad or Fetticus

One ounce will sow 100 feet of drill.

This excellent salad may be had the year round. Sow in September, in drills 8 inches apart, covering the seeds lightly to protect from frost by a light covering of hay or litter. The seed may also be sown in spring.

Large-seeded. The most popular variety grown. Pkt. 10c, oz. 25c, ¼ lb. 75c.

Cress or Pepper Grass

One ounce will sow 100 feet of drill.

A popular salad, which should be sown early in spring—very thickly in shallow drills—and at short intervals, for succession, as it soon runs to seed.

Extra Curled. The best variety grown; leaves are beautifully cut and curled; highly prized for garnishing. Pkt. 10c, oz. 20c, ¼ lb. 40c.

Upland Cress. Has highly prized flavor of Water Cress. Green all year; ready for use before any other salad. Pkt. 10c, oz. 25c, ¼ lb. 75c.

Water. This wholesome salad may be grown in any moist situation. Plants should be set not less than a foot apart. The Cress is fit for gathering the second year. Pkt. 10c, oz. 75c, ¼ lb. \$2.25, lb. \$7.00.

Kohlrabi

One ounce will sow 200 feet of drill.

The seed may be sown in June in rows 18 inches apart, and the plants thinned out to 8 or 10 inches.

Purple Vienna. Similar to the following, except in color. Pkt. 10c, oz. 35c, ¼ lb. \$1.25.

White Vienna. The earliest and best table or market variety. Pkt. 10c, oz. 50c, ¼ lb. \$1.50.

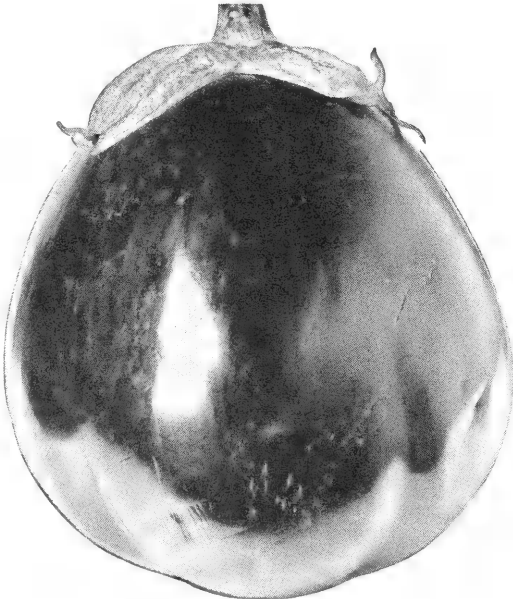

Black Beauty Eggplant

Dandelion

One ounce will sow 200 feet of drill; 2 lbs. will sow an acre

Sow seed in May or June, in drills ½ inch deep and 15 inches apart. Thin the plants to stand 4 inches apart, cultivate during the summer to keep down weeds. Dandelion may be blanched like Endive for salad purposes.

American Improved. The finest variety, leaves very numerous, thick in texture and blanch rapidly. Pkt. 25c, oz. \$1.00, ¼ lb. \$3.00.

French Thick Leaf. Unsurpassed in thickness of leaf and deep green color. Pkt. 10c, oz. 50c, ¼ lb. \$1.50.

Eggplant

One ounce will produce about 1500 plants.

Sow in hotbeds very early in spring, and transplant when two inches high into a second bed or into small pots. If that is not done, thin to 4 inches apart. Do not plant out till the weather becomes perfectly settled and warm. Keep plants watered for a few days if the sun is hot when put out. Set out plants 3 feet by 2.

Black Beauty. Very early and as large as New York Improved. Rich purplish black color. Pkt. 15c, oz. 50c.

Black Pekin. Fruit globular, almost black in color, fine grained and delicately flavored. Pkt. 15c, oz. 50c.

Early Long Purple. A very early, hardy and productive variety of good quality. Pkt. 15c, oz. 50c.

New York Improved. A leading market variety; fruit large, oval, very productive. Pkt. 15c, oz. 50c.

New Hampshire Hybrid. All-America Selections Silver Medal. An extra early variety with good-sized fruits, being nearly as large as Black Beauty, which it resembles. Pkt. 15c, oz. 75c.

Endive

One ounce will sow 200 feet of drill.

A rather moist soil is preferred. Sow early in the spring in drills, 12 inches apart, and thin out the plants to 10 inches apart in the drills as soon as they are large enough to handle.

Full Heart Batavian (Escarolle). Forms a large compact head which blanches to a beautiful light yellow and is of the finest quality. Pkt. 10c, oz. 50c.

Green Curled. A very hardy dark green, closely curled variety, tender and crisp. Pkt. 10c, oz. 35c, ¼ lb. \$1.00.

Moss Curled. Beautifully curled, and when well developed resembles a tuft of moss. Pkt. 10c, oz. 35c, ¼ lb. \$1.00.

Witloof. See Chicory, page 47.

Fennel, Florence or Naples

(Finocchio di Napoli)

Sow in spring in rows 16 to 20 inches apart and thin to 5 or 6 inches apart. Water freely. Pkt. 10c, oz. 50c.

Garlic

The bulbs are set out like Onion sets, about 4 inches apart in the row, divided into "cloves" or flakes and covered 2 inches deep. Lb. 60c.

Horseradish Sets

Maliner Kren. A variety producing very large, pure white roots. Strong sets. Doz. 35c, 100 \$1.75.

Kale or Borecole

One ounce will produce about 3500 plants.

Early plants may be started in the hotbed, or the seeds may be sown in the open ground in April or May; transplant in June, into rows, and cultivate the same as Cabbage.

Dwarf Green Curled. One of the best; very hardy and improved by a moderate frost. Pkt. 10c, oz. 25c, ¼ lb. 75c.

Winter, or Siberian Greens (Sprouts). Sow in August or early in September in rows 1 foot apart. Pkt. 10c, oz. 25c, ¼ lb. 75c.

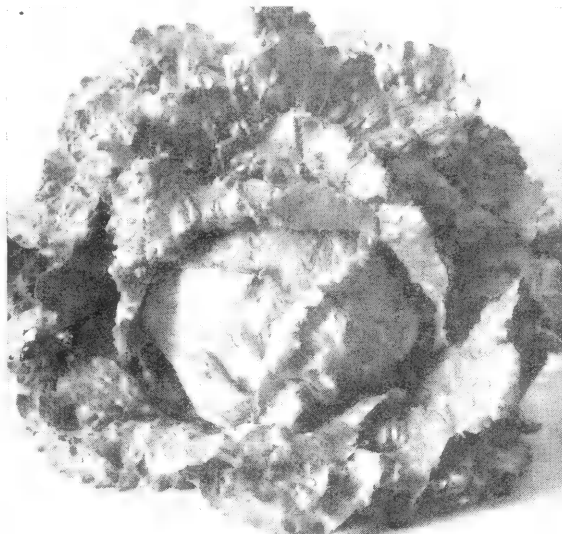

New York No. 12

LETTUCE

One ounce will produce about 3000 plants.

For early use, sow under glass in February or March, and transplant into a previously prepared hotbed; rows at least 12 inches apart, according to the varieties. Sowing may be made in the open ground as soon as all danger from frost is over; if a continuous supply is desired during season, make sowings every two or three weeks until September.

Big Boston. A most desirable variety either for forcing or open ground planting. Pkt. 10c, oz. 40c, ¼ lb. \$1.00.

Black Seeded Mammoth Butter. Produces enormous formed heads of the finest quality. Pkt. 10c, oz. 40c, ¼ lb. \$1.00.

Butterhead. A splendid large heading variety, crisp, tender, and of fine quality. Pkt. 10c, oz. 50c.

Deacon. Splendid variety; large, solid heads, tender, crisp and sweet. Pkt. 10c, oz. 40c, ¼ lb. \$1.00.

French, Unrivalled. A sure heading variety, forming large, compact heads, and slow to run to seed. Pkt. 10c, oz. 40c, ¼ lb. \$1.00.

Hanson Improved. A superior, curled heading variety of large size, sweet, tender and crisp. Pkt. 10c, oz. 40c, ¼ lb. \$1.00.

Hartford Bronzed Head. A medium sized, compact variety, leaves tinged with bronze. Is crisp, tender, and of fine flavor. Pkt. 10c, oz. 50c.

Iceberg. A solid heading large variety of excellent quality. Pkt. 10c, oz. 50c, ¼ lb. \$1.50.

May King. Grows quickly and produces globe-shaped heads which are ten to fourteen days earlier than any other, and which stand a long time before going to seed. Pkt. 10c, oz. 40c, ¼ lb. \$1.00.

May King, Selected Strain. As a Lettuce for greenhouse forcing, this is the best; heads form very quickly, are firm and of fine quality. Pkt. 15c, oz. 50c, ¼ lb. \$1.50.

Prize Head, Large. loose heads, tinged with brown. Pkt. 10c, oz. 40c, ¼ lb. \$1.00.

New York No. 12. A sure and reliable header and slow to shoot to seed. The heads are creamy white, sweet and tender, unsurpassed for spring and summer planting. Pkt. 10c, oz. 50c, ¼ lb. \$1.25.

New York No. 515. An extra early, dark green, sure heading variety; heads medium large. Compact form and of fine quality. Pkt. 10c, oz. 50c, ¼ lb. \$1.25.

Salamander. Fine compact heads which resist summer heat admirably. Pkt. 10c, oz. 40c, ¼ lb. \$1.00.

Simpson Early Curled. Early variety; good for forcing or open ground. Pkt. 10c, oz. 40c, ¼ lb. \$1.25.

Sutton's Supreme. A large, sure heading variety, slow to run to seed. The heads are creamy white, firm, crisp, and of fine quality. Pkt. 25c, ½ oz. 60c, oz. \$1.00.

Tennis Ball, Black Seeded, Select Strain. A very popular sort for open ground culture; forms a handsome head and is crisp and tender. Pkt. 10c, oz. 50c, ¼ lb. \$1.75.

White Boston. A sure, hard-heading variety, the heart and inner leaves are a rich yellow. It is deliciously flavored, very tender, of splendid quality. Pkt. 10c, oz. 50c, ¼ lb. \$1.25.

Romaine or Cos Lettuce

Sutton's Little Gem Cos. Dark green, small, solid, crisp, slow in running to seed, and of delicious quality. Pkt. 25c, ½ oz. 60c, oz. \$1.00.

Trianon Self-Closing Cos. The finest of the Cos varieties. Leaves long, narrow and erect. Pkt. 10c, oz. 40c, ¼ lb. \$1.00.

Leek

One ounce will sow 100 feet of drill

Sow as early in spring as practicable, in drills 1 inch deep and 1 foot apart. When 6 or 8 inches high, transplant in rows 10 inches apart each way.

Musselburgh, or Scotch. A very large variety of superior quality. Pkt. 10c; oz. 50c, ¼ lb. \$1.50.

Giant Carentan. Large size and extra fine quality. Pkt. 10c, oz. 50c, ¼ lb. \$1.50.

Large Flag Winter. Desirable for market or family use. Pkt. 10c, oz. 50c, ¼ lb. \$1.50.

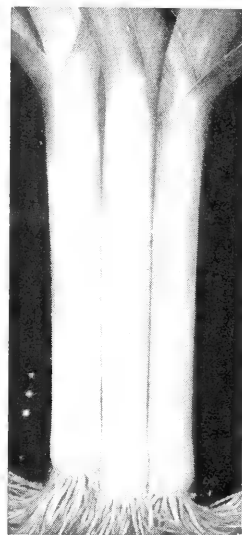

Leek

Martynia

One ounce will plant 100 hills.

Sow in the open ground in May, and thin out the plants to 2 or 3 feet apart, or a few seeds may be sown in a hotbed and afterward transplanted.

Proboseida. Pkt. 10c, oz. 50c.

Muskmelon

One ounce will plant 60 hills, two to three pounds for ■■
acre.

Plant in May, six to eight seeds to the hill, and when the plants are well up, thin out to three. Cultivate until the vines cover the ground, and pinch the ends of the growing shoots to induce early fruiting.

Green and Yellow Fleshed Varieties

Honey Ball. Flesh silvery green; juicy, with sweet honey-like flavor. Pkt. 10c, oz. 25c, $\frac{1}{4}$ lb. 75c.

Honey Dew. The melons are large, round to oval in shape. The light green flesh is luscious, juicy, solid, and of honey-like flavor. Pkt. 10c, oz. 25c, $\frac{1}{4}$ lb. 75c.

Miller's Cream. Nearly round, light green netted skin, with yellow flesh. Quality good. Pkt. 10c, oz. 25c, $\frac{1}{4}$ lb. 75c.

Montreal Market. The best Melon in cultivation. Fruits large size, beautifully netted and deeply ribbed. Flesh light green, sweet and of exquisite flavor. Pkt. 15c, oz. 75c.

Rocky Ford. One of the best varieties. Flesh thick and green; sweet and luscious. Pkt. 10c, oz. 25c, $\frac{1}{4}$ lb. 75c.

Red or Salmon Fleshed Varieties

Bender's Surprise. It is medium early with deep orange flesh, which is very thick and deliciously sweet. Pkt. 10c, oz. 25c, $\frac{1}{4}$ lb. 75c.

Delicious. An early variety. The fruits are large; flesh, deep orange color and very sweet. Pkt. 10c, oz. 35c, $\frac{1}{4}$ lb. \$1.00.

Emerald Gem. Small, extra early; smooth, ribbed, dark green skin and orange flesh; sweet. Pkt. 10c, oz. 25c, $\frac{1}{4}$ lb. 75c.

Grey's Selected A-1. Flesh deep orange color, very thick and sweet with a delicious flavor, large size and very productive. Pkt. 50c.

Hale's Best. An early variety, flesh is very thick and fine flavored. Pkt. 10c, oz. 25c, $\frac{1}{4}$ lb. 75c.

Hearts of Gold. Flesh very thick, deep salmon color, and of high quality. Pkt. 10c, oz. 25c, $\frac{1}{4}$ lb. 75c.

Lake Champlain (Golden Champlain). An exceedingly early salmon-fleshed Melon of medium size and fine quality. Pkt. 10c, oz. 25c, $\frac{1}{4}$ lb. 75c.

Oka. The color is a beautiful cream; flesh, ■ bright salmon color; sweet and juicy. Pkt. 50c.

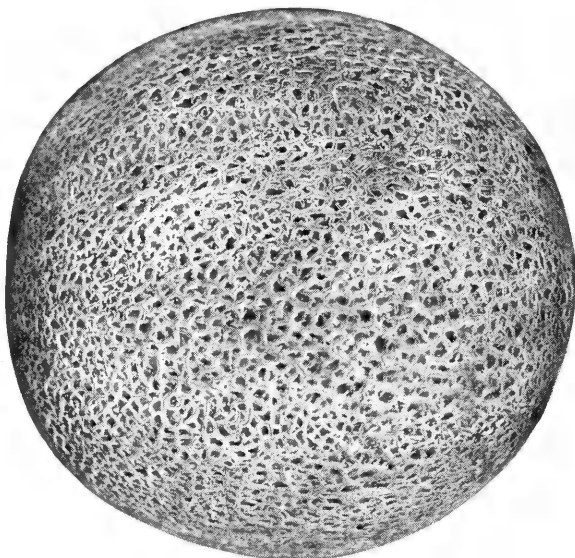

Rocky Ford Muskmelon

Muskmelons for Forcing

Blenheim Orange. Handsome scarlet flesh, superb flavor. Pkt. 75c.

Cotting's Hybrids. Flesh orange, oval shaped, delicious flavor Pkt. 50c.

Hero of Lockinge. Fruit handsome, flesh white, extremely rich in flavor. Pkt. 75c.

King George. Scarlet flesh, yellow skin, large, luscious fruits. Pkt. 75c.

Superlative. Flavor exceptionally fine, scarlet flesh, round fruits; very productive. Pkt. 75c.

Sutton's A-1. Rich scarlet flesh, large globular fruits; fine flavor. Pkt. 75c.

Watermelon

One ounce will plant 30 hills. Four pounds will plant
one acre.

Cultivate in the same manner as Muskmelons, but plant 8 to 10 feet apart.

Cole's Early. Very early variety; flesh very deep and sweet; color light green striped. Pkt. 10c, oz. 20c, $\frac{1}{4}$ lb. 60c.

Colorado Preserving. This is more productive than the common preserving Citron, and larger; the flesh is firm and solid. Pkt. 10c, oz. 20c, $\frac{1}{4}$ lb. 60c.

Dixie Queen. Fruit round or blunt, oblong, gray with prominent dark green stripes. Flesh richly colored, firm, sweet and juicy with very small white seeds. Pkt. 10c, oz. 20c, $\frac{1}{4}$ lb. 60c.

Early Fordhook. Extra early, good size, green skin, red flesh. Pkt. 10c, oz. 20c, $\frac{1}{4}$ lb. 60c.

Mountain Sweet. One of the best; rind thin, flesh scarlet, solid, very sweet and delicious. Pkt. 10c, oz. 20c, $\frac{1}{4}$ lb. 60c.

Phinney's Early. An early variety, of medium size; red fleshed, quality excellent. Pkt. 10c, oz. 20c, $\frac{1}{4}$ lb. 60c.

Tom Watson. The flesh is rich red color, solid, sweet and luscious. Pkt. 10c, oz. 20c, $\frac{1}{4}$ lb. 60c.



Cole's Early Watermelon



Mushrooms

One brick of Mushroom Spawn is sufficient for 10 square feet of bed.

A fine crop of mushrooms can be produced with very little labor or expense, provided a suitable location can be obtained. Cellars, sheds, or greenhouses can be used for their culture.

If wanted by mail, add postage at parcel post rates.

BRICK SPAWN, AMERICAN PURE CULTURE
Ten bricks will spawn 100 square feet (10x10 ft.)

Spores have been selected from specimen Mushrooms and transferred to bricks of compressed manure and loam. Break the brick into pieces the size of a walnut and plant 1 foot apart each way.

Per brick (about 1 1/2 lbs.)	\$0.40
Per 10 bricks	3.50
Per 25 bricks	7.50
Per 100 bricks	30.00

BOTTLE SPAWN

One quart will spawn 35 square feet. In this new method the mushroom spawn is the very best that can be produced. All materials have been sterilized and the spawn grown under absolutely germ-proof conditions. Each unit individually packed and containing complete instructions for the grower.

If wanted by parcel post, add 10c per carton for postage.

1 carton	1.25
10 cartons	12.00
25 cartons	29.25

The Book—"Modern Mushroom Culture" by Dr. J. Franklin Styer. It is the most modern, reliable treatise available. \$1.50 a copy.

Mustard

One ounce will sow 50 feet of drill.

For early crops the seed may be sown in a hotbed in March, and for general crop at frequent intervals through the spring, in drills from 8 to 12 inches apart.

Chinese Broad-leaved. Leaves much larger than the white Mustard. Flavor pleasantly sweet and pungent. Can be cooked like Spinach. Pkt. 10c, oz. 25c, 1/4 lb. 75c, lb. \$2.00.

Fordhook Fancy. Very ornamental. Plants of vigorous growth; cooked same as Spinach. Pkt. 10c, oz. 25c, 1/4 lb. 75c, lb. \$2.00.

White. Much used for salads; the seed is also used medicinally, and as a seasoning for pickles. Pkt. 10c, oz. 25c, 1/4 lb. 75c, lb. \$2.00.

Mustard Spinach

Tendergreen. A variety of greens producing large dark green leaves, fairly smooth, with light green center ribs; slow to seed, resistant to heat and drought; combines the flavor of mustard and spinach. It is ready for table or market in 21 to 25 days after planting. An excellent addition to the list of greens. Pkt. 10c, oz. 25c, 1/4 lb. 75c, lb. \$1.75.

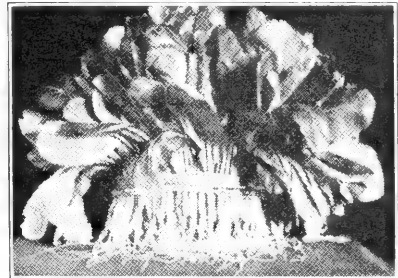

Mustard Spinach

Okra or Gumbo

One ounce will sow 40 feet of drill.

This plant is extensively cultivated for its green pods, which are used in soups and stews, and are very wholesome and nutritious. Sow about the middle of May, in drills 3 feet apart, and thin out the plants to 1 foot apart.

Improved Dwarf Green.
Very early; smooth pods. Pkt. 10c, oz. 25c, 1/4 lb. 75c.

White Velvet, or Creole.
Pods smooth, of large size, and a creamy white. Pkt. 10c, oz. 25c, 1/4 lb. 75c.



White Velvet Okra

Standard Mushroom or Hotbed Thermometers

Boxwood, metal tipped. Price \$3.50 each. Thermometers should whenever possible be sent by Express. We do not guarantee safe arrival if forwarded by Parcel Post.

Onions

One ounce will sow 100 feet of drill. Four or five pounds to the acre.

The Onion thrives best in light, loamy, mellow soil. The seed should be sown as early in the spring as the ground is in good working condition, in drills 14 inches apart, and covered $\frac{1}{4}$ inch deep. Keep free from weeds. A top dressing of wood ashes, applied after the second weeding, is very beneficial.

Ailsa Craig. Grows to a large size; very mild flavor; pale yellow. A valuable exhibition variety. Pkt. 15c, oz. 75c, $\frac{1}{4}$ lb. \$2.50.

Cranston's Excelsior. Handsome globe-shaped variety; large, solid, with small neck; straw color. An exhibition variety. Pkt. 15c, oz. 75c.

Danvers Yellow Globe. Selected with the greatest care; the true shape and color; a reliable and sure cropper. Pkt. 10c, oz. 50c, $\frac{1}{4}$ lb. \$1.75.

Danvers Yellow Globe. Selected Strain. The finest type of this popular variety on the market. Pkt. 25c, oz. \$1.00, $\frac{1}{4}$ lb. \$3.00.

Gigantic Gibraltar. A handsome straw-colored Onion of enormous size, possessed of many sterling qualities. Grand for exhibition. Pkt. 15c, oz. 75c.

Large Red Wethersfield. The leading red variety of the East; almost round; deep red color; grows to good size and is a good keeper. Pkt. 10c, oz. 50c, $\frac{1}{4}$ lb. \$1.75.

Mammoth Silver King. Of attractive shape, with silvery white skin and flesh of a most agreeable mild flavor. Pkt. 10c, oz. 50c, $\frac{1}{4}$ lb. \$1.75.

Prizetaker. Of a rich straw color and enormous size, averaging 12 to 14 inches in circumference. Pkt. 10c, oz. 50c, $\frac{1}{4}$ lb. \$1.75.

Southport Red Globe. A good late sort. Keeps well. Pkt. 10c, oz. 50c, $\frac{1}{4}$ lb. \$1.75.

Southport Yellow Globe. A fine large variety. Somewhat later than the Danvers. Pkt. 10c, oz. 50c, $\frac{1}{4}$ lb. \$1.75.

The Queen. A handsome silver-skinned variety; esteemed for its rapid growth, mild flavor and fine keeping qualities. Pkt. 10c, oz. 50c, $\frac{1}{4}$ lb. \$1.75.

White Globe. Of mild flavor; skin silvery white; flesh fine grained, good keeper. Pkt. 10c, oz. 50c, $\frac{1}{4}$ lb. \$1.75.

White Portugal, or Silverskin. Bulbs of medium size; flattened; skin silvery white; flesh fine grained and mild flavored. Pkt. 10c, oz. 50c, $\frac{1}{4}$ lb. \$1.75.

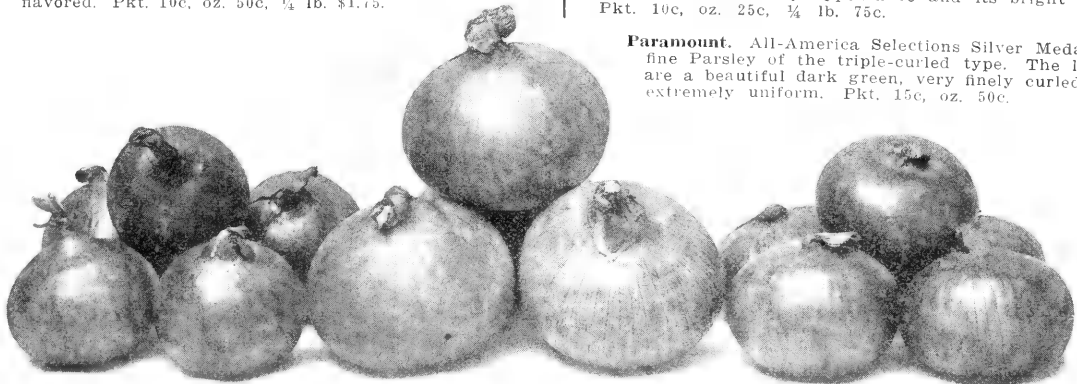

Southport Red Globe

Danvers Yellow Globe

Red Wethersfield

Onion Sets

These are small Onions grown the previous year, ripened off and taken up when mere bulblets. They produce a very early crop, and grow in any good soil. Set them 3 or 4 inches apart in rows 1 foot apart.

If wanted by parcel post, add postage at zone rates.

	Lb.	4 lbs.	8 lbs.
White Onion Sets	\$0.35	\$1.25	\$2.25
Yellow Onion Sets	.30	1.10	2.00
Red Onion Sets	.30	1.10	2.00
Yellow Japanese or Ebenezer	.30	1.10	2.00
Shallots	.50	1.75	3.25
White Potato (Multiplier)	.50	1.75	3.25
Yellow Potato	.50	1.75	3.25

Parsley

One ounce will sow 150 feet of drill.

Sow early in the spring in drills 1 foot apart and $\frac{1}{2}$ inch deep. Thin out the young plants to 4 inches. Hamburg Parsley should be treated the same as carrots.

Double Curled, Dwarf. finely curled; excellent for table and edgings. Pkt. 10c, oz. 25c, $\frac{1}{4}$ lb. 75c.

Dobbie's Exhibition. This Parsley has long been recognized as a standard exhibition sort. It is remarkable for its large, fine leaves and close habit. The seed offered has been saved from selected plants only; every one was a perfect specimen. Pkt. 25c, oz. 75c.

Grey's Perfection. Beautifully curled and highly ornamental. Pkt. 25c, oz. 75c.

Hamburg, or Rooted. The roots are used for flavoring. Pkt. 10c, oz. 30c, $\frac{1}{4}$ lb. \$1.00.

Moss Curled. One of the finest varieties for garnishing on account of its mossy appearance and its bright color. Pkt. 10c, oz. 25c, $\frac{1}{4}$ lb. 75c.

Paramount. All-America Selections Silver Medal. A fine Parsley of the triple-curved type. The leaves are a beautiful dark green, very finely curled and extremely uniform. Pkt. 15c, oz. 50c.

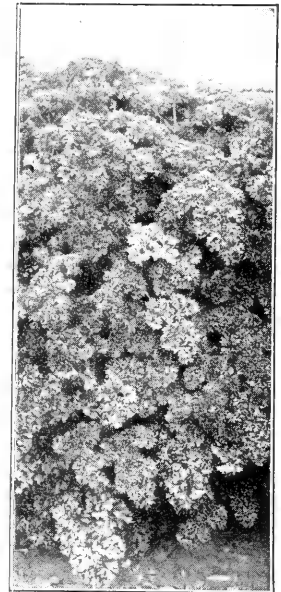

Grey's Perfection Parsley

PEAS

Two lbs. of peas will plant 100 feet of drill; 90 lbs., to the acre.

Peas succeed best in light, rich soil. The early round, smooth varieties should be planted as early in spring as possible, while the wrinkled sorts, which are more tender, will do better if planted after the ground becomes warmer. Sow in drills, 2 to 3 feet apart, according to variety, and cover early sowing about 2 inches; later plantings should be covered 3 to 4 inches. Successive plantings can be made every ten days up to the middle of July. For the later plantings the early varieties are preferred.

Free Delivery. We will prepay Parcel Post charges on cash orders at quoted catalogue prices on Peas, up to two pounds, anywhere in the United States, east of the Mississippi River; for larger quantities, the purchaser pays transportation charges.

Before planting Peas
inoculate seed with

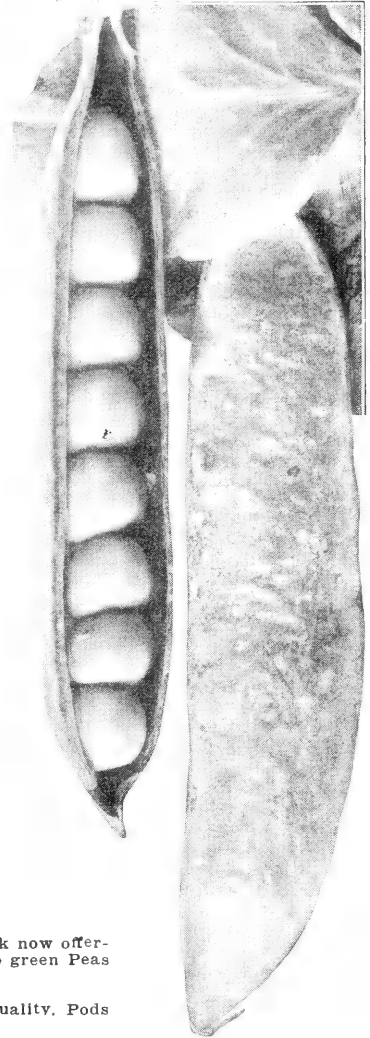

Gradus Peas

Alaska or Clipper. A valuable variety either for private use or for market. Pods well filled. 2½ ft. ½ lb. 20c, 1b. 30c, 2 lbs. 55c.

Blue Bantam. A fine extra early wrinkled Pea. Large pods well filled with deep green, fine flavored Peas. Height 2¼ ft. ½ lb. 20c, 1b. 35c, 2 lbs. 60c.

Early Morn. Of Gradus type. Early, with large pods and Peas of good flavor. 3 ft. ½ lb. 20c, 1b. 35c, 2 lbs. 60c.

Gradus. (Prosperity). Large, handsome pods, well filled, ripening with the earliest; pods long, straight, slightly rounded at the point. 3 ft. ½ lb. 20c, 1b. 35c, 2 lbs. 60c.

Grey's Perfection. One of the earliest Peas in cultivation; the pods, which are numerous, contain six or seven good-sized Peas. Very productive and of fine flavor. 2½ ft. ½ lb. 25c, 1b. 40c, 2 lbs. 75c.

Hundredfold. A splendid large-podded dwarf variety; the pods are 4 inches long and well filled with large deep green Peas of fine quality. The vines grow 16 to 18 inches high and very strong. This is one of the best dwarf early Peas for the home garden and market. ½ lb. 20c, 1b. 35c, 2 lbs. 60c.

Laxton's Superb. A splendid early semi-wrinkled variety. Hardy and very productive. Pods large and well-filled. Height 1½ inches. ½ lb. 20c, 1b. 35c, 2 lbs. 60c.

Laxtonian, Re-Selected. This fine new Pea has been carefully selected, and the stock now offered is saved from deep green, giant pods only. Pods are slightly curved and deep green Peas are of excellent flavor. ½ lb. 20c, 1b. 35c, 2 lbs. 60c.

Little Marvel. This is one of the best dwarf Peas; a heavy cropper and of best quality. Pods green, blunt-ended and well filled. ½ lb. 20c, 1b. 35c, 2 lbs. 60c.

Pilot. An extra early round-seeded or smooth Pea. Can be planted as soon as ground can be worked. Pods as large as the Gradus. Very prolific, highly recommended as an extra early market sort. ½ lb. 20c, 1b. 35c, 2 lbs. 60c.

Sutton's Excelsior. An extra early, dwarf, wrinkled Pea. Fully as early as the American Wonder, with much broader pods, filled with large Peas of the finest flavor 1½ ft. ½ lb., 20c, 1b. 35c, 2 lbs. 60c.

Thomas Laxton. One of the best early wrinkled Peas yet introduced; very productive with large, well-filled pods. 3 ft. ½ lb. 20c, 1b. 35c, 2 lbs. 60c.

World's Record. An earlier strain of the well-known Gradus Peas. Medium green, moderately stout vines, bearing medium green pods, 4 inches long, which are fairly broad, pointed and well filled with from 7 to 9 very fine dark green Peas. ½ lb. 20c, 1b. 35c, 2 lbs. 60c.

Second Early and Late Varieties

Alderman. A large-podded wrinkled Pea of robust habit. Pods 4 to 5 inches long, well filled with Peas of excellent flavor. 3½ feet. ½ lb. 20c, 1b. 35c, 2 lbs. 60c.

Admiral Beatty. A new and very popular variety, highly productive and of excellent quality. Height 4 feet, pods large, green, and produced in pairs. ½ lb., 20c, 1b. 35c, 2 lbs. 60c.

Canada Field. See page 66.

Champion of England. A standard variety; very sweet and delicious. One of the best and most popular. 5 ft. ½ lb. 20c, 1b. 35c, 2 lbs. 60c.

Dwarf Telephone. Season medium. Pods long, remarkably well filled, color pale green; peas large, tender and of delicious flavor. 1½ ft. ½ lb. 20c, 1b. 35c, 2 lbs. 60c.

Everbearing Bliss. A continuous bearing variety of especial value for late summer and autumn. Pods 3 to 4 in. long, producing 6 to 8 large wrinkled peas; quality unsurpassed. 2 ft. ½ lb. 20c, 1b. 35c, 2 lbs. 60c.

French Canner (Petit Pois). Very prolific, with long slim, curved pods, containing seven to nine peas. 3 to 3½ ft. ½ lb. 30c, 1b. 50c, 2 lbs. 90c.

Mammoth Melting Sugar. Best of all the edible-podded Peas. Pods straight, smooth, brittle and delicious. 3 ft. ½ lb. 25c, 1b. 40c, 2 lbs. 75c.

Peas—Continued

Sutton's Super V. C. The largest podded Pea in existence; height from 5 to 6 ft. Large pods of fine flavor, an exhibition variety. $\frac{1}{2}$ lb. 45c, lb. 80c, 2 lbs. \$1.50.

The Britisher. Pods are perfectly straight; pointed at the ends, and of a medium green color, containing large, nicely flavored peas. 4 ft. Main crop; wrinkled. $\frac{1}{2}$ lb. 60c, lb. \$1.10, 2 lbs. \$2.00.

Quite Content, Carter. A main crop variety; grows 5 feet high; foliage and pod deep green; pods 3 to 7 in. long, hanging mostly in pairs; ten to twelve peas in a pod. Flavor superb. $\frac{1}{2}$ lb. 25c, lb. 40c, 2 lbs. 75c.

Stratagem. A heavy cropper, and produces large, remarkably well filled pods of excellent flavor. One of the best. 2 ft. $\frac{1}{2}$ lb. 20c, lb. 35c, 2 lbs. 60c.

Telephone. Immensely productive, the pods are of large size and closely packed with large, delicious peas. 4 ft. $\frac{1}{2}$ lb. 20c, lb. 35c, 2 lbs. 60c.

The Miracle. An early main crop, wrinkled variety. Height 4 feet, pod long, very deep green, well filled with peas of rich color and exquisite flavor. A heavy cropper. $\frac{1}{2}$ lb. 20c, lb. 35c, 2 lbs. 60c.

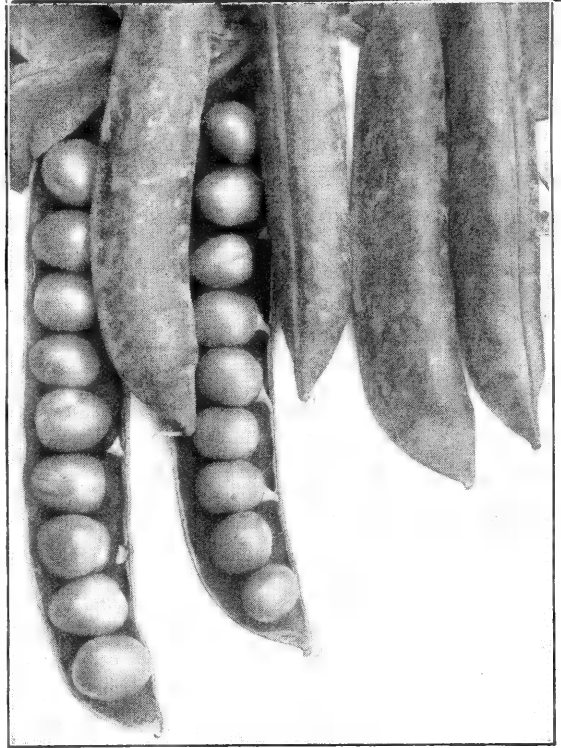

Telephone Peas

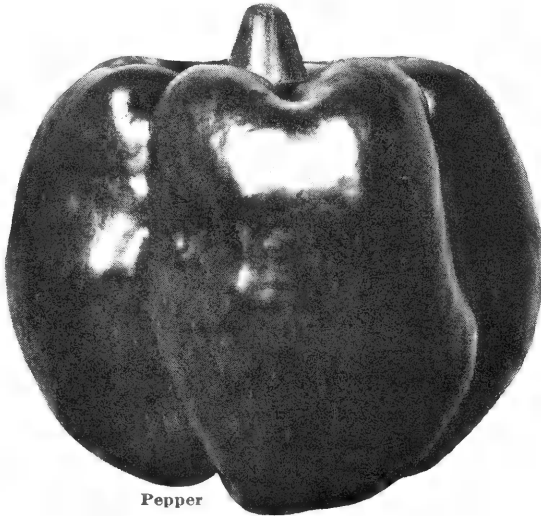

Pepper

Parsnips

One ounce will sow 100 feet of drill. Five to six pounds to the acre.

Sow in April or early in May, as Parsnips require a long season to mature. Their cultivation is otherwise the same as directed for Carrots. If left in the ground till the following spring, they are very much improved in flavor.

Arlington Long White. A good variety for general use; long and smooth. Pkt. 10c, oz. 20c, $\frac{1}{4}$ lb. 50c.

Early Round. The earliest variety in cultivation, of good flavor but of small size. Pkt. 10c, oz. 30c, $\frac{1}{4}$ lb. \$1.00.

Hollow-Crowned. Roots very long, white, smooth and sweet. Excellent flavor. Pkt. 10c, oz. 20c, $\frac{1}{4}$ lb. 50c.

Student. A favorite English variety; tender and smooth. Pkt. 10c, oz. 30c, $\frac{1}{4}$ lb. \$1.00.

Pepper

One ********* will produce about 1500 plants.

Sow in March or April in a hotbed and transplant into open ground late in May or early in June when the weather has become well settled, as the plants are quite tender. Set in rows about 3 feet apart, and 15 inches apart in the row. A warm, sandy loam is best suited to their growth.

California Wonder. A sweet variety of great merit. Heavily productive over a long season. Fruits very large, smooth and regular. Pkt. 15c, oz. 60c, $\frac{1}{4}$ lb. \$2.00.

Chinese Giant. Very large, flesh mild and thick. Pkt. 10c, oz. 50c, $\frac{1}{4}$ lb. \$1.50.

Harris Early Giant. The plants produce enormous yield. The Peppers are deep green turning to brilliant red. Flesh thick and of a very sweet flavor. Pkt. 15c, oz. 60c, $\frac{1}{4}$ lb. \$2.00.

Large Bell, or Bull Nose. Good for Mangoes; early, sweet and less pungent than many; one of the best. Pkt. 10c, oz. 50c, $\frac{1}{4}$ lb. \$1.50.

Long Red Cayenne. A long, slim pod, rather pointed, and when ripe, of a bright red color, extremely strong and pungent. Pkt. 10c, oz. 50c.

Neapolitan Large Early. The earliest of the large, sweet Peppers. Pkt. 10c, oz. 50c, $\frac{1}{4}$ lb. \$1.50.

Ruby King. Long, about 1 in.; very thick, fine, mild flavor. Pkt. 10c, oz. 50c, $\frac{1}{4}$ lb. \$1.50.

Squash. Flesh thick, mild and pleasant to the taste, though more piquant than some. Pkt. 10c, oz. 50c, $\frac{1}{4}$ lb. \$1.50.

Sunnybrook. The fruit measures 2½ to 3 in. thick and 2 to 2½ in. deep. The flesh is unusually thick and very sweet. Pkt. 10c, oz. 50c, $\frac{1}{4}$ lb. \$1.50.

Windsor "A". All-America Selections Silver Medal. Somewhat the shape and size of Ruby King, plus the thick walls of California Wonder. It is smooth shaped, mostly three-lobed. Pkt. 15c, oz. 75c.

World Beater. Fruits large, oblong, commonly 5 inches long and 3½ inches in diameter; deep green becoming bright deep red; flesh thick and sweet. Pkt. 10c, oz. 50c, $\frac{1}{4}$ lb. \$1.50.

Seed Potatoes

One peck will plant 100 hills; 8 to 10 bushels an acre.

Owing to unsettled market conditions prices will be given on application.

Use Semesan Bel. Dusted on your seed potatoes at planting time, it controls disease and produces increased yields of healthy plants and tubers. **One pound will treat 60 to 80 bushels.** 4 ozs., 45c; 1 lb., \$1.50; 5 lbs., \$6.75; 25 lbs., \$31.00.

EARLY VARIETIES

CHIPPEWAW. A heavy cropping early variety; the tubers are oval shape, skin white, for table quality. One of the best.

EARLY ROSE. (Selected). A pink-skinned variety which is grown extensively in some sections. A potato of good size and fine quality.

IRISH COBBLER. (Certified stock). Cream-white color and of excellent quality. A vigorous grower, ripens uniformly, and keeps well.

LATE VARIETIES

GREEN MOUNTAIN. (Certified stock). We can recommend this variety as one of the best for all purposes.

KATAHDIN. Matures about a week later than Irish Cobbler. White skin and white flesh, with a very shallow eye. Handsome oval shape. Excellent cooking quality.

RURAL RUSSET. A reliable late variety, practically blight-resistant. Quality excellent. A good keeper.

SPAULDING ROSE. A valuable late potato of exceptional quality. Cooks white and mealy; does well in light soils.

Radish

One ounce will sow about 100 feet of drill, 10 lbs. an acre.

Culture—Sow in the open as early as the ground can be worked. Tobacco Dust scattered in the row will help keep maggots in check.

Early Crimson Giant. Grows to a large size without becoming pithy. Excellent for forcing. Pkt. 10c, oz. 25c, ¼ lb. 60c.

Early Scarlet Globe. Of distinct shape, brilliant color, crisp and white; excellent for forcing. Pkt. 10c, oz. 25c, ¼ lb. 60c, lb. \$1.75.

Early Scarlet Turnip. Small, round Radish; very tender, mild and of quick growth. Pkt. 10c, oz. 25c, ¼ lb. 60c.

French Breakfast. Scarlet, with white tip; shape nearly oval; good for forcing or summer sowing. Pkt. 10c, oz. 20c, ¼ lb. 60c.

Icele. Quick growing; clear white. Fine for forcing. Pkt. 10c, oz. 25c, ¼ lb. 60c.

Long Black Spanish. One of the hardest and best for winter use. Pkt. 10c, oz. 25c, ¼ lb. 60c.

Round Black Spanish. Skin black; roots globe-shaped; white fleshed and piquant flavor. Pkt. 10c, oz. 20c, ¼ lb. 60c.

Saxa. A popular Radish for both forcing and for outdoor use. The root is as round as a ball, and a bright scarlet color. As this variety is very early and the top very short, it is rapidly gaining favor. Pkt. 10c, oz. 25c, ¼ lb. 75c.

White Stuttgart. A quick growing variety of large size and of good quality. Pkt. 10c, ¼ lb. 25c.

Sweet Potato Plants

Culture—The young plants should be set in hills about 4 feet apart and 5 inches above the ground level. A light soil and sunny location are preferable. Rooted slips ready in May.

Nansemond. Best sort for New England. Plants, \$1.25 per 100, \$10.00 per 1000; add 15c per 100 if wanted by parcel post.

Pumpkin

One ounce will plant 20 hills. One pound 250 hills.

Sow in good soil in May, when the ground has become warm, in hills 8 to 10 feet apart each way; or in fields of Corn, about every fourth hill. The Pumpkin is not so particular in regard to soil as the Melon or Cucumber, but in other respects is cultivated in a similar manner. If planted in hills by themselves, thin out the plants when beginning to run, to three in each hill.

Connecticut Field. A large yellow variety, productive, and grown for feeding stock. Pkt. 10c, oz. 15c, ¼ lb. 50c, lb. \$1.50.

Mammoth. A productive variety, which grows to an immense size, often weighing more than a hundred pounds. Pkt. 10c, oz. 25c, ¼ lb. 75c, lb. \$2.50.

Sugar. A small, fine-grained, sweet Pumpkin; very prolific and a fine table variety. Pkt. 10c, oz. 15c, ¼ lb. 50c, lb. \$1.50.

Winter Luxury. Flesh thick, sweet and excellent for pies. Pkt. 10c, oz. 25c, ¼ lb. 75c.

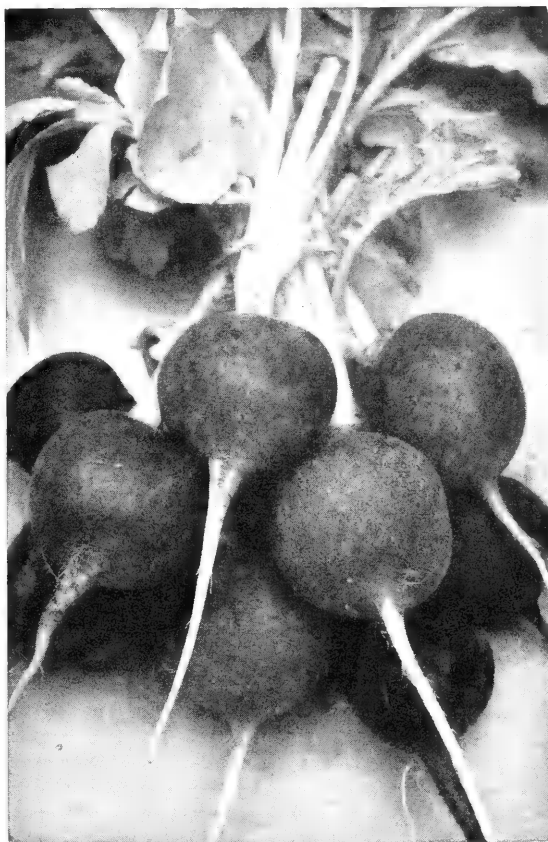

Early Scarlet Globe Radish

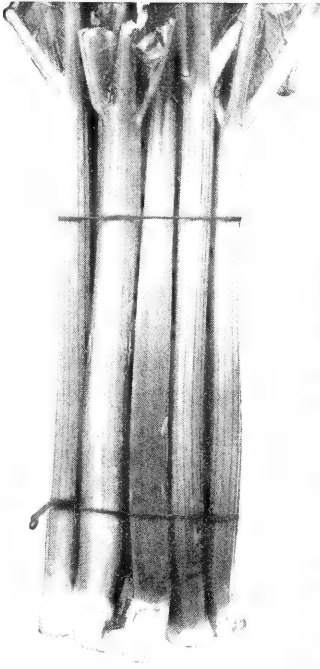

Linnaeus Rhubarb

Mammoth Sandwich
Island Salsify

Spinach

One oz. will sow 100 feet of drill; 12 lbs. will sow an acre.

Sow in March or April in drills an inch deep and 14 inches apart; again in August or September. Spinach requires rich soil.

Packets 10c, except where noted.

Bloomsdale or Savoy-Leaved. A valuable variety with wrinkled leaves, resembling the Savoy cabbage. Pkt. 10c, oz. 20c, $\frac{1}{4}$ lb. 50c, lb. \$1.75.

King of Denmark. Especially desirable for sowing during April and May. Pkt. 10c, oz. 20c, $\frac{1}{4}$ lb. 50c, lb. \$1.75.

Mustard Spinach. (See page 53.) Pkt. 10c, oz. 25c, $\frac{1}{4}$ lb. 75c, lb. \$1.75.

New Zealand (*Tetragonia expansa*). May be started in a hotbed and transplanted or sown out-of-doors when the ground is warm, allowing two feet between the plants. Pkt. 10c, oz. 25c, $\frac{1}{4}$ lb. 75c, lb. \$2.25.

Nobel Giant-Leaved. By far the best of the so-called smooth-leaved varieties. Pkt. 10c, oz. 20c, $\frac{1}{4}$ lb. 50c, lb. \$1.75.

Old Dominion. A large, dark green, savoy-leaved Spinach; good for spring and fall planting. Pkt. 10c, oz. 20c, $\frac{1}{4}$ lb. 50c, lb. \$1.75.

Perpetual or Spinach Beet. Produces green leaves in abundance close to the ground, and will give a constant supply through the season. Pkt. 10c, oz. 20c, $\frac{1}{4}$ lb. 60c, lb. \$2.00.

Round Thick-Leaved. Leaves large, thick and fleshy; the variety generally grown for market and equally good for spring or fall sowing. Pkt. 10c, oz. 20c, $\frac{1}{4}$ lb. 50c, lb. \$1.75.

Savoy Blight-Resistant. A valuable variety to use for fall sowing. Pkt. 10c, oz. 20c, $\frac{1}{4}$ lb. 50c, lb. \$1.75.

Savoy-Leaved, Long-Standing. Darker green and more heavily crumpled than Bloomsdale. Pkt. 10c, oz. 20c, $\frac{1}{4}$ lb. 50c, lb. \$1.75.

Summer Savoy. All-America Selections Bronze Medal. Will stand several days longer without bolting to seed than Long Standing Bloomsdale, which it resembles in appearance. Pkt. 10c, oz. 20c, $\frac{1}{4}$ lb. 50c.

Viking. A large, dark green leaved, long standing Spinach, grows very rapidly. Excellent for spring sowing. Pkt. 10c, oz. 20c, $\frac{1}{4}$ lb. 50c, lb. \$1.75.

All prices subject to change without notice

Rhubarb

One ounce will produce about 750 plants.

Rhubarb succeeds best in deep, rich loam. It is propagated by seed, or by division of the roots—the latter being the usual method. Sow the seeds in drills 18 inches apart, and thin out the plants to 9 inches apart in the drills. When the plants are one year old transplant into beds, setting the plants 5 feet apart each way. Do not cut until the second year and give a liberal dressing of manure every fall.

Linnaeus. The earliest and best for garden use; not as coarse and fibrous as the larger sorts. Pkt. 10c, oz. 50c, $\frac{1}{4}$ lb. \$1.50.

Victoria. The variety in general use for the market; yields immense crops. Pkt. 10c, oz. 50c, $\frac{1}{4}$ lb. \$1.50.

Roots. Either variety. Each 35c, doz. \$3.00.

Salsify or Vegetable Oyster

One ounce will sow 50 feet of drill.

Sow the seed early in spring, in drills 12 inches apart and 1 inch deep, thinning out the young plants to 6 inches. The roots will be ready for use in October, when a supply should be taken up and stored like Carrots. Those remaining will suffer no injury by being left in the ground till spring.

Long White French. Pkt. 10c, oz. 35c, $\frac{1}{4}$ lb. \$1.25.

Mammoth Sandwich Island. Tender and delicious; very superior. Pkt. 10c, oz. 30c, $\frac{1}{4}$ lb. \$1.00.

Sorrel

Broad-Leaved French. Used cooked as spinach or to mix with salads, sow seed in spring in good light soil in shallow drills one foot apart, thin out to four inches apart in the row; when the seed stalks appear, they should be cut out. Pkt. 10c, oz. 50c, $\frac{1}{4}$ lb. \$1.50, lb. \$4.00.

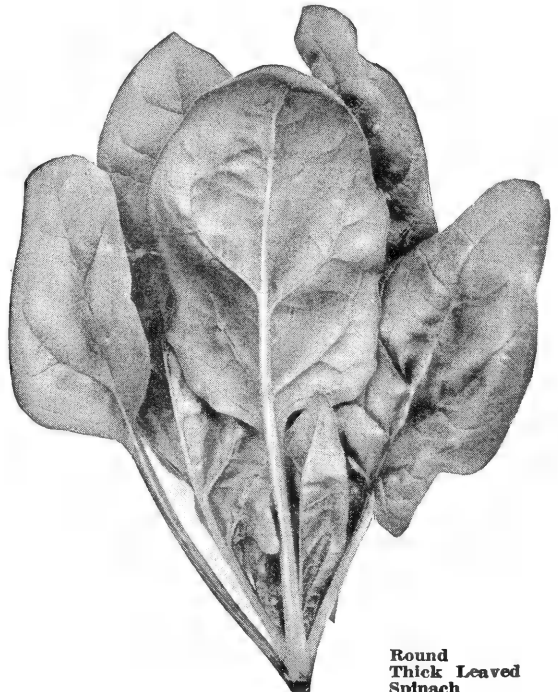
Round
Thick Leaved
Spinach

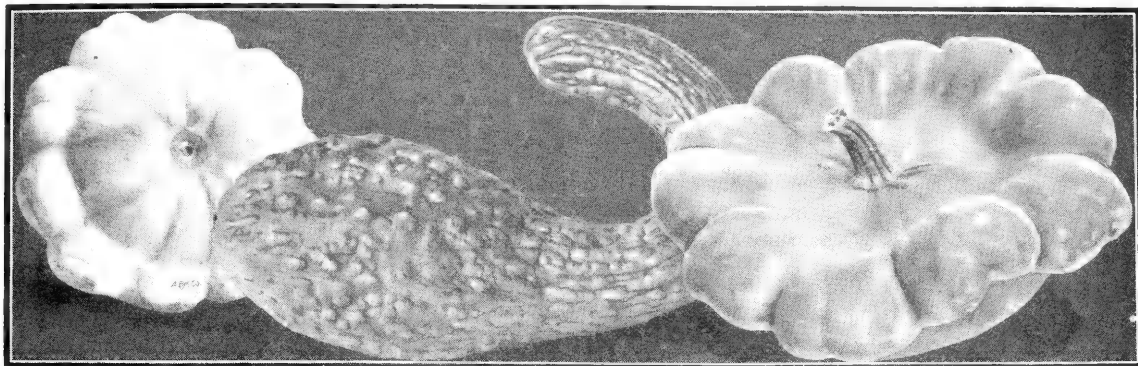

Early Mammoth White Scalloped

Giant Summer Crookneck

Early Yellow Scalloped

Squash

One ounce of the small-seeded variety will plant 40 hills; of large-seeded, 15 hills.

Squash, being very tender and sensitive to cold, should not be planted until the weather becomes warm and settled. Plant in well-manured hills, in the same manner as Cucumbers and Melons, the bush varieties 3 or 4 ft. apart each way, and the running kinds from 6 to 8 ft. apart. Sow 8 to 10 seeds to a hill, thinning out after they have attained their rough leaves, and danger from bugs is past, leaving two or three of the strongest plants in each hill.

Boston Marrow. A fall and winter variety of oval form, skin thin; when ripe, bright orange; an excellent keeper and of superior quality. Pkt. 10c, oz. 25c, ¼ lb. 75c.

Connecticut Straightneck. (Lemon Color). All-America Selections Honorable Mention. It is a smaller and less warted Straightneck, early, and with a very light lemon-yellow color. Pkt. 10c, oz. 50c.

Delicious. One of the best varieties for table use. It is a fall and winter Squash, excellent at all seasons. Pkt. 10c, oz. 25c, ¼ lb. 75c.

Des Moines. It is a small, dark green, acorn-shaped Squash, almost black in color, usually about 6 inches long and 4 in. in diameter. Pkt. 10c, oz. 25c, ¼ lb. 75c.

Early Mammoth White Scalloped. One of the earliest summer Squashes; flat, scallop-shaped; light cream color. Pkt. 10c, oz. 25c, ¼ lb. 75c.

Early Giant Summer Crookneck. Very early variety; long shape and of a bright yellow color. Pkt. 10c, oz. 25c, ¼ lb. 75c, lb. \$2.00.

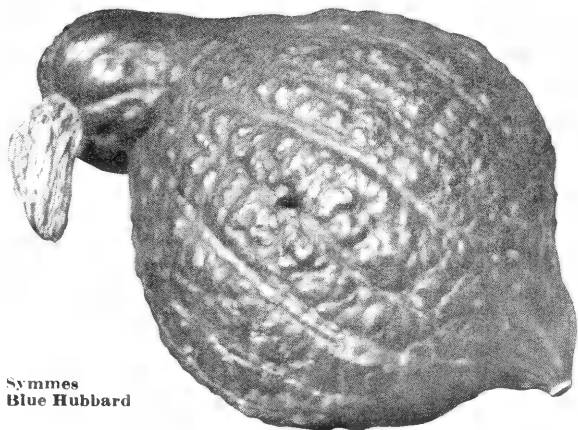

Symmes
Blue Hubbard

Early Prolific Straightneck. All-America Selections Silver Medal. Similar to Connecticut Straightneck, but is slightly more warted, and a little deeper yellow when young. It is very productive. Pkt. 10c, oz. 50c.

Giant Straightneck Summer. Despite its large size the flesh is rich and fine flavored. Its attractive appearance has made it popular with the market gardeners. Pkt. 10c, oz. 25c, ¼ lb. 75c, lb. \$2.50.

Golden Delicious. In shape, size, and season it is practically the same as the original Delicious. Its deep orange colored shell and thick dry orange flesh of superb flavor and texture. Pkt. 10c, oz. 25c, ¼ lb. 75c.

Hubbard. Standard winter Squash. Color green, shell extremely hard; flesh dry, fine grained and sweet; excellent keeper. Pkt. 10c, oz. 25c, ¼ lb. 75c, lb. \$2.50.

Hubbard, Golden. Earlier than Hubbard; color a rich orange-red; hard and warty. Pkt. 10c, oz. 25c, ¼ lb. 75c, lb. \$2.50.

Hubbard, Symmes Blue. A superior strain, thick meated, fine grained, dry and very sweet. A heavy cropper and good keeper. Pkt. 10c, oz. 35c, ¼ lb. \$1.25.

The Warren. Resembles the Essex Hybrid but has a shell generally harder and thicker. The color is of a richer and deeper orange. The flesh is of excellent quality. Pkt. 10c, oz. 35c, ¼ lb. \$1.25.

Vegetable Marrow, English. Grows about 9 inches long. Pale straw colored, changing to a deeper shade. Flesh white. Pkt. 10c, oz. 25c, ¼ lb. 75c.

Vegetable Marrow, Italian (Cocozelle di Napoli). Skin smooth, mottled, dark and light green. Grows from 12 to 20 inches long. Flesh delicate green; quality fine. Pkt. 10c, oz. 25c, ¼ lb. 75c.

Vegetable Spaghetti. The fruit of this variety is creamy white, about 8 inches long and 4 to 5 inches in diameter. When mature, boil whole for twenty to thirty minutes, cut open, remove the center, seed core, and season the flesh with butter and salt. This is a most delicious and tasty vegetable. Pkt. 10c, oz. 25c, ¼ lb. 75c.



Giant Summer
Straightneck

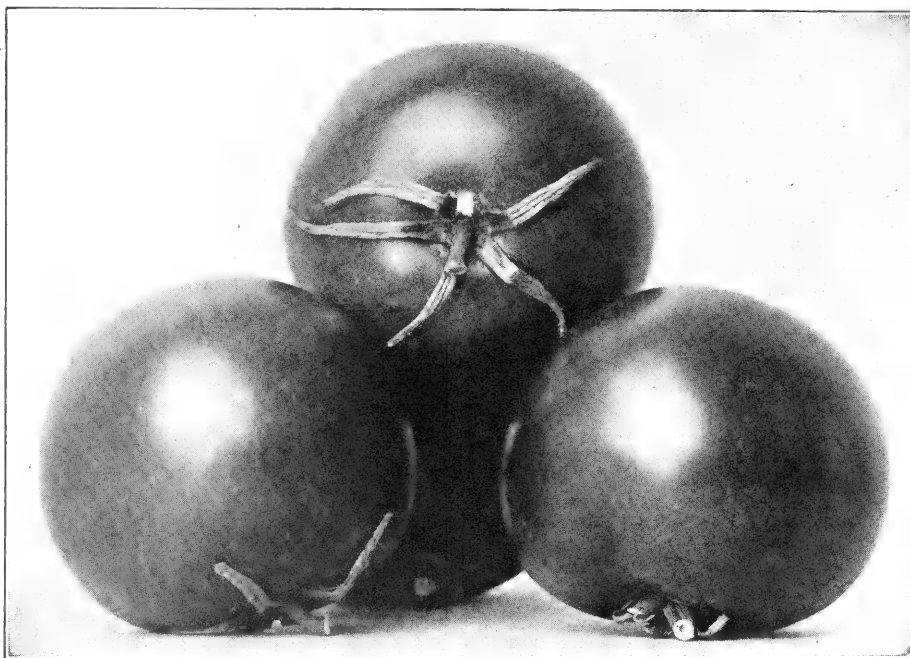

Tomato, Lister's Prolific

Tomato

One ounce will produce 1500 plants.

Sow seed in a hotbed the first week in March, in drills 5 inches apart. When the plants are about 2 inches high they should be set out 4 or 5 inches apart in another hotbed, or removed into small pots, allowing a single plant to a pot. About the middle of May the plants may be set

out in the open ground; they are planted for early crops on light, sandy soil, at a distance of 3 feet apart.

Bonny Best. Early, productive. Smooth, solid and uniform in size; scarlet. Pkt. 10c, oz. 40c, $\frac{1}{4}$ lb. \$1.50.

Break o' Day. An early Tomato of the Marglobe type, fruit of good size, color scarlet; smooth and of good quality. Pkt. 10c, oz. 50c, $\frac{1}{4}$ lb. \$1.75.

Chalk's Early Jewel. Large, solid, smooth, bright red variety. Pkt. 10c, oz. 40c, $\frac{1}{4}$ lb. \$1.50.

Comet. One of the best for forcing; brilliant scarlet color, medium size, smooth and solid. Pkt. 10c, oz. 75c, $\frac{1}{4}$ lb. \$2.25.

Dwarf Champion. Of compact, upright growth. Fruit solid, smooth, purplish red. Pkt. 10c, oz. 40c, $\frac{1}{4}$ lb. \$1.50.

Dwarf Stone. Resembles Dwarf Champion; fruit larger and more prolific; fine color. Pkt. 10c, oz. 40c, $\frac{1}{4}$ lb. \$1.50.

Earliana. The earliest red Tomato. Very smooth; fine for market. Pkt. 10c, oz. 40c, $\frac{1}{4}$ lb. \$1.50.

Golden Ponderosa. A large golden yellow variety of excellent quality. Pkt. 10c, oz. 50c, $\frac{1}{4}$ lb. \$1.50.

Globe, Livingston's. Very early; large, smooth variety. Pkt. 10c, oz. 40c, $\frac{1}{4}$ lb. \$1.50.

John Baer. An early bright scarlet new Tomato. Large and fleshy. Pkt. 10c, oz. 40c, $\frac{1}{4}$ lb. \$1.50.

Lister's Excelsior. One of the best for forcing or outdoor culture; a heavy cropper of good flavor and color. Original pkt. 75c.

Lister's Prolific. This variety planted out or grown in a greenhouse has proved a remarkably valuable variety. Pkt. 75c.

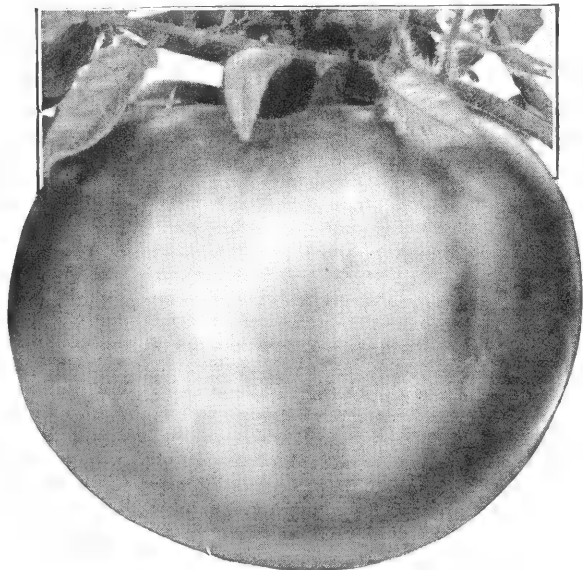

John Baer Tomato

Tomatoes—Continued

Lister's Protection. The best of Lister's productions. Color dark crimson, a heavy cropper, perfect in shape and size. Pkt. \$1.00.

Marglobe. A midseason variety entirely immune from rust, pure scarlet, globe-shaped. Good size, heavy cropper and fine quality. Pkt. 10c, oz. 40c.

Michigan State. One of the best varieties for forcing. Fruits medium-sized. Color deep scarlet. Flesh thick and firm, of excellent quality and fine flavor. Pkt. 25c, oz. \$2.00.

Penn State. An early variety, color rich scarlet, flesh dark red, quality and flavor of the finest. Pkt. 10c, oz. \$1.85, ¼ lb. \$6.00.

SMALL FRUITED VARIETIES

Red Cherry. Valuable for preserving. Pkt. 10c, oz. 50c, ¼ lb. \$1.50.

Red Currant. Very small. Used in preserves. Pkt. 10c, oz. 50c, ¼ lb. \$1.50.

Red Peach. A small pink-fruited variety. Pkt. 10c, oz. 50c, ¼ lb. \$1.50.

Red Pear. Solid, handsome fruit. Good preserving variety. Pkt. 10c, oz. 50c, ¼ lb. \$1.50.

Red Plum. Valuable for salads. Pkt. 10c, oz. 50c, ¼ lb. \$1.50.

Strawberry Tomato or Winter Cherry. Fruit grows in a husk and will keep all winter. Pkt. 10c, oz. 50c, ¼ lb. \$1.50.

Yellow Cherry. Same as Red Cherry except for color. Pkt. 10c, oz. 50c, ¼ lb. \$1.50.

Yellow Peach. Fruits have a beautiful Peach appearance. Pkt. 10c, oz. 50c, ¼ lb. \$1.50.

Yellow Pear. Fruits set in large cluster. Pkt. 10c, oz. 50c, ¼ lb. \$1.50.

Yellow Plum. Valuable for salads and pickling. Pkt. 10c, oz. 50c, ¼ lb. \$1.50.



Plum Shaped Yellow Tomato

Ponderosa. Very large, solid and of excellent flavor. Pkt 10c, oz. 40c, ¼ lb. \$1.50.

Pritchard. (Certified). All-America Selections Gold Medal. A disease-resistant, self-topping variety, with large, solid, smooth fruits of light scarlet color. Pkt. 25c, oz. 75c.

Rutgers (Certified). A wilt-resisting variety. The fruits are deep red, globe-shaped; size, medium to large; flesh, firm and of excellent flavor. Pkt. 15c, oz. 75c, ¼ lb. \$2.25.

Scott's Ellenbank. A very large cropper, carrying trusses from 3 to 4 lbs. One of the best Tomatoes for indoor or outdoor cultivation. Pkt. \$1.00.

Stirling Castle. This is one of the best for indoor culture. Round, smooth, delicious flavor. Pkt. 25c, ¼ oz. \$1.00, oz. \$3.00.

Stone, Livingston's. Large, bright scarlet, solid, smooth, later than many, very productive. Pkt. 10c, oz. 40c, ¼ lb. \$1.50.

Turnip

One ounce will sow 150 feet of drill; 1½ lbs. per acre.

Turnips do best in highly enriched, light, sandy or gravelly soil; sow the earliest varieties soon the ground can be worked in the spring, in drills 12 to 13 inches apart. Seed can also be sown broadcast, using 3

pounds to the acre for fall and winter use. Swedish or Rutabaga Turnips are largely grown for a farm crop, as well as for the table; make sowings from the 10th of June until the last of July, in drills 2 to 3 feet apart.

Extra Early Milan, White. A beautiful early variety with small tops, tender and sweet. Pkt. 10c, oz. 20c, ¼ lb. 50c.

Golden Ball. Bulb of fine form and bright yellow color, a fine keeper; unsurpassed for table use. Pkt. 10c, oz. 20c, ¼ lb. 50c, lb. \$1.25.

Milan Early, Purple Top. The earliest of the white flesh varieties. Pkt. 10c, oz. 20c, ¼ lb. 50c.

Purple Top Strap Leaf. A well known variety, extensively grown both for table and for stock. Pkt. 10c, oz. 20c, ¼ lb. 50c, lb. \$1.25.

Purple Top White Globe. A handsome, globe shaped variety, valuable for market purposes. Pkt. 10c, oz. 20c, ¼ lb. 50c, lb. \$1.25.

Purple Top Yellow Scotch. The most popular of all the yellow-fleshed varieties. Grows to a good size, keeps well. Flesh firm and of good quality. Pkt. 10c, oz. 25c, ¼ lb. 75c.

White Egg. Oval shaped variety for spring or fall sowing; flesh white, firm, fine-grained, mild and sweet. Pkt. 10c, oz. 20c, ¼ lb. 50c, lb. \$1.25.

Yellow Aberdeen. Hardy, productive and a good keeper; yellow, flesh firm, good for table use or feeding stock. Pkt. 10c, oz. 20c, ¼ lb. 50c, lb. \$1.25.

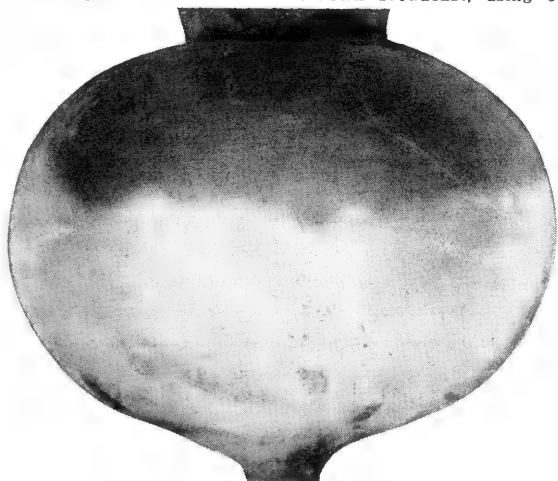

Purple Top Strap Leaf Turnip

Rutabaga or Swedish Turnip

Improved American, Purple Top. A yellow-fleshed, purple top variety grown for stock or table. Pkt. 10c, oz. 15c, $\frac{1}{4}$ lb. 40c, lb. \$1.00.

Monarch. A deep yellow fleshed, purple top variety, smooth, oval form, slightly tapering at ends; small neck and fine for table use. Pkt. 10c, oz. 15c, $\frac{1}{4}$ lb. 40c, lb. \$1.00.

Shamrock. An excellent variety; desirable either for stock or table use. Pkt. 10c, oz. 15c, $\frac{1}{4}$ lb. 40c, lb. \$1.00.

White French. Oval in form, clear white flesh; one of the best winter Turnips. Pkt. 10c, oz. 15c; $\frac{1}{4}$ lb. 40c, lb. \$1.00.

Macomber. The flesh is white, fine grained and of a mild sweet flavor! They will keep all winter and remain in fine condition for the table if properly stored. Pkt. 10c, oz. 25c, $\frac{1}{4}$ lb. 75c.

Pot, Sweet, and Medicinal Herbs

Plant in the spring when the ground is warm, in drills, covering lightly. When the plants are well up, thin out or transplant to about 4 inches apart. They should be harvested on a day just before the blossom develops, dried quickly and bottled, or closely packed in dry boxes with the air entirely excluded.

Anise (*Pimpinella anisum*). Annual. Used for flavoring and garnishing. Pkt. 10c, oz. 30c.

Arnica (*Arnica montana*). Perennial. Used in medicine as a narcotic and stimulant. Pkt. 10c, oz. \$2.00.

Balm (*Melissa officinalis*). Perennial. Leaves have a fragrant odor and are used medicinally. Pkt. 10c, oz. \$1.00.

Basil, Sweet (*Ocimum basilicum*). Annual. Used for flavoring soups, stews, etc. Pkt. 10c, oz. 30c.

Borage (*Borago officinalis*). Annual. Leaves are used for flavoring and bees are attracted by the flowers. Pkt. 10c, oz. 40c.

Caraway (*Carum carui*). Perennial. Used for flavoring confectionery, bread, etc. Pkt. 10c, oz. 30c.

Catnip (*Nepeta cataria*). Perennial. Sometimes used in medicine. Pkt. 10c.

Coriander (*Coriandrum sativum*). Annual. Used in the manufacture of confectionery and liquors. Pkt. 10c, oz. 30c.

Dill (*Anethum graveolens*). Biennial. The seeds are aromatic and pungent. Used in pickling cucumbers. Pkt. 10c, oz. 50c.

Fennel, Sweet (*Anethum foeniculum*). Perennial. Leaves when boiled are used in sauces. Pkt. 10c, oz. 50c.

Fennel, Florence (*Anethum foeniculum*). The roots are boiled, also used as salad. Pkt. 10c, oz. 50c.

Horehound (*Marrubium vulgare*). Perennial. Used medicinally, also for seasoning. Pkt. 10c, oz. 50c.

Hyssop (*Hyssopus officinalis*). Perennial. Used medicinally. The leaves have a pungent taste. Pkt. 10c, oz. 60c.

Lavender (*Lavandula vera*). Perennial. Yields an oil used in medicine and perfumery. Pkt. 10c, oz. \$1.00.

Lovage (*Levisticum officinale*). Perennial. An aromatic stimulant used in medicine. Pkt. 10c, oz. \$1.00.

Marjoram, Sweet (*Origanum majorana*). Annual. Aromatic and fragrant. Much used in flavoring. Pkt. 10c, oz. 80c.

Pennyroyal (*Hedeoma pulegioides*). Annual. An aromatic medicinal herb. Pkt. 10c, oz. \$1.00.

Rosemary (*Rosmarinus officinalis*). Perennial. Leaves fragrant, with warm, pungent, bitterish taste. Pkt. 10c.

Rue (*Ruta graveolens*). Perennial. Has a strong, heavy odor and bitter taste. Used medicinally. Pkt. 10c, oz. \$1.25.

Saffron (*Carthamus tinctorius*). Annual. Flowers are used as a dyestuff and in making rouge. Pkt. 10c.

Sage (*Salvia officinalis*). Perennial. More used than any other herb for dressings and seasoning. Pkt. 10c, oz. 50c.

Sorrel (*Rumex crispus*). Perennial. Used for salads or cooked and served as Spinach. Pkt. 10c, oz. 50c.

Summer Savory (*Satureia hortensis*). Annual. Used for flavoring soups and dressings. Pkt. 10c, oz. 25c.

Thyme (*Thymus vulgaris*). Perennial. Used for seasoning. Also used medicinally. Pkt. 10c, oz. \$1.25.

Wormwood (*Artemisia absinthium*). Perennial. Used medicinally and is beneficial for poultry. Pkt. 10c.

PLANTS OF HERBS—To meet the increasing demand for plants of the most popular herbs, we can supply 3 plants for \$1.25, 10 for \$3.50. Not less than 3 of one variety sold.

Vegetable Roots and Plants

We do not send Vegetable Plants by mail except where noted.

ASPARAGUS. Selected Roots.	100	1000
Martha Washington	\$2.00	\$18.00
Mary Washington	2.25	20.00

ARTICHOKE, Jerusalem. Qt. 40c, by mail 10c additional; pk. \$2.50.

CHIVES, Roots. 30c per clump, 12 clumps, \$3.00. By mail, add 10c extra for each clump.

	Each	Doz.	100
HORSE-RADISH. Sets or cuttings		\$0.35	\$1.75
MENT ROOTS25	2.50	18.00
RHUBARB ROOTS.			
Victoria. Largest variety35	3.00	
Champs75		
TARRAGON PLANTS (<i>Estragon</i>)50	5.00	

Tobacco

Connecticut Seed-leaf. Suited to the climate of the Northern and Middle States. Pkt. 10c, oz. 75c.

Havana, Imported Seed. Pkt. 10c, oz. 75c.

Free Delivery

IN GREATER BOSTON we deliver, Free of Charge, all merchandise purchased at retail catalog prices at our option.

Lawn Grass Seed Grey's Tested & Approved Dependable Mixtures

The following directions may be useful to those who are not familiar with lawn making.

The soil should be of good depth, moderately rich, the land should be carefully drained, and the soil thoroughly pulverized. Some good fertilizer—pure ground bone, wood ashes, or a specially prepared lawn fertilizer—should be used. After sowing, the ground should be lightly raked and rolled.

The selection of seed is important. Use only such mixtures as are free from weed seeds, and such as will produce a firm, strong turf and a fine growth. A liberal quantity is necessary to secure good results (not less than 64 pounds per acre). The best time to make a lawn is from the middle of August through September. If seed is sown at this season, the grass will become strong enough to withstand the winter, and a good lawn is assured the following season.

Grey's Special Lawn Grass Seed---Recleaned

In recommending this grade to our customers we are recommending a mixture which cannot be excelled for general lawn purposes. Sow 64 lbs. per acre. 1 lb., 60c, 5 lbs. \$2.75, 10 lbs. \$5.00, bu. (32 lbs.) \$14.00, 100 lbs. \$40.00.

GREY'S SPECIAL BENT GRASS MIXTURE. A combination of Bent grasses and red top which will produce a turf much finer in texture than a lawn of the ordinary type. Lb. \$1.25, 5 lbs. \$5.00, 10 lbs. \$9.50, 25 lbs. \$22.50.

GREY'S GRASS MIXTURE FOR SHADED LAWNS. Fine grasses selected especially for locations partially shaded by buildings or trees. Lb. 70c, 5 lbs. \$3.25, 10 lbs. \$6.00, 25 lbs. (1 bu.) \$13.75, 100 lbs. \$50.00.

GREY'S BANK AND TERRACE GRASS MIXTURE. This mixture is composed of deep rooting varieties which will give satisfactory results on steep inclines or terraces. Lb. 60c, 5 lbs. \$2.75, 10 lbs. \$5.00, 20 lbs. (1 bu.) \$8.50, 100 lbs. \$40.00.

GREY'S NO. 2 LAWN GRASS MIXTURE. To meet the requirements of those desiring a moderate-priced lawn seed, and suitable for various soils. This mixture is composed of such varieties as to produce a permanent, heavy turf. Lb. 40c, 5 lbs. \$1.75, 10 lbs. \$3.00, 25 lbs. \$7.00, 100 lbs. \$25.00.

Purity - Quality - Dependability--- Customer's Own Grass Seed Mixtures

Our aim is purity, quality and service. We are pleased at all times to quote prices on special grass mixtures, and for those wishing mixtures of their own formula, we will either ship the varieties separate, or mix them to the customer's instruction.

Special Mixtures for Tennis Courts, Golf Links, Etc.

The following mixtures used on many prominent golf courses, etc., in this vicinity, have given entire satisfaction.

Fair Green Mixture. For general use on golf links. Per lb. 50c, 100 lbs. \$45.00.

Putting Green Mixture. A combination of grasses best suited to produce a close, firm and lasting turf which will endure frequent cutting. Lb. 75c, 5 lbs. \$3.50, 10 lbs. \$6.50, 100 lbs. \$55.00.

Tennis Court Mixture. A mixture of fine grasses especially adapted to tennis courts, which will bear trampling without injury. Lb. 60c, 5 lbs. \$2.75, 10 lbs. \$5.00, 100 lbs. \$40.00.

Ball Grounds Mixture. This mixture is used by both the Leagues in Boston with the most satisfactory results. Lb. 45c, 10 lbs. \$3.75, 100 lbs. \$35.00.

Bowling Green Mixture. Mixture of fine, hardy grasses especially adapted for bowling greens. Lb. 60c, 5 lbs. \$2.75, 10 lbs. \$5.00, 100 lbs. \$40.00.

Seashore Lawn Grass Mixture. A mixture of fine grasses selected for their deep rooting qualities. Lb. 60c, 5 lbs. \$2.75, 10 lbs. \$5.00, 32 lbs. (1 bu.) \$14.00, 100 lbs. \$42.00.

PRICES SUBJECT TO CHANGE WITHOUT NOTICE.

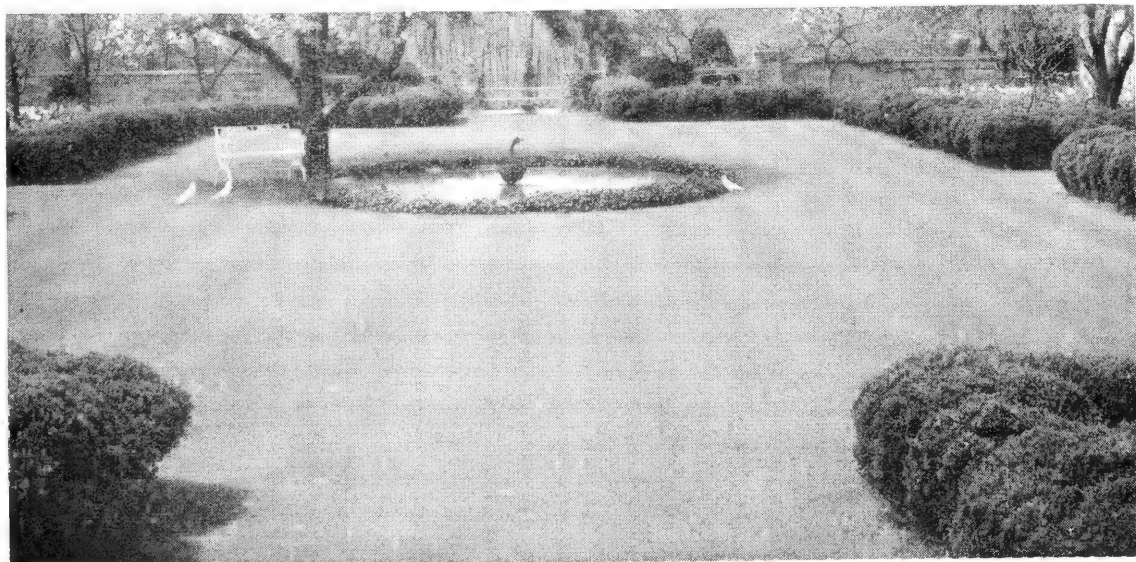



Choice Grass Seeds

All strictly Re-cleaned and Carefully Tested for Purity and Germination.

All grasses sold f.o.b. Boston. Bags extra. Prices subject to market changes. Samples sent on request.

Many growers of grass seeds offer several grades of each variety, varying greatly in price. We do not recommend nor do we sell the inferior grades. Those which we offer are strictly high grade, and the prices at which we offer them should not be compared with those quoted for inferior grades.

Free Delivery. We will prepay Parcel Post charges on cash orders at quoted catalogue prices on Grass Seeds, up to two pounds, anywhere in the United States, east of the Mississippi River; for larger quantities, the purchaser pays transportation charges.

Chewing's New Zealand Fescue. A splendid grass of creeping habit, forming a close and lasting turf. An excellent grass for golf courses. Lb. 90c, 100 lbs. \$85.00.

Crested Dogtail (*Cynosurus cristatus*). Good for permanent pasture; is productive and early. 35 lbs. to the acre. Lb. 55c, 100 lbs. \$50.00.

Fine-Leaved Fescue (*Festuca tenuifolia*). Its dwarf habit and fineness of leaf render it suitable for dry slopes on lawn. Weight 22 lbs. per bu. Lb. 85c, 100 lbs. \$80.00.

Italian Rye Grass (*Lolium italicum*). Valuable for mixing with other pasture grasses; sow 50 lbs. to the acre. Lb. 25c, 100 lbs. \$20.00.

Kentucky Blue (*Poa pratensis*). For pasture and lawns it has no superior; although slow to establish itself, once a stand is had, its creeping roots will form a close and lasting turf; usually sown with other grasses. Weight 14 lbs. per bu. Lb. 40c, 100 lbs. \$35.00.

Meadow Fescue (*Festuca pratensis*). One of the best grasses for permanent pasture. Sow 40 lbs. per acre. Lb. 30c, 100 lbs. \$25.00.

Orchard (*Dactylis glomerata*). One of the earliest grasses; and is excellent for pasture or hay. Sow 40 lbs. per acre. Lb. 30c, 100 lbs. \$25.00.

Perennial Rye Grass (*Lolium perenne*). Valuable where mixed with other grasses for lawns golf links, etc. Lb. 25c, 100 lbs. \$20.00.

Red Top (*Agrostis vulgaris*). Invaluable for lawn seed mixture.

Unhulled Seed. 10 lbs. per bu. Lb. 15c, 100 lbs. \$10.00.

Fancy Re-cleaned Seed. Absolutely clean and free from chaff. 36 lbs. per bu. Lb. 25c, 100 lbs. \$20.00.

Red, or Creeping Fescue (*Festuca rubra*). A creeping rooted grass forming a close and lasting turf. Lb. \$1.00, 100 lbs. \$95.00.

Rough Stalked Meadow Grass (*Poa trivialis*). It thrives on moist, rich soils and in sheltered situations. Lb. 55c, 100 lbs. \$50.00.

Sheep's Fescue (*Festuca ovina*). This is especially valuable as it thrives on poor, light or gravelly soils. 16 lbs. per bu. Lb. 60c, 100 lbs. \$55.00.

Sweet Vernal, True Perennial (*Anthoxanthum odoratum*). Useful to mix with other grasses, and the fragrant odor which it imparts when drying. Lb., \$1.50.

Tall Fescue (*Festuca elatior*). Succeeds best on moist, alluvial and strong, clayey soils. Lb. 45c.

Tall Meadow Oat Grass (*Avena elatior*). This grass produces an abundant supply of foliage, and is valuable for pasture. Lb. \$1.50.

Timothy, "Herd's Grass" (*Phleum pratense*). It is generally sown with Red Top and Red Clover, and makes the most valuable hay. 45 lbs. per bu. Lb. 12c, 100 lbs. \$10.00.

NOTICE. We are pleased at all times to quote prices on special grass mixtures, and for those wishing mixtures of their own formula, we will either ship the varieties separate, or mix them to the customer's instruction.

All prices subject to change without notice.

Bent Grasses for Lawns and Putting Greens

The various Bent Grasses have come into wide use for lawns and putting greens as they thrive in nearly all soils and produce a low, velvety sward of handsome, velvety texture.

Colonial Bent. A fine, hardy, very compact grass; very permanent, readily forming a heavy sward. Per lb. \$1.00.

Creeping Bent (Agrostis stolonifera). One of the most valuable lawn grasses because of its short growth and deep green, fine-leaved foliage. Its stoloniferous roots form a strong, close, enduring turf, which is not injured by being frequently walked on. Per lb. \$1.00.

German Mixed Bent (European agrostis). Makes beautiful thick velvety putting greens and lawns. Per lb. \$1.00.

Rhode Island Bent. Resembles Red Top but is of dwarfer habit. A fine, hardy, very compact grass; excellent for lawns. Sow 4 bus. per acre if alone. 14 lbs. per bu. Per lb. \$1.00.

Seaside Bent or Cocoos Bent (Agrostis stolonifera compacta; agrostis maritima). A creeping variety valuable for lawns and putting greens, producing a velvety turf of beautiful texture. Per lb. \$1.00.

Velvet Bent (Agrostis canina). A variety which is ideal for the finest lawns. This is the dwarfiest of the turf grasses. Per lb. \$.50.



INOCULATE ALL LEGUME SEEDS WITH

NITRAGIN

1898 — FORTY THREE YEARS OF SERVICE — 1941

When ordering, Always state name of seed.

ALFALFA, all Clovers

Size	Retail
1/2 bu. each.....	.30
1 bu. each.....	.50
2 1/2 bu. each.....	1.00

PEAS (All Varieties)

Size	Retail
1/2 bu. each.....	.25
1 bu. each.....	.35
1 1/2 bu. each.....	.55
5 bu. each.....	1.50
12 1/2 bu. each.....	3.60

BEANS

String, Wax, Kidney

1/2 bu. each.....	.25
1 bu. each.....	.35
5 bu. each.....	1.50

*The 30 bu. size as listed above is a carton which contains six 5 bu. size cans.

LESPEDEZA

Size	Retail
Small (Inoculates up to 50 lbs. seed)45
Large (Inoculates up to 100 lbs. seed)65

SOYBEANS, LIMA BEANS, COW PEAS, PEANUTS

Small (Inoculates up to 120 lbs. seed)30
*5 bu. each58
25 bu. (One can)	2.60
*30 bu. (6-5 bu. cans) ..	3.45

GARDEN SIZE

Garden Peas & Beans	
Sweet Peas & Lupines	
Enough for 6 lbs. seed	
Retail Price.....	10c each

BIRD SEEDS

(Prices subject to market fluctuations)

	Tb	100lbs
Canary Seed, Choice Re-cleaned	\$.015	\$12.00
Hemp Seed, Re-cleaned Russian15	12.00
Rape, Bird15	12.00
Rape, English20	18.00
Mixed Bird Seed. In bulk15	12.00
Rice, Unhulled, or Paddy20	15.00
Wild Bird Food Mixture15	12.00
Sunflower Seed20	15.00

All prices subject to change without notice.

Special Mixtures

For Permanent Hay

Sow 50 pounds to acre.

No. 1 for Cool, Moist Soils	100 lbs. \$30.00
No. 2 for High, Dry Soils	30.00
No. 3 for Wet Soils	30.00

For Permanent Pastures

Sow 50 pounds to acre.

No. 4 for Cool, Moist Soils	100 lbs. \$35.00
No. 5 for High, Dry Soils	35.00
No. 6 for Wet Soils	35.00

Clover Seeds

Prices subject to change with the market.

Alfalfa, Genuine Grimm. It originated in northern Minnesota. The strong branching roots of Genuine Grimm Alfalfa prevent winter-killing. Sow 15 to 20 lbs. per acre. Lb. 40c; 100 lbs. \$36.00.

Alsike, or Swedish (Trifolium hybridum). Hardest of all the Clovers, and on rich, moist soil yields an enormous quantity of hay or pasture. Valuable for sowing with Clovers or grasses, as it forms a thick bottom and increases yield of hay. Lb. 30c; 100 lbs. \$28.00.

Bokhara Clover (Melilotus alba). Valuable sort for soiling and for ensilage and bees. Grows from 3 to 5 feet high; sown in rich soil, may be cut three times; lasts for years if cut before flowering. 15 lbs. to the acre. Lb. 20c; 100 lbs. \$15.00.

Crimson Clover (Trifolium incarnatum). Sow in April or May; 20 lbs. to the acre. Not always hardy in New England. Lb. 20c; 100 lbs. \$18.00.

Red Clover, Medium (Trifolium pratense). The leading variety of Clover for pastures or meadows. Requires deep rich soil. Sow in spring. Lb. 30c; 100 lbs. \$28.00.

Red Clover, Mammoth. Grows 4 to 5 ft. high, and is used to plow under for manure. Lb. 30c; 100 lbs. \$28.00.

White Dutch Clover (Trifolium repens). The best variety for lawns, as it forms a close herbage and remains green throughout the season; valuable when mixed with grass seeds for pasture. Lb. \$1.25.

Farm and Field Seeds

All Farm and Field Seed prices subject to change without notice.

Barley

48 lbs. to the bushel; 2 bushels to the acre.

	Peck	Bushel
Four or six-rowed	\$1.00	\$3.00
Two-rowed	1.00	3.00

Before planting Beans,
inoculate seed with—



Beans

Sow 1 bushel to the acre.

Yellow Soja. A large-growing, yellow-seeded variety, especially suitable for ensilage and plowing under. Pk. \$1.00, bu. \$2.25.

Itto San. An early, small-leaved variety recommended for latitudes having short season, especially New England. Pk. \$1.25, bu. \$4.00.

Wilson. A rank-growing variety, branching high, leaves large, both pods and leaves remaining on vines long after cutting. Pk. \$1.00, bu. \$3.25.

Beets, Mangel Wurzel

Sow 6 to 8 pounds to acre.

Danish Sludstrup. A long, reddish yellow variety. Lb. 75c, 10 lbs. \$6.00.

Golden Tankard. An enormous yielder per acre. Flesh deep yellow. Lb. 75c, 10 lbs. \$6.00.

Mammoth Long Red. The largest and heaviest cropper of all the Mangels. Lb. 75c, 10 lbs. \$6.00.

Buckwheat

48 pounds to the bushel. Sow 1 bushel to the acre.

Japanese. Very prolific. Pk. \$1.00, bu. \$2.50.

Field Corn

Plant 8 to 12 quarts per acre in hills; for fodder or ensilage, in drills, 1 to 1½ bushels per acre; and for silage, 3 to 4 bushels per acre, broadcast.

Flint Varieties

Early Canada. One of the earliest yellow varieties; ear small; in ordinary seasons the crop will be fully ripened in August. Pk. \$1.25, bu. \$4.00.

Longfellow. The standard variety in this section; long ears, small cob, bright yellow color, and medium early. Pk. \$1.25, bu. \$4.00.

Dent Varieties

Leaming. Yellow Dent variety, with large, deep grain of dark orange color; excellent for ensilage. Pk. 85c, bu. \$2.50.

Pennsylvania Sweepstake Corn. This variety of corn will mature quicker than any other variety. Pk. \$1.50, bu. \$4.50.

Pride of the North. The earliest Yellow Dent Corn in cultivation. Pk. \$1.00, bu. \$3.00.

Fodder and Ensilage Varieties

Eureka. Grows from 10 to 15 ft. high and produces a rich, heavy growth. Pk. \$1.00, bu. \$3.00.

Evergreen Sweet Fodder. For cutting green and feeding to stock this variety excels all others. Pk. \$2.50, bu. \$9.00.

Millet

German, or Golden. A valuable annual hay and fodder crop, more productive and coarser than the Hungarian. Sow 1 bushel to the acre. Pk. \$1.25, bu. \$4.00.

Japanese (Panicum Crus-galli). If sown early and cut, usually produces a good second crop. Sow 20 lbs. per acre. Lb. 12c, 100 lbs. \$10.00.

Hungarian Millet (Panicum germanicum). An annual forage plant, early and productive. Sow 1 bushel to the acre. Pk. \$2.25, bu. \$4.00.

Oats

Sow 2 to 3 bushels to the acre, 32 pounds to the bushel. **Canadian Cluster.** Heavy, with stiff straw; yields well. Pk. 40c, bu. \$1.25.

Welcome. A very productive white variety, with extra strong, straight straw. Pk. 40c, bu. \$1.25.

Before planting Peas,
inoculate seed with—



Peas

Canada Field. Valuable when sown with Oats as a green fodder. Also makes good ensilage. Sow 2 bushels Oats and 1 bushel Peas per acre. Pk. \$1.75, bu. \$6.00.

Clay or Wonderful. Sow as early as May 10th or as late as July 1st, 1 bushel to the acre in drills; 2½ bushels to the acre broadcast. Pk. \$1.25, bu. \$4.00.

New Era. Early and large yielder. Pk. \$1.25, bu. \$4.00.

Whippoorwill. One of the earliest. Pk. \$1.25, bu. \$4.00.

Rape

50 pounds per bushel

Dwarf Essex. Fine for sheep pasture; valuable as a soil enricher. Plant in June or July in drills at the rate of 3 lbs. per acre. broadcast 5 lbs. per acre. Lb. 20c, 100 lbs. \$18.00.

Rye

Sow 1½ bushels per acre (56 lbs. per bu.).

Rosen Winter Rye. The most desirable variety for northeast conditions, either summer or autumn planting. Pk. 75c, bu. \$2.50.

Spring Rye. Selected re-cleaned grain in limited supply. Pk. 85c, bu. \$3.00.

Sorghum

Sow 25 pounds per acre in drills; for dry fodder, broadcast 100 pounds per acre.

Early Amber Sugar Cane. Will ripen where Indian corn matures. Lb. 25c, 100 lbs. \$20.00.

Red Kaffir Corn or Sorghum. Non-saccharine. The plants cure into excellent fodder, or may be fed green during all stages of growth. Lb. 20c, 100 lbs. \$12.00.

White Kaffir Corn. Lb. 20c, 100 lbs. \$12.00.

Sudan Grass

Sown broadcast use 16 to 24 pounds of seed per acre; if planted in drills, 18 to 21 inches apart, from 4 to 6 pounds per acre will be sufficient. Lb. 15c, 100 lbs. \$10.00.

Sunflower

Sow 6 to 8 pounds per acre (25 pounds per bushel).

Mammoth Russian. Very productive, large heads with large seeds. Valuable for poultry. Lb. 20c, 100 lbs. \$15.00.

Before planting Vetches,
inoculate seed with—



Vetches or Tares

Weight, 60 pounds per bushel.

Vetches or Tares, Spring (Vicia sativa). Frequently sown with oats. Sow 1-1½ bus. per acre. Pk. \$1.75, bu. \$6.00.

Vetches, Sand, Winter, or Hairy (Vicia villosa). Thrives on poor, arid, sandy soil, and can be sown either in spring or fall. Sow 40 to 50 pounds per acre. Pk. \$2.75, bu. \$10.00.

Wheat

Sow 1½ bushels per acre (60 pounds per bushel).

Spring (Marquis). Pk. \$1.00; bu. \$3.00.

Winter (Klondyke Bald). White grain. Pk. \$1.00; bu. \$3.00.

All Grains sold f. o. b. Boston. Bags extra. Prices subject to market changes. Sample sent on request.



Lilium Speciosum Rubrum

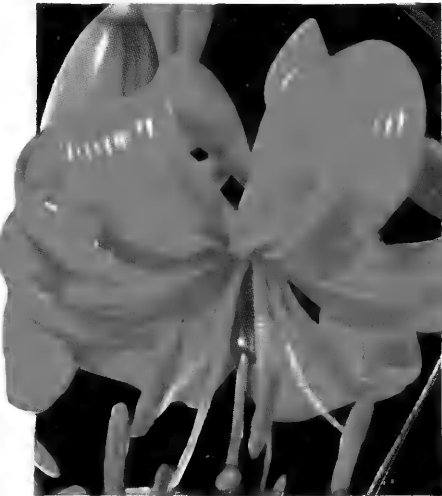

Lilium Tenuifolium
Very Colorful and Decorative

LILY-OF-THE-VALLEY

(Convallaria)

Grey's Perfect Forcing Pips. The finest grade of Pips that come to this country and especially selected for our large private trade, which demands only the best for forcing throughout the year. We carry these in cold storage and can furnish them at any time. Three to four weeks are usually allowed for forcing cold storage Pips into flower. Case of 100, \$9.50; case of 250, \$20.00.

Lilies = 10 Best Varieties

- Auratum** (Golden Rayed Lily of Japan). Large, pure white flowers, with crimson spots and a golden band through the center of each petal. 2 to 4 ft. high, blooming from July to October. Mammoth bulbs. Doz., \$5.00; 100, \$40.00.
- Hansoni.** Delicately nodding flowers of pale yellow-orange, with thick, waxy, recurved petals, in clusters above broad whorls of leaves on stems 2 to 4 ft. high. Blooms in June. Doz., 40c; 100, \$4.00.
- Henryi** (Yellow Speciosum). A beautiful Lily from China. Rich apricot-yellow, reddish brown spots. 5 ft. July and August. Each, 40c; doz., \$4.00.
- Krameri.** Beautiful, delicate pink. Fragrant trumpet-shaped flowers. 3 ft. July and August. Doz., \$3.50.
- Speciosum album.** Large, fragrant, pure white. Each, 45c; doz., \$4.50; 100, \$35.00.
- Speciosum magnificum.** Rich red, heavily spotted; much larger and richer colored than the other varieties. Mammoth bulbs. Each, 40c; doz., \$4.00; 100, \$30.00.
- Speciosum Melpomene.** White, shaded with rich blood-crimson; heavily spotted. Mammoth bulbs. Each, 40c; doz., \$4.00; 100, \$30.00.
- Speciosum rubrum or roseum.** White shaded and spotted rosy crimson; fragrant. Mammoth bulbs. Each, 40c; doz., \$4.00; 100, \$30.00.
- Regale** (Regal Lily). White, slightly suffused with pink, with a beautiful shade of canary-yellow at the center of the trumpet. Mammoth bulbs. Doz., \$4.50; 100, \$35.00.
- Tenuifolium.** Bright scarlet flowers and recurved petals. Excellent for rockeries and pot culture. Early June. Height about 18 inches. Doz., \$1.50; 100, \$12.00.



Lilium Regale

Gladiolus ~

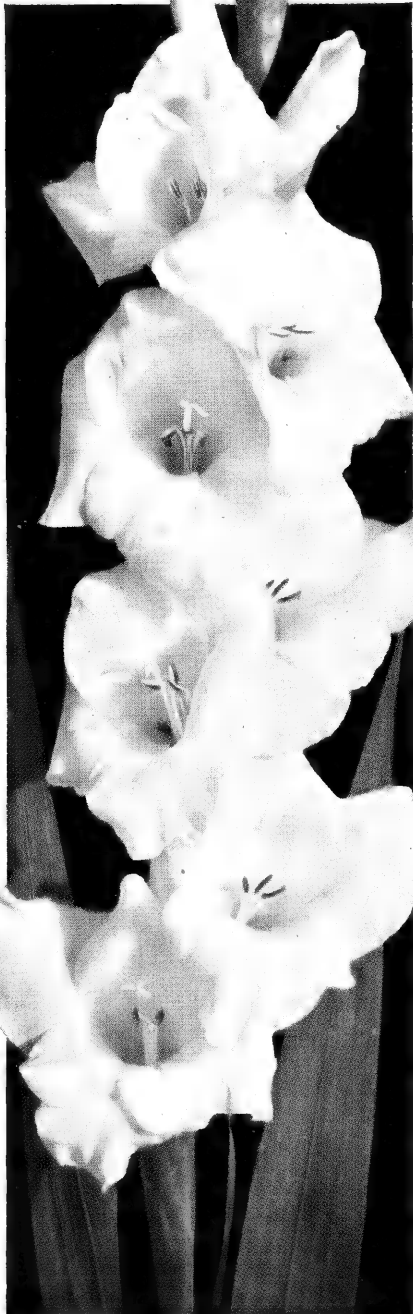

For general garden decoration and cut flowers the Gladiolus is deserving of special attention. Very effective for massing in large beds where a brilliant effect is desired. Of easiest culture, seldom disappointing and immune to insect pests. They thrive in well prepared, enriched loam, planted 3 inches deep and 6 inches apart. Frequent watering is very beneficial. We stock first size bulbs only. Six bulbs offered at the dozen rate.

	Doz.	100
Aida. Striking dark blue, small reddish throat blotches. Very early	\$.65	\$4.75
Albatross. Very large pure white on tall spike of good standing60	4.50
Amador. Very large florets. Color deep scarlet-red with carmine throat marking70	5.00
Ave Maria. One of the older blues that make this an outstanding variety, and still holds its place as one of the best60	4.50
Bagdad. Very large, smoky old rose, lighter throat55	4.00
Blue Danube. A lovely amethyst-blue with darker blotches. Exceedingly attractive70	5.00
Christabel. Shrimp-pink with yellow throat. Several large florets open80	6.00
Commander Koehl. Dark scarlet without markings. Florets very large70	5.00
Coryphee. Beautiful pink, similar to an Ophelia rose ..	.70	5.00
Crimson Glow. Deep crimson, lighter in throat. Exhibition variety55	4.00
Debonair. A striking LaFrance-pink with throat of shrimp-pink and cream. A very good variety60	4.50
Dr. F. E. Bennett. A very large, fiery red. Considered Diener's best red60	4.50
Edith Robson. An exhibition type. Peach with carmine blotch on yellow throat70	5.00
E. I. Farrington. A very beautiful rich self flower. Many florets of fair size open at one time. One of the most popular yellows60	4.50

GLADIOLUS By F. F. Rockwell

We highly recommend this book to anyone interested in this popular flower.

\$1.25 per Copy

Maid of Orleans Gladiolus
Description on page 69.

Leading Gladiolus-Recommended by Grey's

Top Size Bulbs Only—Your Assurance of the Best Flower Spikes

	Doz.	100		Doz.	100
Giant Nymph. A giant in growth and flowers. Light rose-pink with creamy yellow throat	\$0.55	\$4.00	Smiling Maestro. Rich orange-salmon. Flowers of unusual size	\$0.85	\$6.00
Gloriana. A very fine large salmon, with yellow throat. No other markings55	4.00	Symphony. Tall spikes of lovely delicate pink blooms with a cream blotch70	5.00
Golden Dream. Clear deep yellow; flowers recurved and distinct55	4.00	Wasaga. Clear apricot, with buff throat ..	.60	4.50
J. S. Bach. Outstanding variety. The florets are glorious orange-salmon shaded lighter at the throat	1.00	7.00			
King Arthur. Large rosy lavender flowers, beautifully fluted and ruffled70	5.00			
Loyalty. Large, ruffled, deep golden yellow70	5.00			
Maid of Orleans. A beautiful milky white, with light cream throat. Extra tall spike	.60	4.50			
Mammoth White. Immense white. Fine exhibition variety with very large florets.	.60	4.50			
Morocco. A very deep red, toning toward black; excellent for bouquets.	.70	5.00			
Miss Bloomington. A grand very early tall light yellow, 4 to 6 well placed blooms open at a time60	4.50			
Mother Machree. Beautiful combination of wine-tinted lavender, overlaid with salmon-pink65	4.75			
Minuet. New self colored lavender; rich, very large flower of heavy substance ..	.70	5.00			
Mrs. P. W. Sisson. One of the best creamy, light pink varieties60	4.50			
Orange Princess. A ruffled variety of a beautiful salmon-orange with small crimson feather	1.00	7.50			
Pelegrina. The newest and best of dark blues. Very tall grower60	4.50			
Picardy. One of the most outstanding varieties in existence. Soft shrimp-pink, with flesh-pink lip. Blotch of light flesh-pink shading to shrimp-pink at edges. Well placed on tall, strong spike50	3.50			
Polar Ice. Large size florets of pure white, long spikes70	5.00			
Rideau. A smoky salmon, 6 to 8 blooms, on a medium spike	\$0.75	\$5.50			

Primulinus Varieties

Cut-Flower Novelties

The following list of Primulinus we highly recommend. The colors are mostly yellows, oranges, pinks, etc., and they are specially desirable as cut flowers for vase work.

	Doz.	100
Aflame. An outstanding red Primulinus variety. Enormous flowers on tall spike.	\$0.55	\$4.00
Betty Co-ed. Soft creamy pink. Several fan-sized florets open at a time60	4.50
Brightside. Canary-yellow flushed apricot in throat, orange tipped70	5.00
Orange Butterfly. Dainty orange-yellow throat blotches, tall with many florets. Unusual coloring75	5.50
Seafoam. White Primulinus. Pure white with greenish reflex. Good spike60	4.00
Mixture. Containing a fine collection of popular named varieties50	3.50

Prize Garden Mixture

Our choicest mixture, selected from the newer and better varieties, including only colors which harmonize well together.

Doz., 75c; 100 for \$4.75.

Home Garden Mixture

A superior mixture including all colors and types.
Doz., 50c; 100 for \$3.00.

OUR GLADS ARE FREE FROM THRIP!

Due, no doubt, to scientific treatment of planting stock for the past seven years our Gladioli have always been free from thrip. As an added precaution and to be sure that bulbs supplied by us are absolutely free from this pest, we will also scientifically treat our bulbs again before shipment is made to our customers.

Inasmuch as thrip lives in the soil, as well as on the bulbs in storage, through the winter, it is imperative that our bulbs be planted on soil where Gladioli were not grown last year and not close to other Gladioli from other sources.

The World-
Renowned
Picardy
at 1941
Low Prices

SUMMER FLOWERING BULBS

Acidanthera

Bicolor. A summer flowering bulb, having beautiful, creamy white, fragrant flowers with a purple-maroon blotch at base of petals. Doz. \$1.35, 100 \$10.00.

Begonias

Splendid pot plants for the house or greenhouse, and especially valuable for bedding, flowering in the greatest profusion throughout the summer. For bedding they should be started in hotbed in March and April.

Single Tuberous Rooted

Separate Colors. Crimson, rose, orange, pink, white, yellow, salmon, scarlet. Each 30c, doz. \$3.00, 100 \$22.00.

Double Tuberous Rooted

Separate Colors. Crimson, orange, rose, pink, white, yellow, salmon, scarlet. Each 30c, doz. \$3.00, 100 \$22.00.

Cannas, Dormant Roots

Large-Flowering French Mixed. Finest varieties. Each 12c, doz. \$1.25.

Dahlias

Special Dahlia Catalog mailed on application.

Gloxinias, Large Flowered

Delivered January.

Magnificent for house or conservatory, producing in great profusion flowers of the richest and most beautiful colors. They succeed best in sandy loam and peat, and require a moist heat.

Separate Colors. Dark purple, white with scarlet border, scarlet, rose, white with purple border. Each 50c, doz. \$5.00.

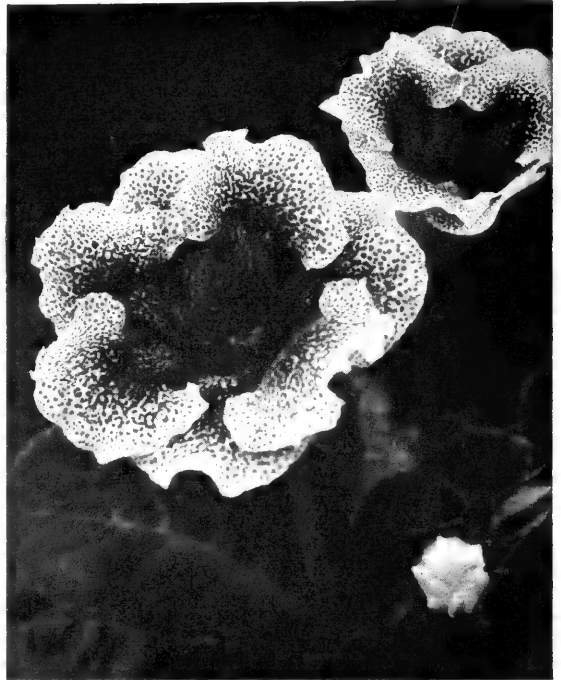

Gloxinia

Hyacinthus Candicans

A hardy summer-flowering Hyacinth with spikes of white bell-shaped flowers. Height 3 feet. Doz. \$1.50, 100 \$12.00.

Montbretias

One of the best and brightest summer-flowering bulbs, sure of becoming firm favorites wherever grown. Planted in clumps from April to June they produce numerous graceful spikes of brilliant star-shaped flowers. Hardy with protection.

Aurora. Golden orange with apricot shadings. Doz. \$1.00, 100 \$7.00.

Hereward. Late, large flowering, yellow, shaded orange on the outside. Doz. 80c, 100 \$6.00.

His Majesty. A vigorous new seedling with handsome foliage. Outside bright red, inside scarlet with yellow center. Doz. \$1.10, 100 \$8.50.

James Coey. Vermilion-scarlet with clear luster, center yellow with crimson blotches. Doz. \$1.75, 100 \$12.00.

Lord Nelson. Deep orange-scarlet, externally crimson, eye yellow. Doz. \$1.25, 100 \$9.00.

Nimbus. Golden, edged with a crimson ring around the base. Doz. \$1.25, 100 \$9.00.

Rosea. Clear pale pink. Doz. 80c, 100 \$6.00.

Una. Inside of flowers apricot. Outside red with crimson blotch in center. Doz. \$1.25, 100 \$9.00.

Tuberose

Delivered March

Double Excelsior Pearl. Summer flowering bulbs, producing tall spikes of fragrant, double white flowers. Start in pots in rich loam and transplant into the garden. Doz. \$1.35, 100 \$10.00.

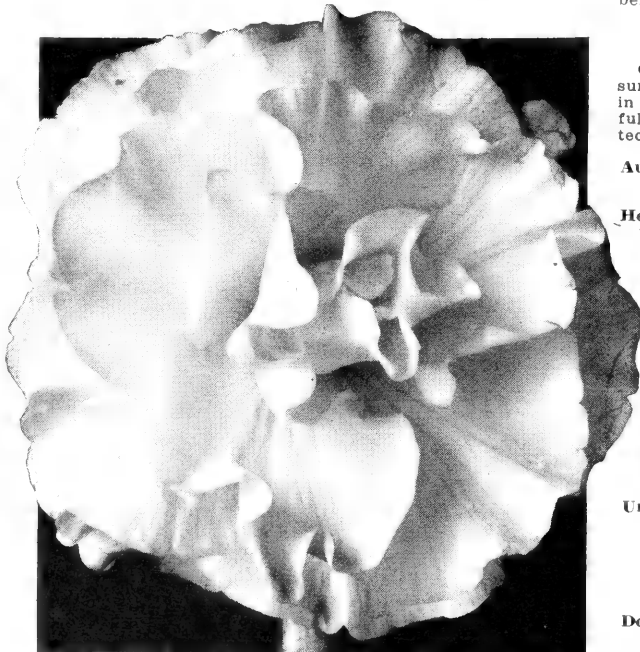

Double Flowering Tuberous Rooted Begonia



Verbena

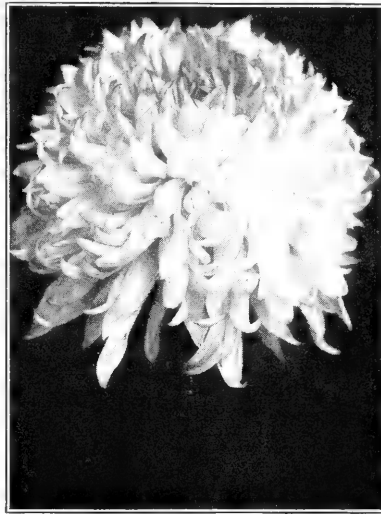

Chrysanthemums

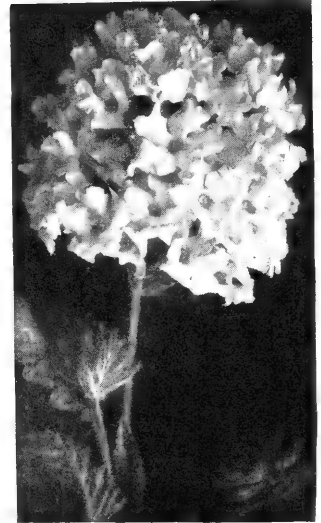

Asters

Foliage and Flowering Plants

For Summer Bedding

	Doz.	100
Abutilon	\$2.75	\$20.00
Alternanthera. Dwarf scarlet	1.50	10.50
Alternanthera. Dwarf yellow	1.50	10.50
Achyranthes. Bright crimson	1.50	10.00
Achyranthes. Green and white	1.50	10.00
Ageratum. Blue or white	1.75	13.50
Alyssum, Double White	1.25	8.50
Alyssum, Single White	1.00	7.50
Antirrhinum (Snapdragon). Assorted	1.75	13.50
Asters. Assorted colors. Double50	3.50
Asters. Double white50	3.50
Begonia. Tuberous-rooted mixed	4.00	31.50
Begonias. In variety	2.50	19.50
Caladium esculentum	6.00	40.00
Calendula, Orange King	1.50	10.00
Cannas, Dwarf Large-Flowering French	2.75	20.00
Cannas. In the following varieties: Ambassador, City of Portland, King Humbert, Yellow King Humbert, King Midas, Mrs. Alfred Conard, The President, Hungaria	2.75	20.00
Centaurea candidissima	1.50	10.00
Centaurea gymnocarpa	1.50	10.00
Chrysanthemums. Our collection of these beautiful fall-blooming plants embraces the best of the old and newer introductions	2.50	
Cobaea scandens	2.50	18.00
Coleus. Fine varieties	1.25	8.50
Cosmos. Early flowering	1.00	7.50
Daisy, Double English. Assorted70	5.00

	Doz.	100
Daisy, Paris Golden. Single yellow	\$3.00	\$23.00
Daisy, Paris White. Single white	3.00	23.00
Feverfew, Double White	1.75	12.50
Feverfew, Golden Feather	1.25	8.50
Fuchsia. In variety	3.00	23.00
Geranium, Double Varieties	3.00	23.00
Geranium, Single Varieties	3.00	23.00
Geranium, Ivy-Leaved Sorts	3.50	25.00
Heliotrope, Giant Elsa	2.75	22.00
Heliotrope, Dark and light	2.25	17.00
Lantanas. In variety	2.25	17.00
Lobelia. Dark blue, for bedding	1.25	8.50
Marigold, Dwarf French	1.25	8.50
Mignonette, Large-Flowered	1.00	7.50
Nicotiana affinis. White, fragrant	1.25	8.50
Nicotiana sanderae. Carmine	1.25	8.50
Fancy. Special strain, extra choice70	5.00
Petunia, Double. Assorted colors	2.25	17.00
Petunia, Single. Assorted colors	1.50	10.00
Phlox drummondii. Assorted	1.25	8.50
Ricinus (Castor-Oil Bean)	1.75	12.50
Salpiglossis. Mixed colors	1.50	10.00
Salvia splendens. Best scarlet	1.50	10.00
Torenia fournieri. Blue	1.50	10.00
Verbena. Assorted colors	1.50	10.00
Verbena. Lemon-scented	3.00	23.00
Vinca alba and rosea (Flowering Vinca)	1.25	8.50
Vinca variegata (Periwinkle). Trailing	2.50	19.00
Wallflower, Mixed	1.75	12.50
Zinnia, Columbia Prize. Assorted	1.00	7.50

PALMS, FERNS AND GREENHOUSE PLANTS.
Quotations on application.

Many other varieties not mentioned in this list can be furnished at regular prices.

Select List of Hardy Perennial Plants

We furnish a good selection of hardy plants, which may be expected to give successional bloom throughout the spring, summer and fall months, and, if the choice is left to us, will take special care to select such varieties as afford the most satisfactory results.

We also furnish estimates on the laying out, planting and improvement of private estates, and furnish experienced gardeners to carry out the work. We shall be pleased to correspond with those contemplating improvements in planting hardy stock of any sort.

PARCEL POST—Add six cents for one plant, two cents for each additional plant.

The prices of all the perennial plants on this and succeeding pages: 30c each, six of the same variety \$1.50, and twelve of the same variety \$2.50, except as otherwise noted.

ACHILLEA (Milfoil or Yarrow).
ptarmica fl. pl. var., **The Pearl**. Double white flowers, most useful for cutting. June to October.

ACONITUM napellus (Monkshood). Dark blue flowers from July to September. 3 ft. Each 35c.

fischeri. A dwarf variety with pale blue flowers. September. 18 in. Each 35c.

Sparks' Variety. The darkest blue of all. Flowers in June. Each 35c.

AJUGA genevensis (Bugle). 6 in. Blue. Excellent for rock work, covering banks and shady places. May.

ALYSSUM saxatile compactum (Basket of Gold). 1 ft. A grand plant for the rockery or border. April to June.

ANCHUSA italica, Dropmore Variety. 3 to 4 ft. A lovely shade of gentian blue, and blooms the entire season.

mysosidiflora (Forget-Me-Not Flowered Anchusa). Grows 12 inches high and is covered during April and May with sprays of rich blue flowers.

ANEMONE, japonica alba, 2 to 3 ft. Flowers large, white. One of the best. September to November.

japonica, Queen Charlotte, 3 ft. Large, semi-double, silvery pink. September.

japonica, Whirlwind, 3 to 4 ft. Large, semi-double, pure white. September.

hupehensis. Pink. September and October. 3 ft.

pulsatilla. Lilac-blue flowers early in spring, prefers dry location in full sun. Fine rock plant.

September Charm. New. Rosy pink flowers. September 15th. Erect habit and free flowering.

ANTHEMIS tinctoria (Golden Marguerite). 3 to 4 ft. Lemon-yellow. June to October.

AQUILEGIA (Columbine).

alpina. Dwarf, short-spurred, blue flowers.

Long-Spurred Hybrids, 2 ft. These embrace all the colors of the long-spurred type. May to July.

California Hybrids, 2 ft. Mixed colors. May.

caerulea (Rocky Mountain Blue Columbine). 3 ft. Long spurs, blue and white flowers. May to July.

Mrs. Scott Elliott Hybrids. Wonderful pastel colors with very long-spurred flowers.

ARABIS alpina (Rock Cross). 3 in. Early white spring-flowering plants. Fine for rock work. April to June.
alpina fl. pl. Double, white.

ARMERIA maritima (Sea Pink or Thrift). 1 ft. A fine plant for rockeries or edgings; flowers bright pink.

ARTEMISIA lactiflora (Wormwood). A tall growing plant of fine foliage and heads of small white flowers in August and September.

Silver King. White foliage. A fine filler for bouquets.

ASCLEPIAS tuberosa (Butterfly Weed). Very attractive native plants, flowering during July and August, and growing about 2½ ft. high. Umbels of bright orange-colored flowers.

ASTER (Michaelmas Daisies).

Beechwood Challenger. Red. 50c each.

Blue Gem. Double, dark blue. 4 to 5 ft. September.

Climax, 5 ft. Light bluish lavender. August to October.

Harrington Pink, 50c each.

Mt. Everest. Best white.

Mrs. Raynor. Red.

Peggy Ballard, 3 ft. Large double rosy mauve.

Queen Mary. Blue, tinted lavender. 2½ in. across. 3½ ft.

St. Egwin, 2½ ft. Bright pink. September and October.

Ypres. Rosy red. 3 to 4 ft.

ASTER (New Dwarf Varieties)

This collection will fill a long felt want in providing a race of dwarf, compact, free flowering plants blooming in September, at a season when there is a scarcity of low growing plants. Unsurpassed for borders and the Rock Garden.

Countess of Dudley. Clear pink with contrasting yellow eye. Bushy habit, free flowering and grows 18 inches high.

Lady Henry Maddocks. Pale pink. Flowers produced freely. Grows 12 inches high.

Marjorie. Compact habit, bearing large flowers of bright rose-pink.

Nancy. Bushy plants completely covered with pale flesh-pink flowers. Height 12 inches.

Ronald. Pleasing shade of bright lilac-pink following rose-pink buds. 12 inches high.

Victor. The most dwarf of all with clear lavender-blue flowers.

Any of the above \$0.35 each; \$3.50 per dozen.

AUBRIETIA (Rainbow Rock Cross). Dwarf, suitable for rockery. Sheets of various colored flowers in spring.

BAPTISIA australis (False Indigo). 3 ft. Long racemes of dark blue flowers. June to July.

BOLTONIA asteroides (False Chamomile). 3 to 4 ft. Fine late-flowering perennials. Aster-like white flowers. August and September.

latisquama, 4 ft. Flowers clear lavender; fine for cutting.

CAMPANULA carpatica (Harebell). 3 in. Erect blue flowers, useful for edgings. June to September.

carpatica alba, 3 in. Pure white.

medium (Canterbury Bells). 3 ft. Biennial. Flowers blue, white and rose. Separate colors. June and July.

medium calycanthema (Cup-and-Saucer). Biennial. Separate colors.

persicifolia (Bellflower). 2 ft. Blue. June to August.

persicifolia alba, 2 ft. White. June to August.

rotundifolia (Blue Bells). 1 ft. Blue. June to August.

CARNATIONS, Grenadin. Pink, Red and White. 12 in. June and July.

CENTAUREA montana. 20 in. Large purple flowers. June.

CERASTIUM tomentosum (Snow-in-Summer). 5 to 6 in. Low growing plant. Silvery foliage, white flowers.

CHELONE lyonii (Turtlehead). 2 ft. Showy deep red flowers, bearing Snapdragon-like blooms. August.

Hardy Perennial Plants

CHEIRANTHUS, Allioni. (Siberian Wallflower.) Brilliant orange flowers in June. 12 inches.

CHRYSANTHEMUMS (Hardy Garden Varieties)

- Coreanum** (Korean Chrysanthemum). 2 to 3 ft. September and October. A superb garden plant, coming into bloom before the first frosts. Flowers are single, 2 to 3 inches across, white at first, acquiring a rose-pink tinge.
- Aladdin.** Coppery bronze.
- Brown Bessie.** Pompon. Reddish bronze.
- Crimson Splendor.** Rich crimson-maroon. Late Sept.
- Early Snow.** White.
- Excelsior.** Bright yellow.
- Glory of Seven Oaks.** Large yellow. Early.
- Granny Scovill.** Large coral-bronze. Oct. 10.
- Jean Treadway.** Large pink. Early.
- L'Argenteuilais.** Deep chestnut. Early.
- Mrs. Nellie Kleris.** Deep pink. Early.
- Oconto.** Japanese. White. Large. October 15.
- Old Homestead.** Pink. Large.
- Ruth Hatton.** Rosy pink.
- Skibo.** Golden yellow. Pompon. October 20.
- Tennyson.** Large chestnut brown.
- Burbank's Shasta Daisy.** 1½ ft. Large snow-white flowers; blooms all summer.

NEW KOREAN CHRYSANTHEMUMS. A new distinct type of chrysanthemum that blooms earlier, adds new color and new hardiness. Can be used where winter killing has been a serious objection.

- Apollo.** Combination of bronze, red and gold.
- Ceres.** Combination of yellow and soft coppery bronze.
- Clio.** Dwarf habit, deep carmine rose.
- Daphne.** New shade of pink.
- Diana.** Rose pink and soft salmon.
- Fortuna.** Medium height, oxblood red.
- Hestia.** Semi-double rose pink.
- Juno.** Dwarf, single coppery red.
- Mars.** Deep amaranth red.
- Morifolium.** Pink.
- Niobe.** Dwarf, white with yellow discs.
- Psyche.** Medium height, shell pink.
- Sappho.** Dwarf, pure yellow.
- Thalia.** Medium height, bright orange.
- Vesta.** Deep golden orange.

COREOPSIS. One of the best blooming all-summer plants. Double-flowered yellow.

- lanceolata grandiflora.** 2 ft. Large golden yellow.

DELPHINIUM (Larkspur).
belladonna. 3 ft. Sky blue.
bellamosum. 3 ft. Dark blue.
chinense. 2 ft. Gentian-blue. Blooms all summer.
chinense album. 2 ft. White. Blooms all summer.
Choice Mixed English Hybrids.

DIANTHUS plumarius (Garden Pinks). A valuable and showy border plant; single and double. Very fragrant. May to August.
barbatus (Sweet William). 1 to 1½ ft. Mixed varieties. June and July.
deltoides (Maiden Pink). A dwarf trailer with rosy pink flowers. June to August.

DICTAMNUS fraxinella (Gas Plant). 2½ ft. Rosy crimson, fragrant foliage. May to July. 50c each.

DIELYTRA, or DICENTRA. A hardy perennial with heart-shaped rose-colored flowers in drooping spikes.

- Eximia.** Handsome, reddish purple flowers and delicate foliage. Plant about one foot high. May to August.
- Spectabilis (Bleeding Heart, or Seal Flower).** An old-fashioned favorite; its long racemes of graceful heart-shaped pink flowers are always attractive. 50c each.

DIGITALIS (Foxglove). The flower heads are over 3 ft. long, crowded with big, bell-shaped blossoms. Colors range from white and shell-pink to deepest rose.

DORONICUM excelsum (Leopard's Bane). Large, bright yellow daisy-like flowers. Early.

ECHINOPS ritro (Globe Thistle). Showy thistle-like plants with metallic-blue globular flowers. 3 ft. July to Sept.



Korean Chrysanthemum

EUPATORIUM COELESTINUM (Hardy Ageratum). Light purple flowers similar to Ageratum. Flowers from Aug. to frost.

FUNKIA (Plantain Lily). A beautiful class of plants growing well in partial shade.

- subcordata grandiflora (White Day Lily).** 2 ft. Pure white, trumpet-flowered, fragrant. July to September.
- undulata variegata.** 1 ft. Beautiful variegated foliage, flowers lilac.

GAILLARDIA grandiflora (Blanket Flower). 2 ft. Large crimson and gold; good for cutting. June to November.

- Goblin.** Deep red; dwarf.

GEUM Mrs. Bradshaw (Avens). Double flowers of bright red. Blooms all summer.

GYSOPHILA paniculata (Baby's Breath). 2 ft. An old-fashioned favorite; white flowers. June to August.

- Bodgeri.** Double white. All summer.
- Bristol Fairy.** Double. 50c each.
- Repens.** A creeping variety with tiny white flowers.
- Rosy Veil.** Double pink. All summer. 35c each.

HELENIUM autumnale rubrum. 5 ft. Reddish brown, aster-shaped flowers; profuse bloomer. August to October.

- autumnale superbum.** 5 ft. Immense heads of golden yellow flowers. August to October.

Riverton Gem, Old gold suffused with terra cotta. August to October.

HELLEBORUS niger (Christmas Rose). Pot grown plants. \$1.00 each.

HELIOPSIS pitcheriana (Ox-Eye). 3 ft. Very desirable, blooming all through the summer. Deep orange-yellow.

Hardy Perennial Plants

HEMEROCALLIS (Day Lily). Does well in partial shade and moist places.

flava. 3 ft. Golden yellow. May and June.

Sovereign. Chrome-yellow, shaded brown.

thunbergi. Very fragrant flowers; lemon-yellow, late.

HEUCHERA sanguinea. 1½ ft. Graceful spikes of delicate coral-red flowers. June and July.

HIBISCUS, Crimson Eye (Mallow). 4 ft. Large, pure white, with crimson spot in center. July and August.

moscheutos roseus. 4 ft. Pink. July and August.

moscheutos albus. 4 ft. White. July and August.

HOLLYHOCKS. Finest double variety. Separate colors or mixed.

Finest Single Varieties.

IBERIS sempervirens (Candytuft). 1 ft. Evergreen foliage; good for borders. May and June.

IRIS germanica (Garden Iris). They form a group unparalleled in beauty. Every shade of color may be found among them, and they will thrive in almost any soil or situation.

Alcazar. Tall deep purple.

Allure. Rose-pink.

Ambassadeur. Bronze standards, purple falls.

Asia. Silver standards, purple falls.

Bruno. Bronze standards, purple falls.

Buto. Deep blue-purple.

Coronation. Best yellow.

Cinnabar. Violet.

Duke of Bedford. Large deep purple.

Elizabeth Egelberg. Fine rose tone.

Euphony. Ruffled copper.

Freda Mohr. Pink bicolor.

Firefall. Bronze-red.

Lent A. Williamson. Soft lavender-violet; falls royal purple.

Lord of June. Large lavender-blue.

Midgard. Yellow and pink blend.

Seminole. Violet-rose and crimson.

Wedgewood. Blue.

IRIS, Japanese (*Iris Kaempferi*). 35c each, \$3.50 per doz. Double, except where noted.

Azurea. Blue.

Blue Danube. Blue with pure white veins, yellow center.

Gold Bound. White; yellow markings. Single.

Hercule. Clear lilac-blue. Single.

Mahogany. Mahogany-red.

Purple and Gold. Violet-purple.

Uchiu. Blue with golden center, and white. Single.

LAVANDULA vera. True lavender. 1 ft. Fragrant bluish flowers; foliage gray, with fragrance of lavender.

LIATRIS pycnostachya (Blazing Star). 4 ft. Showy spikes of rosy purple flowers. July to September.

LILY-OF-THE-VALLEY. Strong clumps. 50c each, \$5.00 per doz.

LINUM perenne. 18 in. Light blue flowers, which are produced all summer.

LOBELIA cardinalis (Cardinal Flower). 3 ft. Cardinal-red. August to October.

LYCHNIS chalconica (London Pride). 3 ft. Brilliant heads of crimson flowers. June to September.

viscaria. 1½ ft. Single, scarlet flowers, brilliant. July and August.

LYTHRUM roseum superbum. 3 ft. Spikes of deep rose-colored flowers. September.

MONARDA didyma (Oswego Tea). 3 ft. Aromatic foliage and bright scarlet flowers. June to September.

MYOSOTIS palustris (Forget-Me-Not). 10 in. Flowers all summer. Fine blue.

NEPETA mussini. Dwarf, covered with light blue flowers. Fine for rock garden. May to September.

OENOTHERA (Evening Primrose).

youngii. 18 in. Bright yellow. June to September.

PAPAVER orientale (Oriental Poppy). 3 ft. Brilliant scarlet with black center; very showy. June.

Mrs. Perry. Salmon-rose.

nudicaule (Iceland Poppy).

PENTSTEMON barbatus torreyi (Beard Tongue). 4 ft. Bright scarlet flowers. July to September.

digitalis. 3 ft. Pure white. July and August.

PEONIES (*Paeonia*). One of the hardiest flowering plants and rivalled only by the Rose.

Alsace-Lorraine. White, much like the white Pond Lily. Late. \$1.25 each.

Couronne d'Or. Pure white globular flowers, with amber-yellow stamens. Late. \$1.00 each.

Dorchester. Large and compact. Pale hydrangea-pink. Fragrant; late. \$1.00 each.

Dorothy Allison. Bright, fresh pink; dwarf habit. Mid-season. Single. \$2.00 each.

Duchesse de Nemours. Medium sized, pure white bloom. Strong, free bloomer; fragrant; early. 75c each.

Edulis superba. Rose-pink, very fragrant. Early. 75c each.

Eugenie Verdier. Flesh pink; extra fine variety, late. \$1.50 each.

Felix Crousse. Large, globular bloom. Brilliant red and a free bloomer. Fragrant; midseason. \$1.00 each.

Festiva Maxima. Very large; pure white center, petals tipped with bright crimson. Midseason, 75c each.

Georgiana Shaylor. Pale pink flecked with crimson; fine blooms late in the season. \$1.00 each.

Ginette. A flesh pink variety, very fragrant. Early. \$1.50 each.

James Kelway. A pure white variety, blooms early mid-season. \$1.50 each.



Mons. Jules Tils Peony

Hardy Perennial Plants

PEONIES—Continued.

- Lady Lillian Ogle.** Early single, pure white, fragrant. \$1.00 each.
- Le Cygne.** Pure milk white, incurved petals, midseason. \$2.00 each.
- Madame de Verneville.** Very large; pure white with center petals blush, tipped carmine. 75c each.
- Monsieur Jules Elie.** Large, compact. Pale lilac-rose with silvery reflex; fragrant, midseason. \$1.00 each.
- Norfolk.** Deep shell-pink with cup-shaped petals. Late. \$1.00 each.
- Venus.** Delicate shell-pink, compact bloom. \$1.50 each.
- Walter Faxon.** Large blooms; bright rose, deepening toward the center; fragrant; midseason. \$2.00 each.

PAEONIA officinalis, alba, rubra, rosea. \$1.00 each; \$10.00 per doz.

PEONIES, Mixed.

PHLOX paniculata (Hardy Perennial Phlox). A succession of flowers of greatest beauty, from early July until frost, in softest tones of pink and rose, salmon and white in great paniced blooms.

- B. Comte.** French purple.
- Caroline Vandenburg.** Violet-blue.
- Comus.** Cherry-red.
- Daily Sketch.** Salmon-pink.
- E. I. Farrington.** Salmon-pink.
- Enchantress.** Salmon-pink.
- Eugene Danzanvilliers.** Light lavender.
- Ethel Pritchard.** French mauve.
- Europa.** White, crimson eye.
- Firebrand.** Crimson-scarlet.
- Hauptmann Koehl.** Bright crimson.
- Jules Sandeau.** Dwarf pink.
- Leo Schlageter.** Brilliant scarlet.
- Lillian.** Pink.
- Mia Ruys.** Dwarf white.
- Miss Lingard.** Early white.
- Morgenrood.** Bright rose.
- Mrs. Jenkins.** White.
- Rheinlander.** Salmon-pink.
- Ruth May.** Flesh-pink.
- Salmon Glow.** Salmon-pink.
- Special French.** Clear pink.
- Thor.** Salmon-pink.
- Wm. Kesselring.** Purple, white eye.

PHLOX divaricata. 1 ft. Dwarf. Pale blue. Native variety. May and June.

subulata (Moss Pink). 4 to 6 in. Pink. April and May.

subulata alba. 4 to 6 in. White.

PHYSOSTEGIA virginica (False-dragonhead). One of the most attractive mid-summer plants, covered with clear pink, heath-like flowers. July and Aug.

Vivid. New dwarf variety with deep pink flowers.

PLATYCODON grandiflorum (Japanese Balloon Flower). 2½ ft. Large blue, Campanula-like flowers. July to Oct.

grandiflorum album. 2½ ft. White.

PLUMBAGO LARPENTAE (Leadwort). Dwarf and spreading. Covered with deep blue flowers during late summer.

PRIMULA (English Primrose). Bright canary-yellow. April and May.

denticulata. Neat, hardy species from Himalaya. Flowers early. Pale violet. 9-12 inches tall.

PYRETHRUM roseum (Persian Daisy). 2 ft. One of the showiest flowers. June to July. Single. Mixed.

uliginosum (Giant Daisy). 4 ft. Large white. Aug. and Sept.

RUBECKIA purpurea. 3 ft. Large, reddish purple, with dark, cone-shaped center of brown. July to Oct.

SALVIA Pitcheri. Slender spikes of pale blue flowers. Aug. to Sept. 3 ft.

SAPONARIA Ocyroides (Soap Wort). Attractive bright rose flowers, May to August. 8 in. A fine rock plant.

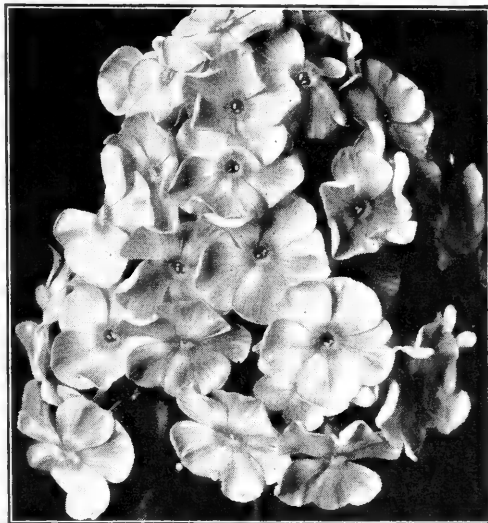

Phlox, Thor

SCABIOSA caucasica (Blue Bonnet). A soft and charming shade of lavender. June to September.

Fischeri. Deep blue. Well branched and free flowering. 4 feet. August to frost.

SEDUM numm. (Golden-moss). 4 in. Bright yellow, with green foliage. May to July.

album. 4 in. Green foliage, white flowers. July and Aug.

sexangulare. Dark green foliage. Yellow flower. 4 in.

Sieboldi. Showy pink flowers. September to October. 8 in.

spectabile (Showy Stonecrop). 18 in. An erect growing plant with broad green foliage and large heads of handsome rose-colored flowers.

spectabile, Brilliant. 1 ft. Sept. and Oct. A more richly colored form of *S. spectabile*. Bright amaranth-red.

SPIRAEA filipendula fl. pl. 2 ft. Double white. June and July.

STATICE latifolia (Sea Lavender). 1½ ft. Violet-blue. July to Sept.

STOKESIA cyanea (Cornflower Aster). 2 ft. Lavender-blue. A native plant; fine for cutting. July to Oct.

alba.

THYMUS lanuginosus (Woolly Thyme).

serpyllum (Creeping Thyme).

serpyllum album (White Mt. Thyme).

serpyllum coelebneum.

Plants are covered with crimson flowers.

TRITOMA uvaria grandiflora (Flameflower). 4 ft. Orange-scarlet. Aug. to Nov.

TROLLIUS europaeus (Globeflower). 1½ ft. Bright yellow. June to Sept. 35c.

ledebouri. Rich orange. 35c.

VERONICA (Speedwell).

incana. Silvery foliage, blue flowers. July and August. 1 ft.

longifolia subsessilis. One of the handsomest blue flowering plants. 1 ft. July to Sept.

VINCA minor (Myrtle). Creeping evergreen; good for covering ground in shady places. Bright blue flowers. April to July. \$15.00 per 100.

VIOLA, Jersey Gem. Rich violet color, fragrant; fine for borders or rockeries.

Plants on this page, 30c each, six of the same variety \$1.50, and twelve of the same variety \$2.50, except as noted.

Hybrid Tea (Everblooming) Roses

Two-year dormant plants, 75c each; \$8.00 per doz.
Pot-Grown plants, ready about May 15th. 85c each; \$9.50 per doz.

Ami Quinard. Extremely dark, velvety crimson-maroon.
Autumn. Gorgeous flowers of russet-brown, bronzy-red and rich yellow. Free bloomer.
Betty Uprichard. Semi-double, salmon-pink flowers stained with copper, pink on the outside.
Briarcliff. Silvery rose-pink.
Caledonia. The most desirable white. Long lasting.
Columbia. Extra large, glistening rose-pink, long stems.
Dame Edith Helen. Enormous, very double, pure pink blooms, continually produced.
Edith Nellie Perkins. Buds of rich orange, salmon-pink on interior, turning to golden shaded blooms.
Editor McFarland. Bright clear pink.
E. G. Hill. Dazzling scarlet shading to deeper red.
Etoile de Hollande. The world's leading red rose.
Gruss ■ Teplitz. Profuse, fragrant blooms of dark scarlet.
Joanna Hill. Light yellow, with bronze shadings in center.
Kaiserin Augusta Victoria. Cream shaded lemon.
Mrs. Henry Morse. Light pink.
McGredy's Scarlet. A beautifully formed, double, high-centered variety of brilliant red, borne on long stems.

Margaret McGredy. Oriental-red.
Mev. G. A. Van Rossem. Buds yellow, veins orange-brown, full, double, fragrant flowers open lighter.
Miss Rowena Thom. Very large, brilliant rose-pink.
Mme. Edouard Herriot. Coral or brick-red.
Mrs. Aaron Ward. Color Indian yellow, shading to lemon.
Mrs. Chas. Bell. Shell pink.
Mrs. E. P. Thom. One of the best yellows.
Mrs. Pierre S. Du Pont. Reddish gold buds turn to lasting and fragrant blooms of deep golden-yellow.
Mme. Butterfly. Similar to Ophelia but larger flower.
President Herbert Hoover. An outstanding novelty of maroon, orange and gold; a perfect rose for the home garden.
Radiance. Soft carmine-pink. Double; sweet-scented.
Red Radiance. A crimson sport of Radiance.
Sister Therese. Golden yellow.
Souvenir de Claudius Pernet. The best and one of the few really yellow, with ■ pointed bud and glossy foliage.
Talisman. Most vividly colored rose, apricot shading to yellow at base, strong grower, free bloomer.
White Killarney. A pure white rose.

New Patented Roses

Pot-grown plants only. Ready for delivery about May 15th.
Countess Vandal. Plant patent No. 88. A lovely coppery pink and gold, extra long pointed buds. \$1.00 each.
Crimson Glory. Plant Patent No. 105. Large, urn-shaped buds which open to flowers of an intense deep and vivid crimson shaded with deep red. \$1.25 each.
R. M. S. Queen Mary. Plant Patent No. 249. Salmon-pink. \$1.25 each.

Climbing Roses

Two-year dormant plants, 60c each, \$6.00 per doz., except where noted.

American Pillar. Chaste pink, white center; single.
Blaze (U. S. Plant Patent No. 10). Everblooming Paul's Scarlet Climber. A vigorous climber producing flowers of the blazing color of Paul's Scarlet and the everblooming habit of Gruss an Teplitz. \$1.00 each.
Climbing American Beauty. Rose-pink; fragrant.
Crimson Rambler. Large clusters of crimson flowers. 50c.
Dr. W. Van Fleet. Flesh pink. Double and fragrant.
Dorothy Perkins. Soft shell-pink. 50c.
Doubleblooms (Plant Patent No. 152). A vigorous climber with heavy wood and handsome glossy foliage. Buds ovoid, deep saffron yellow, flowers large, double, cupped; rich gold, fragrant. Gives two liberal crops six weeks apart if the first spring blooms have not been cut. \$1.50 each.
Excelsa. Intense crimson maroon. Healthy foliage; fine.
Golden Climber (Mrs. Arthur Curtis James). Plant patent No. 28. A full semi-double yellow rose averaging four to five inches in diameter. Blooms of hybrid tea type, on stems often eighteen inches or longer. \$1.00 each.
Jacotte. Flower large, semi-double, coppery yellow, tinted coppery red.
Mary Wallace. Semi-double, rose-pink, with salmon base.
Max Graf. Trailing Hybrid Rugosa Rose. Valuable as a ground cover. Foliage of the Rugosa type. Flowers single and bright pink. 60c each, \$6.00 per doz.
Paul's Scarlet Climber. Vivid scarlet, semi-double flowers of medium size, produced in large clusters.
Silver Moon. Silvery white. Foliage is mildew proof.
The New Dawn. The everblooming Dr. W. Van Fleet. \$1.50.
White Dorothy Perkins.

Hybrid Perpetual Roses

Two-year dormant plants, 75c each; \$8.00 per doz.
Frau Karl Druschki. Pure white; large and free flowering.
General Jacqueminot. Brilliant crimson; fragrant.
George Arends. The pink Druschki. Soft pink.
J. B. Clark. Red.
Magna Charta. A bright, clear pink.
Mrs. John Laing. A constant blooming rose. Shell-pink.
Paul Neyron. A deep rose color; large.
Prince Camille de Rohan. Deep maroon-red.
Ulrich Brunner. Bright cherry-red; fragrant.

Baby Rambler Roses

Two-year, dormant plants, 75c each; \$8.00 per doz.
Else Poulsen. Semi-double, rose-pink.
Gloria Mundi. Very double flowers of rich orange-scarlet.
Golden Salmon. Orange.
Gruss an Aachen. Salmon-pink.
Triomphe Orleansais. A very fine crimson.
Ideal. Rich garnet-red.
Miss Edith Cavell. Semi-double. Scarlet-red, with darker shadings.

Miscellaneous Hardy Roses

Rosa rugosa rubra. Red. 60c each, \$6.00 per doz.
Rosa rugosa alba. White. 75c each, \$7.50 per doz.
F. J. Grootendorst. A strong, shrubby grower. The flowers are produced in large clusters like the Crimson Baby Rambler. 2-year plants, 60c each, \$6.00 per doz.
Rosa Hugonis (Golden Rose of China). Early. 60c each.
Rosa Wichuraiana (Memorial Rose). Single, white. 50c each.

Tri-O-Gen Rose Garden Spray

Combined spray treatment, fungicide, insecticide, and plant stimulant. Combined ■ a Kit. Harmless to foliage or blooms. Small Kit \$1.50; Medium Kit, \$4.00; Large Kit, (makes 32 gallons), \$6.00.

Deciduous Shrubs

Ornamental shrubs occupy an important place in the home garden. They present variety of color, season of bloom and type of growth, as well as producing brilliant colored foliage in the fall and bright-colored berries in the winter.

ALMOND (*Amygdalus*). Produces double, rose-colored flowers in great profusion in early spring. ■ to ■ ft., 75c each; 3 to 4 ft., \$1.00 each.

ALTHEA (*Hibiscus syriacus*). Rose-of-Sharon. Tall growing, late flowering shrubs of unusual beauty. Pink, purple, red and white. Bush form. 2 to 3 ft., 50c each; 3 to 4 ft., 60c each; tree form, 75c each.

ARALIA (*Acanthopanax pentaphylla*). A graceful shrub with spiny branches and bright green foliage. 2 to 3 ft., 50c each; 3 to 4 ft., 75c each.

AZALEA arborescens (*Sweet Azalea*). Fragrant white flowers in June. 1 to 1½ ft., \$1.50; 1½ to 2 ft., \$2.00 each. **kaempferi** (*Torch Azalea*). Orange-red. 18 to 24 in., \$2.50 each.

calendulacea (*Flame Azalea*). Flame-red flowers late in May. 1½ to 2 ft., \$2.00 each; 2 to 2½ ft., \$2.50 each.

mollis (*Chinese Azalea*). Mixed colors. 12 to 18 in., \$2.00; 18 to 24 in., \$2.50 each.

nudiflora (*Pinksterflower*). Deep pink to reddish purple. 1 to 1½ ft., \$1.75 each; 1½ to 2 ft., \$2.25 each.

poukhanensis (*Korean Azalea*). Low growing; pale lilac-purple. 18 to 24 in., \$2.50 each.

viscosa (*Swamp Azalea*). Fragrant white flowers in July; prefers damp soil. 2 to 2½ ft., \$2.00 each.

BARBERRY, Japanese. See Hedge Plants, page 80. **Redleaf Japanese** (*Berberis thunbergii atropurpurea*). 18 to 24 in., 50c each.

BERBERIS THUNBERGI PLURIFLORA ERECTA (U. S. Plant Patent No. 110). (True Hedge Column-berry). This new barberry is pyramidal in habit, with foliage of a dense deep shade of green. It is easily trained into perfect spires and pyramids and makes a beautiful hedge, requiring very little trimming.

	Each	10	100
12-15 in.	\$0.30	\$2.50	\$17.00
15-18 in.35	2.80	20.00
18-24 in.45	3.30	25.00
24-30 in.55	4.50	35.00
30-36 in.75	6.00	50.00

BUDDLEIA, Butterfly Bush.
Alternifolia. Lavender-purple. 50c each.
Davidi magnifica. Purple with orange eye. 50c each.
He de France. Purple with golden eye. 50c each.

CORALBERRY (*Symphoricarpos vulgaris*). Clusters of coral-red berries last throughout the winter. ■ to ■ ft., 50c each; 3 to 4 ft., 60c each.

COTONEASTER divaricata (*Spreading Cotoneaster*). A spreading variety with arching branches. Pink flowers are produced in June and bright red fruit in September. 2 to 3 ft., \$1.00 each; \$10.00 per doz.

horizontalis (*Rock Cotoneaster*). A low shrub with horizontal branches and small glossy green leaves. The flowers are pinkish white and the fruit is bright red. A desirable variety for planting in the rock garden. 5-in. pots, 6 to 9 in., 60c each; 7-in. pots, 15 to 18 in., \$1.00 each.

DAPHNE mezereum (*February Daphne*). A small hardy shrub blooming long before the leaves appear. The stems are closely set with deep red, fragrant flowers. 15 to 18 in., 75c each; 18 to 24 in., \$1.00 each.

DEUTZIA gracilis. Dwarf; white flowers cover the entire plant in May. 1 to 1½ ft., 50c each.

lemonel. Medium growth. White flowers on erect stems in June. 2 to 2½ ft., 50c each.

Pride of Rochester. Tall; double white flower tinged with pink; in late June. 2 to 3 ft., 50c each; 3 to 4 ft., 60c each.

DOGWOOD (*Cornus*). Strong growing shrubs, attractive for their bloom, berries, leaf coloring, and colored bark.
Cornus alba. Flowers white, fruit blue, branches red. 3 to 4 ft., 60c; 4 to 5 ft., 75c.
Cornus mascula (*Cornelian Cherry*). 3 to 4 ft., \$1.25.
Cornus stolonifera flaviramea. Flowers white, branches yellow. 2 to 3 ft., 50c each.

EUONYMUS alatus (*Winged Burningbush*). A handsome shrub of medium growth. Peculiar winged branches; foliage light green changing to bright crimson in autumn. 3 to 4 ft., \$1.00 each.

a. compacta (*Dwarf Winged Euonymus*). A choice dwarf, compact shrub which is unquestionably one of the best deciduous shrubs for growing in the shade. For a low-wide hedge this variety has no equal. 1½-2 ft., 75c each; \$7.50 per doz.; \$60.00 per 100. 2-2½ ft., \$1.00 each; \$10.00 per doz.; \$75.00 per 100. 2½-3 ft., \$1.35 each; \$12.75 per doz.

FORSYTHIA (*Golden Bell*). First of the spring flowering shrubs. Rich green foliage; tall and graceful in habit.

fortunei. Upright growth. 3 to 4 ft., 50c each; 4 to 5 ft., 75c each.

intermedia. Medium growth. 2 to 3 ft., 50c each; 3 to 4 ft., 60c each.

suspensa. Weeping habit. 2 to 3 ft., 50c each; 3 to 4 ft., 75c each.

FRINGE TREE (*Chionanthus virginica*). A large growing shrub with heavy foliage and lacy white flowers. 3 to 4 ft., \$1.50 each.

HONEYSUCKLE (*Lonicera*). Tall, bushy, hardy shrubs.
Morrow Honeysuckle. (*L. morrowi*). Medium height, drooping branches, white flowers, red fruit. 2 to 3 ft., 50c each; 3 to 4 ft., 75c each.

Tatarian Honeysuckle (*L. tatarica*). Tall, pink flowers, crimson fruit. 2 to 3 ft., 50c each; 3 to 4 ft., 75c each.

White Tatarian Honeysuckle (*L. tatarica alba*). Tall, white flowers, crimson fruit. 3 to 4 ft., 75c each.

HYDRANGEA arborescens grandiflora (*Hills of Snow*). Large clusters of white flowers in midsummer. 18 to 24 in., 50c each; 2 to 3 ft., 75c each.

paniculata grandiflora. The old-fashioned, common variety with large heads of white flowers in late summer which turn a bright pink in fall. 2 to 3 ft., 50c each; 3 to 4 ft., 75c each.

Standard or Tree Hydrangea. 4 to 5 ft., \$1.50 each.

JETBEAD (*Rhodotypos kerriodes*). Medium height; single, white flowers followed by shiny, black fruit which last throughout the winter. 2 to 3 ft., 50c each; 3 to 4 ft., 75c each.

KOLKWITZIA amabilis (*Beautybush*). A free-growing shrub with tubular pink flowers produced abundantly in rounded clusters the whole length of the branches. 2 to 3 ft., 75c each; 3 to 4 ft., \$1.00 each.

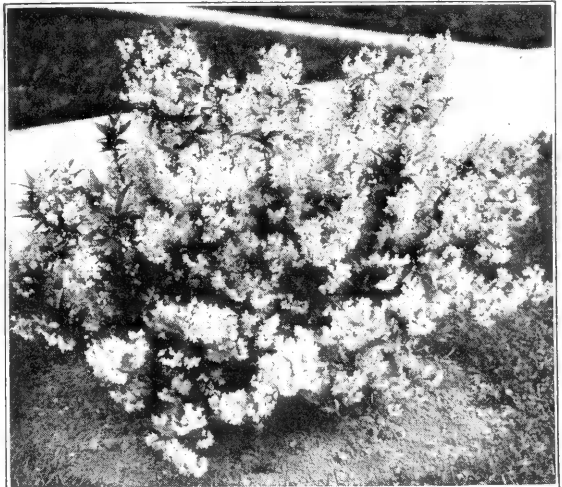

Deutzia Gracilis

Deciduous Shrubs—Continued

LILAC (*Syringa*). Old-fashioned favorites familiar to all.
Common Purple. 2 to 3 ft., 50c each; 3 to 4 ft., 75c each.
Common White. 1½ to 2 ft., 50c each; 2 to 3 ft., 60c each; 3 to 4 ft., 75c each.

Persian Lilac. Very fragrant, pale purple flowers in loose panicles. 2 to 3 ft., 50c each.

Villosa Lilac. Heavy bright green foliage, flowers rosy white and fragrant; late blooming. 3 to 4 ft., 60c each; 4 to 5 ft., 75c each.

HYBRID LILACS. Unlike the old varieties, this type bloom when very young and their double and single blooms are produced in a wide range of color. The varieties listed are priced as follows: 1½ to 2 ft., 65c each; 2 to 3 ft., 75c each; 3 to 4 ft., \$1.00 each.

Single Varieties:

Amelia Dupret. Pale lilac.

Chas. X. Reddish purple.

Congo. Dark crimson.

Marie Legeray. White.

Rubra de Marly. Purple.

Souv. de Ludwig Spaeth. Red.

Double Varieties:

Alphonse Lavallee. Light blue.

Belle de Nancy. Satin pink.

Doyenne Keteleer. Light pink.

Michel Buchner. Lilac-purple.

Mme. Lemoine. White.

Ville de Troyes. Dark purple.

PEPPERBUSH (*Clethra alnifolia*). Medium growth, white fragrant flowers in midsummer. 18 to 24 in. 50c each.

PRIVET (*Ligustrum*). Hedge varieties, see page 80.
Regel Privet (*L. regelianum*). Low-spreading shrub of graceful habit. A fine border shrub. 1½ to 2 ft., 50c each, \$5.00 per doz.

JAPANESE QUINCE (*Cydonia japonica*). Dark green, glossy foliage; scarlet flowers in May. 1½ to 2 ft., 50c each; 2 to 3 ft., 75c each.

FLOWERING RASPBERRY (*Rubus odoratus*).

A shade-growing plant of medium height; flowers rosy purple, 50c each.

SIBERIAN PEA-TREE (*Caragana arborescens*). A hardy, tall growing shrub with dark green wood, light green foliage and small, pea-shaped flowers in June. 2 to 3 ft., 50c each; 3 to 4 ft., 75c each.

SMOKE BUSH (*Rhus cotinus*). Much admired for its clusters of purplish, misty flowers in June. 2 to 3 ft., 75c each; 3 to 4 ft., \$1.00 each.

SPIREA (*Spiraea*). An interesting family of flowering shrubs, covering a wide range of bloom. Very hardy.

Anthony Waterer. Dwarf; rose-pink blooms in July and August. 1½ to 2 ft., 50c each.

bumalda. A light pink variety of the above. 18 to 24 in., 50c each.

froebeli. A stronger grower than Anthony Waterer; rose-pink blooms in July and Aug. 1½ to 2 ft., 50c each; 2 to 3 ft., 60c each.

prunifolia. The true Bridalwreath. Tiny white flowers in great masses along the stems are produced late in May. 2 to 3 ft., 50c each; 3 to 4 ft., 75c each.

thunbergi. Medium growth; small white flowers in early May; graceful habit. 2 to 3 ft. 50c each.

trichocarpa (Korean Spirea). A newer variety much like *S. vanhouttei*, but blooming about two weeks later. 2 to 3 ft., 50c each; 3 to 4 ft., 75c each.

Vanhouttei. The finest of all Spireas. Graceful arching branches are completely covered with white flowers in June. 2 to 3 ft., 50c each; 3 to 4 ft., 60c each; 4 to 5 ft., 75c each.

STEPHANANDRA flexuosa. Spreading and drooping in habit; foliage finely cut and lacy; flowers white. 2 to 3 ft., 50c each.

SNOWBERRY (*Symphoricarpos racemosus*). A bushy shrub with slender branches which droop gracefully; white waxy berries cover the plant in fall. 2 to 3 ft., 50c each; 3 to 4 ft., 75c each.

SYRINGA.

Common Syringa (*Philadelphus coronarius*). Tall, pure white, fragrant flowers in June. 3 to 4 ft., 50c each; 4 to 5 ft., 75c each.

Golden Syringa (*Philadelphus coronarius aurea*). A dwarf variety with bright yellow foliage. 1 to 1½ ft., 50c each; 1½ to 2 ft., 60c each.

Large-Flowered Syringa (*Philadelphus grandiflorus*). A vigorous growing variety; white flowers. 3 to 4 ft., 50c each; 4 to 5 ft., 75c each.

Virginal. Very large semi-double, white flowers, blooming throughout the summer. 2 to 3 ft., 60c each; 3 to 4 ft., 75c each.

VIBURNUM.

Dwarf Viburnum (*V. opulus nana*). A dense, compact, dwarf plant useful for very low borders. 10 in., 50c each; \$5.00 per doz.

European High Bush Cranberry (*V. opulus*). A tall growing shrub producing large clusters of scarlet fruit late in the summer. 2 to 3 ft., 50c each; 3 to 4 ft., 75c each.

Common Snowball (*V. opulus sterile*). An old favorite. 2 to 3 ft., 50c each; 3 to 4 ft., 75c each.

Japan Snowball (*V. plicatum*). A compact grower with heavy foliage. Round white flowers in May. 2 to 3 ft., 75c each.

Single Japan Snowball (*V. tomentosum*). 1½ to 2 ft., 50c each. 2 to 3 ft., 75c each.

May-flowering Viburnum (*V. carlesii*). Compact and bushy in growth; fragrant, pink flowers in May. A choice variety. 12 to 18 in., \$1.50 each; 18 to 24 in., \$1.75 each; 2 to 2½ ft., \$2.00 each.

WEIGELA. These valuable shrubs produce trumpet-shaped flowers in great profusion during May and June.
candida. White. 2 to 3 ft., 50c each.

Eva Rathke. Dark reddish green foliage; dark red blossoms throughout summer. 2 to 3 ft., 50c each.

rosea. A tall growing variety, producing pink flowers in June. 2 to 3 ft., 50c each; 3 to 4 ft., 75c each.

Variiegated. A dwarfish type with white margined leaves; flowers white. 1½ to 2 ft., 50c each; 2 to 3 ft., 75c each.

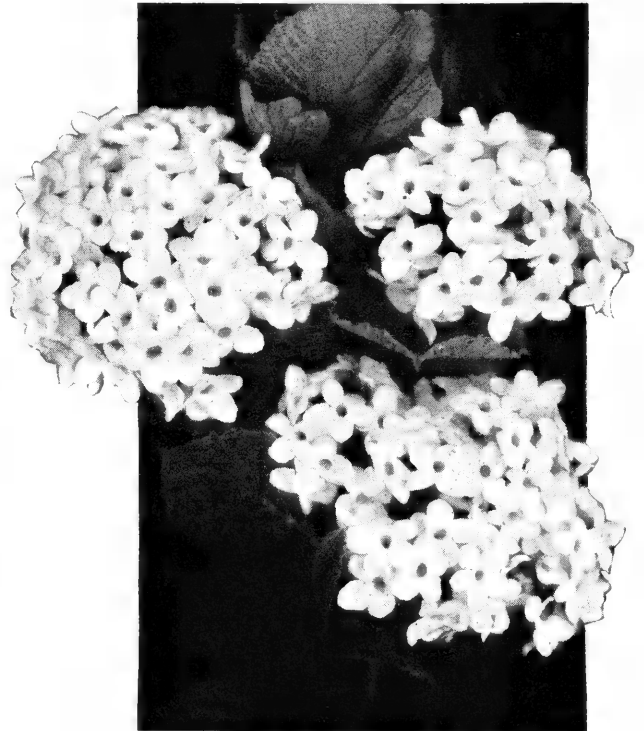

Viburnum Carlesii (May-Flowering Viburnum)

Deciduous Trees

Ash - Fraxinus

American White (*F. americana*). A large, broad-headed tree suitable for lawn or street planting. 10 to 12 ft., \$2.00 each; 12 to 14 ft., \$2.50 each.

Beech - Fagus

European Beech (*F. sylvatica*). Light green foliage; compact in habit. 11 to 3 ft., \$1.50 each; 3 to 4 ft., \$2.00 each; 4 to 5 ft., \$3.00 each.

Purple Beech (*F. sylvatica purpurea*). Rich purplish foliage. A desirable lawn tree. 2 to 3 ft., \$4.00 each; 3 to 4 ft., \$6.00 each.

Birch - Betula

European White Birch (*B. alba*). 5-6 ft., \$1.25 each.

Cutleaved Weeping Birch (*B. alba laciniata*). 11 to 6 ft., \$2.50 each; 6 to 8 ft., \$3.00 each; 8 to 10 ft., \$3.50 each.

Canoe Birch (*B. papyrifera*). 6 to 8 ft., \$2.50 each.

Catalpa

Umbrella Catalpa (*C. bungei*). Dense, globe-shaped heads on slender stems. 1 yr. heads, \$1.50; 2-yr. heads, \$2.00.

Flowering Crab - Malus

The Flowering Crabs are slow growing trees with fragrant blossoms from pure white to deep red. Ideal trees for garden border or single specimens.

The following varieties: 3 to 4 ft., \$1.50 each; 4 to 5 ft., \$1.75 each; 5 to 6 ft., \$2.50 each.

Bechtels Crab (*M. ioensis plena*). Double pink in clusters.

Carmine Crab (*M. atrosanguinea*). Brilliant carmine.

Japanese Crab (*M. floribunda*). Pinkish buds, white flowers.

Parkman Crab (*M. halliana parkmani*). Double rose-red.

Redvein Crab (*M. niedzwetzkyana*). Early flowering red.

Dogwood - Cornus

Redflower Dogwood (*C. florida rubra*). 3 to 4 ft., \$2.50 each; 4 to 5 ft., \$4.00 each; 5 to 6 ft., \$5.75 each; 6 to 7 ft., \$7.00 each.

Whiteflowering Dogwood (*C. florida*). 3 to 4 ft., \$1.50 each; 4 to 5 ft., \$2.00 each; 5 to 6 ft., \$3.00 each; 6 to 11 ft., \$4.50 each; 8 to 10 ft., \$6.00 each.

Elm - Ulmus

American Elm (*U. americana*). 11 to 10 ft., \$1.25 each; 10 to 12 ft., \$1.50 each; 12 to 14 ft., \$2.00 each.

Chinese Elm (*U. pumila*). 5 to 11 ft., \$1.50 each; 11 to 12 ft., \$2.00 each; 12 to 10 ft., \$2.25 each; 10 to 12 ft., \$2.50 each.

Moline Elm (*U. americana moline*). A large, fast growing tree with handsome foliage. 11 to 10 ft., \$1.50 each; 10 to 12 ft., \$2.00 each; 12 to 14 ft., \$2.75 each.

Hawthorn - Crataegus

Scarlet Hawthorn (*C. oxyacantha pauli*). 3 to 4 ft., \$1.75 each; 4 to 5 ft., \$2.25 each; 5 to 6 ft., \$3.00 each.

White Hawthorn (*C. oxyacantha alba*). 3 to 4 ft., \$1.75 each; 4 to 5 ft., \$2.25 each; 5 to 6 ft., \$3.00 each.

Judas-Tree - Cercis

Redbud ■ Judas-tree (*C. canadensis*). 4 to 5 ft., \$1.50 each; 5 to 6 ft., \$2.00 each.

Linden - Tilia

American Linden (*T. platyphyllos*). 8 to 10 ft., \$2.00 each.

European Linden (*T. vulgaris*). 6 to 8 ft., \$2.50; 8 to 10 ft., \$3.50.

Maidenhair-Tree - Ginkgo

Maidenhair-tree (*G. biloba*). Fan-shaped foliage, resembling the Maidenhair Fern. Very ornamental. 6 to 8 ft., \$3.50 each; 11 to 10 ft., \$4.50.

Magnolia

Soulangiana (*Saucer Magnolia*). 2 to 3 ft., \$2.50 each; 11 to 4 ft., \$4.50 each; 4 to 5 ft., \$5.50 each.

Stellata. 18 to 24 in., \$3.50 each; 11 to 2 1/2 ft., \$4.50 each.

Maple - Acer

Norway Maple (*A. platanoides*). 11 to 10 ft., \$1.75 each; 10 to 12 ft., \$2.50 each; 12 to 14 ft., \$3.50 each; 14 to 16 ft., \$4.50 each.

Rock Maple (*A. saccharum*) ■ to 10 ft., \$1.75 each; 10 to 12 ft., \$2.75 each; 12 to 14 ft., \$3.50 each.

Schwedleri Maple (*A. schwedleri*). Purplish foliage. A very desirable lawn tree. 6 to 8 ft., \$2.00 each; 11 to 10 ft., \$2.75 each; 10 to 12 ft., \$4.00 each.

Silver Maple (*A. dasycarpum*). A rapid growing tree for lawn or street planting. 8 to 10 ft., \$1.50 each; 10 to 12 ft., \$2.00 each.

Wier's Cutleaved Weeping Maple (*A. dasycarpum wieri*). A graceful, drooping tree of rapid growth; ideal ■ ■ ■ lawn specimen. 6 to 8 ft., \$1.50 each; 8 to 10 ft., \$1.75 each; 10 to 12 ft., \$2.00 each; 12 to 14 ft., \$3.00 each.

Bloodleaved Japan Maple (*A. palmatum atropurpureum*). Very dwarf; deep blood red foliage. 15 to 18 in., \$1.75 each; 18 to 24 in., \$2.25 each; 2 to 2 1/2 ft., \$3.50 each.

Mountain-Ash (Sorbus)

European Mountain-Ash (*S. aucuparia*). White flowers in May; clusters of orange-red berries in autumn; medium growth. 11 to 8 ft., \$2.00 each; 8 to 10 ft., \$2.75 each; 10 to 12 ft., \$3.50 each.

Mulberry (Morus)

Teas' Weeping Mulberry (*M. tatarica pendula*). A dwarf weeping tree with long, pendulous branches which droop to the ground. \$2.50 each.

Oak - Quercus

Pin Oak (*Q. palustris*). Pyramidal habit, deeply cut leaves. 11 to 8 ft., \$2.00 each; 8 to 10 ft., \$2.50 each; 10 to 12 ft., \$3.50 each.

Red Oak (*Q. rubra*). 11 to 11 ft., \$3.00 each.

Poplar - Populus Carolina Poplar (P. deltoides)

Tall and spreading, rapid growth. 6 to 11 ft., 75c each; 11 to 10 ft., \$1.00 each; 10 to 12 ft., \$1.50 each.

Lombardy Poplar (*P. nigra italica*). A tree of rapid growth, useful for screening. The trees which we offer are bushy and the branches start from the ground. 11 to 11 ft., \$1.00 each, \$11.00 per doz.; 8 to 10 ft., \$1.25 each, \$13.00 per doz.; 10 to 12 ft., \$1.75 each, \$18.00 per doz.

Willow - Salix

Golden Bark Willow (*S. vitellina aurea*). 6 to 8 ft., \$1.25 each.

Laurel-leaved Willow (*S. pentandra*). 4 to 5 ft., 75c each; 5 to 11 ft., \$1.00 each; 11 to 11 ft., \$1.25 each.

Thurlow's Willow (*S. elegantissima*). 11 to 11 ft., \$1.50 each; 8 to 10 ft., \$2.00 each; 10 to 12 ft., \$2.75 each.

Wisconsin Weeping Willow (*S. blanda*). 6 to 8 ft., \$1.50 each; 8 to 10 ft., \$2.00 each.

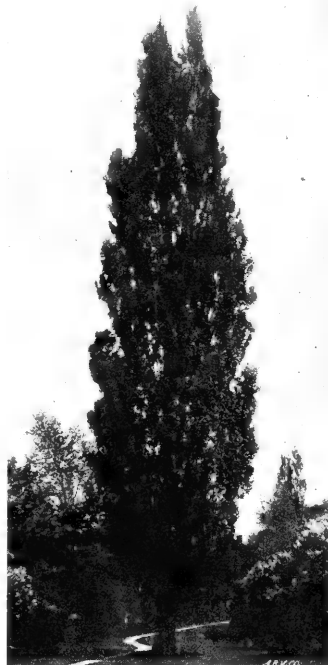

Lombardy Poplar

Hardy Climbing Plants and Flowering Vines

	Each	Doz.
ACTINIDIA arguta. Oval, glossy leaves and clusters of fragrant flowers	\$0.60	\$6.75
AKEBIA quinata. Clover-like leaves and fragrant, velvety purple flowers75	7.50
AMPELOPSIS quinquefolia (Virginia Creeper). Rapid grower50	5.00
engelmanni. A creeper that clings to stone or wood as tightly as English Ivy50	5.00
veitchi (Japanese or Boston Ivy). Very fine for covering walls, rocks, etc.50	5.50
Pot-grown, ready May 15th75	8.50
ARISTOLOCHIA siphon (Dutchman's Pipe). Heart-shaped leaves; the brown flowers resemble a pipe	1.00	10.00
BIGNONIA radicans (Trumpet Flower). Large trumpet-shaped, orange and red flowers. .	.50	5.50
CELASTRUS orbiculatus (Japanese Bittersweet). A strong climbing shrub with glossy green foliage, and in autumn covered with bright yellow fruit50	5.00
scandens (Roxbury Waxwork). Glossy leaves and clusters of orange-crimson fruit, which remains on all winter50	5.00
CLEMATIS paniculata. Glossy, dark green foliage, and covered in the latter part of the summer with starlike white flowers, fragrant35	3.75
Extra large50	5.50
Pot-grown, ready May 15th75	8.25
henryi. One of the best whites; very large white flowers often as much as 4 inches across. A continuous bloomer	1.00	10.00
Jackmani. Large violet-purple; free bloomer. .	1.00	10.00
Mme. Edouard Andre. Large carmine-red flowers; very free bloomer	1.00	10.00
ENGLISH IVY (Hedera helix). A very desirable evergreen climber, succeeds best in sheltered, shady situation50	5.00
HYDRANGEA petiolaris.		
12 to 15 in.	1.00	
2½ to 3 ft.	2.00	
LONICERA (Honeysuckle). Old favorites, shrubby climbers, fine for porches and trellises. Very fragrant.		
Hall's Japan. Fragrant, yellow and cream colored flowers all summer40	4.50
Pot-grown, ready May 15th75	8.25
Heckrottii. Golden Flame Honeysuckle. Ever-blooming and fragrant. Flowers red inside and yellow outside60	
Scarlet Trumpet. Clusters of tubular scarlet flowers all summer50	5.50



Hall's Japan Honeysuckle

	Each	Doz.
LYCIUM chinense (Matrimony Vine). A climbing shrub with light green foliage and pale purple flowers; fine for northern exposures	\$0.50	\$5.00
POLYGONUM auberti (Silver Lace Vine). A very strong growing, decorative climbing plant, staying in bloom through the summer and autumn. The flowers are in large sprays of pure white75	7.50
WISTERIA sinensis (Chinese Wisteria). Long, pendulous clusters of pale blue75	7.50
sinensis alba. White-flowered	1.00	10.00

Hedge Plants

BARBERRY thunbergii or Japanese.		
	Doz.	100
15 to 18 in.	\$2.00	\$15.00
18 to 24 in.	2.50	18.00
24 to 30 in.	3.50	25.00
PRIVET, Amur River.		
18 to 24 in.	1.50	10.00
24 to 36 in.	1.75	12.00
36 to 48 in.	2.50	20.00
California.		
18 to 24 in.90	6.00
24 to 36 in.	1.25	7.50
36 to 48 in.	1.75	12.00
Ibota.		
18 to 24 in.	1.75	12.00
24 to 36 in.	2.50	18.00

		Doz.	100
PRIVET, ibolium. A cross between Ibota and California Privet. It has the attractive dark green leaves of the California, but it is of a more branching habit, making a more compact hedge in less time. The best of all Privets.			
18 to 24 in.	\$1.50	\$ 7.50	
24 to 36 in.	2.00	10.00	
36 to 48 in.	2.50	15.00	
LILAC, Common.			
Purple. 2 to 3 ft.	5.00	30.00	
White 18 to 24 in.	5.00	38.00	
White. 2 to 3 ft.	6.50	50.00	
SPIREA vanhouttei.			
2 to 3 ft.	4.00	25.00	
HEMLOCK.			
1½ to 2 ft.	22.00		
SPRUCE, Norway.			
2 to 3 ft.	16.00		

Evergreen Trees

Arborvitae - Thuja

American Arborvitae (*T. occidentalis*). The common upright variety used in single specimens and for hedges. 3 to 4 ft., \$2.00 each; 4 to 5 ft., \$2.50 each; 5 to 6 ft., \$3.00 each; 6 to 7 ft., \$4.00 each; 7 to 8 ft., \$5.00 each; 8 to 9 ft., \$6.50 each; 9 to 10 ft., \$10.00 each.

Dark American Arborvitae (*T. occidentalis nigra*). A newer variety with foliage much darker than the American and hardier. 2 to 3 ft., \$1.75 each; 3 to 4 ft., \$2.00 each.

George Peabody Arborvitae (*T. occidentalis lutea*). Similar to the American in habit; foliage golden yellow. 3 to 4 ft., \$2.50 each; 4 to 5 ft., \$3.00 each.

Globe Arborvitae (*T. occidentalis globosa*). Round, compact form with dense foliage; dwarf. 12 to 15 in., 75c each; 15 to 18 in., \$1.25 each; 18 to 24 in., \$1.75 each.

Little Gem Arborvitae (*T. occ. Little Gem*). One of the few Arbor-Vitae which is a true dwarf. The foliage is dark green. An ideal dwarf evergreen for the rock garden. 6 to 8 in., \$1.00 each; 8 to 10 in., \$1.25 each.

Pyramidal Arborvitae (*T. occidentalis pyramidalis*). A most valuable upright evergreen of dense, compact habit. Foliage dark green. 2 to 3 ft., \$1.75 each; 3 to 4 ft., \$2.50 each.

Rosenthal Arborvitae (*T. occidentalis Rosenthal*). One of the best of the pyramid type. It makes a compact, broad, symmetrical pyramid and is very useful for formal plantings and specimens. The foliage, which is lustrous, dark green, retains its color throughout the entire winter. 3 to 4 ft., \$3.00 each; 4 to 5 ft., \$3.75 each; 5 to 6 ft., \$4.50 each.

Siberian Arborvitae (*T. occidentalis sibirica*). A very hardy variety holding its dark green color throughout the entire year; low and bushy in habit. 2 to 2½ ft., \$2.00 each; 2½ to 3 ft., \$2.50 each.

Vervaeke Arborvitae (*T. occidentalis vervaekiana*). The foliage shows a little golden tinge; densely branched and of columnar habit. 5 to 6 ft., \$4.00 each; 6 to 7 ft., \$5.00 each.

Fir - Abies

Fraser Fir (*A. fraseri*). A compact pyramidal grower. The foliage, which is fragrant, is a lustrous, dark green and is bluish-white beneath. Resembles closely the Balsam Fir. 2 to 3 ft., \$1.50 each; 3 to 4 ft., \$2.50 each; 4 to 5 ft., \$3.00 each; 6 to 7 ft., \$4.50 each.

Nikko Fir (*A. homolepis* (*Brachyphylla*)). This is a tall growing tree from the mountains of central Japan. The dark green leaves are silvery white beneath. A handsome lawn tree. 2½ to 3 ft., \$1.50 each; 3 to 4 ft., \$2.50 each; 4 to 5 ft., \$3.00 each; 5 to 6 ft., \$4.00 each.



Pfitzer Juniper

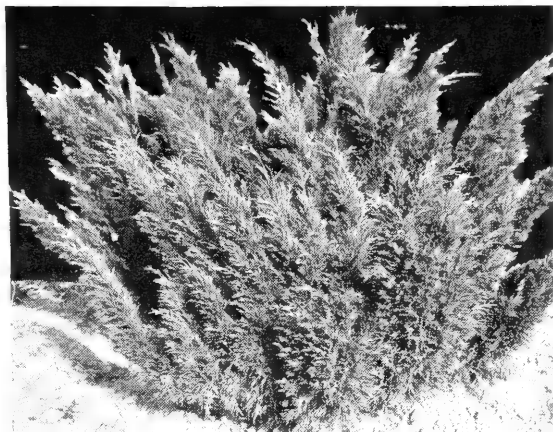

Savin Juniper

Veitch Fir (*A. veitchii*). The most rapid growing of all the Firs. Symmetrical in shape with dark green foliage, silvered on the under side. 2½ to 3 ft., \$2.50 each; 3 to 4 ft., \$2.75 each; 4 to 5 ft., \$3.50 each; 5 to 6 ft., \$4.50 each.

White Fir (*A. concolor*). A rapid growing tree of majestic proportions when mature. The color varies from light green to almost blue. One of our finest specimen lawn trees. 2 to 3 ft., \$2.25 each; 3 to 4 ft., \$3.00 each; 4 to 5 ft., \$3.50 each; 5 to 6 ft., \$4.50 each.

Douglas Fir (*Pseudotsuga douglasii*). Large, very rapid growing tree forming a dense pyramid. The foliage is a soft bluish green. 2 to 3 ft., \$2.00 each; 3 to 4 ft., \$2.50 each; 4 to 5 ft., \$3.25 each; 5 to 6 ft., \$4.50 each.

Hemlock - Tsuga

Canadian Hemlock (*T. canadensis*). A medium sized tree of dense growth with rich green foliage; branches droop gracefully. 18 to 24 in., \$1.75 each; 2 to 3 ft., \$2.50 each; 3 to 4 ft., \$3.25 each; 4 to 5 ft., \$4.25 each; 5 to 6 ft., \$5.50 each.

Juniper - Juniperus

Chinese Juniper (*J. chinensis*). Pyramidal in outline, with silvery green foliage. 3 to 4 ft., \$4.00 each; 4 to 5 ft., \$5.00 each; 5 to 6 ft., \$6.00 each.

Greek Juniper (*J. excelsa stricta*). A very symmetrical dwarf evergreen of conical shape; bluish green. 15 to 18 in., \$1.50 each; 18 to 24 in., \$2.00 each; 2 to 3 ft., \$2.50 each.

Irish Juniper (*J. communis hibernica*). Slender and columnar in habit with bluish green foliage. 1½ to 2 ft., \$1.00 each; 2 to 3 ft., \$1.25 each; 3 to 4 ft., \$1.50 each; 4 to 5 ft., \$1.75 each.

Pfitzer Juniper (*J. chinensis pfitzeriana*). A most valuable foundation evergreen. Dwarf in habit, its bluish green foliage is carried on graceful spreading branches; thrives under very unfavorable conditions. 18 to 24 in. spread, \$2.75 each; 2 to 2½ ft., \$3.50 each; 2½ to 3 ft., \$4.00 each.

Plumed Juniper (*J. c. depressa plumosa*). One of the finest creeping forms. The branches bend over to hug the ground, forming a mat of gray-green foliage. Its main distinction is the unusual purplish coloring of the foliage in the fall. 12 to 18 in. spread, \$1.50 each; 18 to 24 in. spread, \$2.00 each.

Savin Juniper (*J. sabina*). Beautiful dark green foliage, with fan-shaped branches. Very hardy. 15 to 18 in., \$1.50 each; 18 to 24 in., \$2.25 each; 24 to 30 in., \$2.75 each.

Spreading Juniper (*J. communis*). A very hardy trailing type with bluish foliage. Valuable for rock planting. 2 to 2½ ft., \$2.50 each.

Swedish Juniper (*J. communis suecica*). Very similar to the Irish Juniper, but much hardier. 2½ to 3 ft., \$1.50 each; 3 to 4 ft., \$2.00 each; 4 to 5 ft., \$2.75 each.

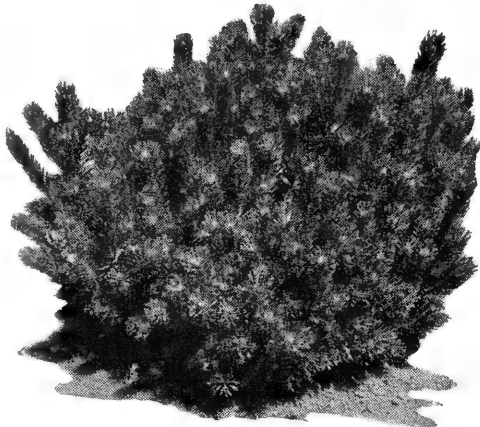

Dwarf Mugho Pine

Pine - Pinus

Austrian Pine (*P. nigra*). A tree of rapid growth with long dark green foliage. A vigorous and rugged grower even under unfavorable conditions. 2 to 3 ft., \$2.50 each; 3 to 4 ft., \$3.50 each; 4 to 5 ft., \$4.50 each; 5 to 6 ft., \$6.50 each; 6 to 7 ft., \$8.00 each.

Dwarf Mugho Pine (*P. montana mughus*). Foliage dark green; very dwarf in habit; very useful as a border or rock plant. 12 to 15 in., \$2.00 each; 15 to 18 in. spread, \$2.50 each; 18 to 24 in. spread, \$3.00 each; 2 to 2½ ft., \$3.50 each.

Red Pine (*P. resinosa*). A vigorous grower with long, rich green needles. 3 to 4 ft., \$4.00 each; 4 to 5 ft., \$5.00 each; 5 to 6 ft., \$6.00 each; 6 to 7 ft., \$7.00 each.

Scotch Pine (*P. sylvestris*). A tree of rapid growth with short, stiff, bluish green foliage. 3 to 4 ft., \$2.50 each.

White Pine (*P. strobus*). A lofty native tree. Silvery green foliage. Does well on sandy soil. 2 to 3 ft., \$2.00 each; 3 to 4 ft., \$3.25 each; 4 to 5 ft., \$4.75 each; 5 to 6 ft., \$5.75 each; 6 to 7 ft., \$7.50 each; 7 to 8 ft., \$9.50 each; 8 to 10 ft., \$13.00 each.

Retinospora (Japan Cypress) - Chamaecyparis

Plume Cypress (*R. plumosa*). Erect branches with side shoots of a plume-like arrangement; graceful, feathery, green foliage. 1½ to 2 ft., \$1.50 each; 2 to 2½ ft., \$1.75 each; 2½ to 3 ft., \$2.00 each; 3 to 4 ft., \$3.00 each.

Golden Plume Cypress (*R. plumosa aurea*). A golden form. 1½ to 2 ft., \$1.50 each; 2 to 2½ ft., \$1.75 each; 2½ to 3 ft., \$2.00 each; 3 to 4 ft., \$3.00 each.

Sawara Cypress (*R. pisifera*). An upright, graceful tree with flattened branchlets; foliage green. 1½ to 2 ft., \$1.75 each; 2 to 2½ ft., \$2.00 each; 2½ to 3 ft., \$2.50 each.

Thread Cypress (*R. filifera*). The long thread-like branches are very pendulous; lateral stems of bright green. 18 to 24 in., \$2.25 each; 2 to 3 ft., \$3.00 each.

Spruce - Picea

Colorado Green Spruce (*P. pungens*). A stately evergreen of symmetrical habit, having sharp, dull needles on horizontal branches. 2½ to 3 ft., \$2.00 each; 3 to 4 ft., \$2.25 each; 4 to 5 ft., \$3.00 each; 5 to 6 ft., \$4.00 each.

Colorado Blue Spruce (*P. pungens glauca*). The well known Colorado Blue Spruce. 18 to 24 in., \$2.75 each; 2 to 2½ ft., \$3.00 each; 2½ to 3 ft., \$3.50 each; 3 to 4 ft., \$4.00 each; 4 to 5 ft., \$6.00 each; 5 to 6 ft., \$7.50 each.

Koster's Blue Spruce (*P. pungens kosteri*). The bluest of all the Spruces. 2 to 2½ ft., \$4.00 each; 2½ to 3 ft., \$4.50 each; 3 to 3½ ft., \$5.00 each; 3½ to 4 ft., \$6.00 each; 4 to 4½ ft., \$7.50 each; 4½ to 5 ft., \$11.00 each; 5 to 6 ft., \$12.50 each; 6 to 7 ft., \$15.00 each.

Dwarf Alberta Spruce (*P. glauca conica*). A beautiful, compact cone-shaped evergreen with dense foliage. Dwarf. 12 to 15 in., \$2.00 each.

Norway Spruce (*P. excelsa*). 2 to 3 ft., \$1.50 each; 3 to 4 ft., \$2.00 each; 4 to 5 ft., \$2.75 each; 5 to 6 ft., \$3.50 each.

Pygmy Spruce (*P. excelsa pygmaea*). This little tree of dwarf and compact habit makes an ideal plant for rockeries. 6 to 8 in., \$1.50 each; 8 to 10 in., \$1.75 each; 10 to 12 in., \$2.25 each.

White Spruce (*P. canadensis*). An upright grower with light silvery green foliage. 18 to 24 in., \$1.00 each; 2 to 3 ft., \$1.50 each; 3 to 4 ft., \$2.00 each; 4 to 5 ft., \$3.00 each.

Yew - Taxus

Canadian Yew (*T. canadensis*). Low, spreading shrub with pale green foliage. Preferable for shady plantings. 15 to 18 in., \$1.75 each; 18 to 24 in., \$2.50 each.

Columnar Yew (*T. cusp. int. columnaris*). This variety grows extremely upright and narrow like the Irish Juniper and can be used in many places where a narrow tree is desired. 15 to 18 in., \$2.00 each; 18 to 24 in., \$2.50 each; 2 to 2½ ft., \$2.75 each; 2½ to 3 ft., \$4.00 each; 3 to 3½ ft., \$6.50 each; 3½ to 4 ft., \$7.50 each.

Dwarf Hedge Yew (*T. canadensis stricta*). Especially adapted for dwarf edging for gardens or border plantings. 12 to 15 in., \$2.25 each; 15 to 18 in., \$2.50 each; 18 to 24 in., \$3.00 each.

Japanese Yew (*T. cuspidata*). One of the most desirable of the low growing evergreens. The foliage is dark green; spreading habit and very hardy. 15 to 18 in., \$2.50 each; 18 to 24 in., \$3.25 each; 2 to 2½ ft., \$4.50 each; 2½ to 3 ft., \$6.00 each.

Upright Japanese Yew (*T. cuspidata capitata*). An upright form of the above. 15 to 18 in., \$2.00 each; 18 to 24 in., \$2.50 each; 2 to 2½ ft., \$2.75 each; 2½ to 3 ft., \$4.00 each; 3 to 3½ ft., \$5.00 each; 3½ to 4 ft., \$5.50 each.

Intermediate Japanese Yew (*T. cuspidata intermedia*). The habit of growth is more dense and the foliage darker than the Japanese. 12 to 15 in., \$2.00 each; 15 to 18 in., \$2.50 each; 18 to 24 in., \$3.75 each.

Dwarf Japanese Yew (*T. cuspidata nana brevifolia*). An excellent dwarf variety with very dark green foliage. 12 to 15 in., \$2.25 each; 15 to 18 in., \$3.00 each; 18 to 21 in., \$3.50 each; 21 to 24 in., \$4.00 each.



Dwarf Japanese Yew



Retinospora plumosa aurea

Evergreen Shrubs

These splendid plants hold their rich green foliage all the year round, and in many varieties make a magnificent showing of bloom. Shaded situations are preferred by most of the varieties.

ANDROMEDA (*Pteris floribunda* (Lily-of-the-Valley Shrub). Beautiful, hardy shrub. In early April it is covered with showy spikes of white flowers. 12 to 15 in., \$1.50 each; 15 to 18 in., \$1.75 each.

DAPHNE cneorum (Rose Daphne). A most attractive, dwarf, almost prostrate shrub. In May, and again in August, it bears beautiful flower clusters of a delightful shade of pink. For rock gardens it is very desirable. 5 to 7 in., 50c each; \$5.50 per doz. 7 to 9 in., 75c each; \$7.50 per doz. 9 to 12 in., \$1.00 each; \$10.00 per doz. 12 to 15 in., \$1.25 each; \$12.50 per doz. 15 to 18 in., \$1.75 each; \$17.50 per doz.

EUONYMUS radicans. Very hardy, dense-growing trailing vine; dull green leaves, with whitish veins; grows rapidly; self-clinging. 40c each; \$4.50 per doz.; \$30.00 per 100.

radicans variegata. Similar in habit to the above. Foliage green and white. 50c each; \$5.00 per doz.

radicans kewensis. The smallest *Euonymus*. The leaves are about ¼ inch wide and a little longer. As a low evergreen ground cover it forms a perfect mat of green. A fine variety for the rock garden, low walls, low slopes and edge of pools. 3-yr., 40c each; \$4.50 per doz. 4-yr., 50c each; \$5.50 per doz.

radicans vegetus. A pretty, low trailing evergreen with aerial rootlets which cling to any support. Has round leaves and produces an abundance of showy red fruits with yellow pods. 2-yr. 75c each; \$7.50 per doz. 4-yr., \$1.00 each; \$10.00 per doz.

HEATHER (*Calluna vulgaris*). The Heathers are compact, low-growing plants, and as such are extremely useful for rockeries. The small foliage is densely arranged around the wiry little stems, and either when in full bloom or in midwinter makes a very pretty picture. 6 to 8 in., 50c each; 8 to 10 in., 75c each.

LEUCOTHOE (*Andromeda catesbaei*). A valuable shrub in shady positions. Flowers are fine, white, and are borne in long, pendulous racemes. 12 to 18 in., \$1.25 each; 18 to 24 in., \$2.00 each.

MOUNTAIN LAUREL (*Kalmia latifolia*). Grows 8 feet high, with broad, glossy green foliage. The rose colored flowers, in large and showy clusters at the ends of the shoots, appear in June. 15 to 18 in., \$1.75 each; 18 to 24 in., \$2.25 each; 2 to 2½ ft., \$3.00 each; 2½ to 3 ft., \$3.50 each.

PACHYSANDRA terminalis (Japanese Spurge). The best ground cover under shrubs of all kinds. Grows only 6 inches high and has dark green foliage. 25c each; \$2.00 per doz.; \$15.00 per 100.

RHODODENDRON carolinianum (Carolina Rhododendron). Leaves rather small, narrow, dark green above, covered with brownish dots beneath; clusters of clear rose-pink flowers in May; very hardy. 12 to 15 in., \$2.25 each; 15 to 18 in., \$2.75 each; 18 to 24 in., \$3.25 each.

White Carolina. 12 to 18 in., \$1.75 each.

catawbiense (Catawba Rhododendron). One of the most beautiful native shrubs and the hardest of all the Rhododendrons. Color rosy purple. 15 to 18 in., \$2.00 each; 18 to 24 in., \$3.00 each; 2 to 2½ ft., \$3.75 each; 2½ to 3 ft., \$6.25 each.

catawbiense compacta. 15 to 18 in., \$3.75 each; 18 to 24 in., \$5.50 each.

maximum (Great Laurel). A well known native of our mountain regions, with great clusters of white or rose-pink flowers in June and July. 15 to 18 in., \$1.75 each; 18 to 24 in., \$2.25 each; 2 to 2½ ft., \$2.50 each; 2½ to 3 ft., \$3.75 each.

VINCA MINOR (Myrtle or Common Pariwinkle). A handsome evergreen trailing plant with showy bright blue flowers borne freely in early spring. A good shade-growing ground cover plant. 25c each; \$2.50 per doz.; \$15.00 per 100.

YUCCA filamentosa (Adams Needle). Handsome, creamy white flowers, much branched and densely packed with bloom, with swordlike foliage. 40c each.

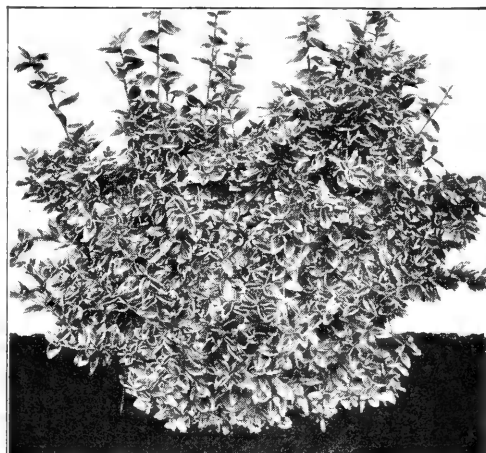

Euonymus Radicans Variegata

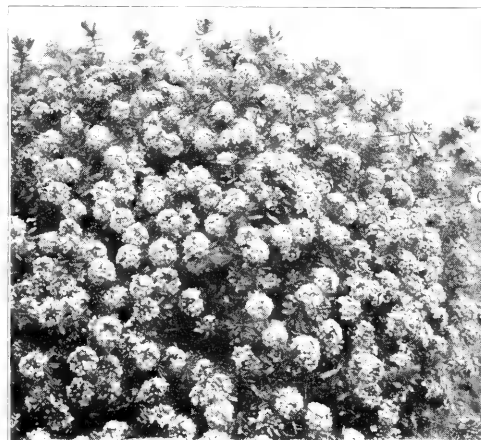

Daphne Cneorum

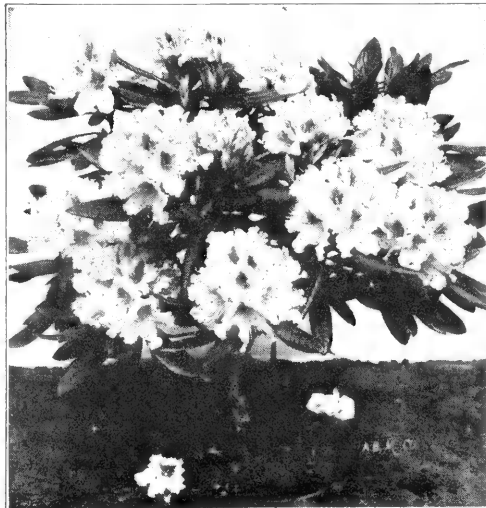

Rhododendron

Fruit Trees

Apples

(STANDARD) Each Doz.
2-year\$1.00 \$11.00

SUMMER VARIETIES

Red Astrachan. Red, large. Aug.
Yellow Transparent. Pale yellow, August.

AUTUMN APPLES

Fameuse, or Snow. Crimson. Nov. to Jan.
Gravenstein. Red striped, large. Oct.
Wealthy. Deep red, white flesh.

WINTER VARIETIES

Baldwin. Red, large.
Cortland. A beautiful red; larger than McIntosh and ripening a month later.
Delicious. Large, red.
McIntosh Red. One of the best, red; Nov., Feb.
Northern Spy. Yellow and red; large.
Rhode Island Greening. Greenish yellow; large.
Roxbury Russet. Medium to large. Dec. to June.
Talman Sweet. Yellow, medium size. Nov. to April.

CRAB APPLES

\$1.25 each

Hyslop. Dark crimson; large.
Transcendent. Yellow and red striped; large.

Cherries

\$1.25 each, \$12.00 per doz.

Black Tartarian. Purplish black; large. June.
Early Richmond. A preserving variety.
Gov. Wood. Yellow and red; large. June.
Montmorency. A large, preserving variety.
Napoleon. Yellow and red; large. July.
Windsor. A large, deep colored variety of good flavor.
Yellow Spanish. Pale yellow, red cheek. June.

Pears

2-yr., \$1.25 each; \$12.00 per doz.

SUMMER VARIETIES

Bartlett. Yellow and large.
Clapp's Favorite. Yellowish green, large.

AUTUMN VARIETIES

Anjou. Greenish yellow. Nov. to Dec.
Beurre Boac. Russet color; large. \$1.50 each.
Seckel. Yellowish russet; small.
Sheldon. Yellowish russet; medium size.

WINTER VARIETIES

Duchess. Very large, yellow, with a dull red cheek.

DWARF PEARS

\$1.25 each; \$12.00 per doz.

Anjou, Bartlett, Clapp's Favorite, Seckel.

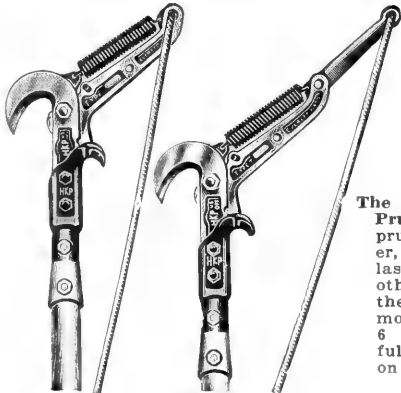

The H. K. P. Pole Pruner

The H. K. P. Pole Pruner. A durable pole pruner that cuts closer, easier, faster, and lasts longer than any other similar tool on the market. Various models and sizes from 6 to 16 ft. Circular fully describing same on request.

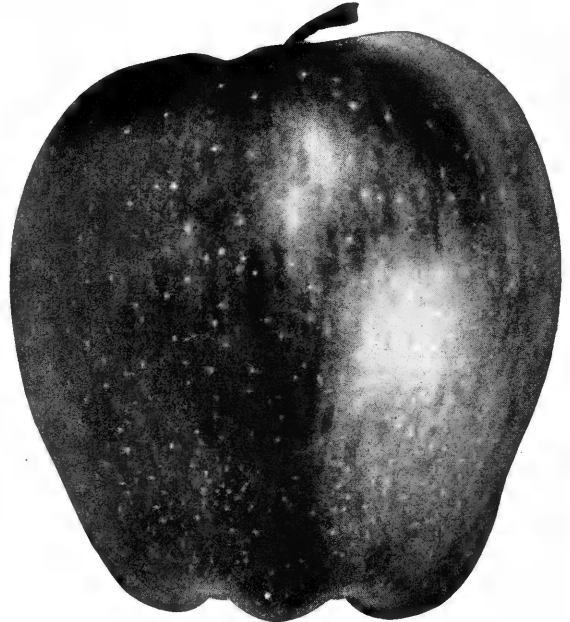

Delicious Apple

Peaches

60c each; \$6.00 per doz.

Belle of Georgia. White, red cheek; large, very late.
Carman. Pale yellow with red blush. Large, with sweet flavor.
Champion. Creamy white, red cheeks; large. Aug. 1.
Crawford's Early. Yellow and red; large. Aug.
Crawford's Late. Yellow and red; large. Sept.
Elberta. Large; light yellow. Aug.
Greensboro. White with red cheek. Early.
J. H. Hale. Large, yellow. Freestone. Sept.
Mountain Rose. Large, red, with white flesh; early.
Oldmixon Free. White and red; large. Sept.

Plums

2-yr., \$1.25 each; \$12.00 per doz.

Bradshaw. A very large, oval; dark violet-red; juicy, sweet and good.
Coe's Golden Drop. Very large; light yellow; rather firm; rich, sweet and good; adheres to the stone.
Damson. Last of September. Small, dark purple; valued for preserving.
Lombard. Medium oval; violet-red, juicy, pleasant and good; very productive.

JAPAN PLUMS

Abundance. Lemon-yellow ground, overspread with bright cherry, and a heavy bloom; large.
Burbank. Large and beautiful; clear cherry-red.

Quinces

\$1.25 each

Apple, or Orange. Large, roundish, bright golden yellow; very productive. Early to late.
Champion. Large, yellow, very productive and ripening very late.

Small Fruits

Grapes

50c each, \$5.00 per doz.

BLACK

Concord. Large, always reliable. Medium.
Moore's Early. Early.
Worden. Large, early.

RED

Brighton. Large, early.
Caco Red.
Delaware. Small, delicious. Late.

WHITE

Green Mountain. One of the best. Early.
Moore's Diamond. Early.
Niagara. Medium.

Blackberries (Transplants)

\$1.00 per doz., \$7.00 per 100.

Eldorado. Extra fine and very hardy; large, sweet berry.
Rathbun. Very large, sweet and delicious.
Snyder. Medium size; very fine. Medium.

Raspberries (Transplants)

\$1.00 per doz., \$7.00 per 100.

Columbian. Purple fruit, delicious for table.
Cuthbert. Medium to large, red, sweet.
Latham. Large, deep red, very productive.
St. Regis Everbearing. Large, bright crimson berries.
Herbert. Large, sweet, bright red.

Cultivated Blueberries

Blueberries require an acid soil. At least three different varieties should be used as the individual plant is not self-fertile.

12-18 in. \$1.00 each, \$11.00 per 10.

18-24 in. \$1.50 each, \$16.00 per 10.

Cabot. Early. Spreading habit.
Concord. Midseason. Tall.
Jersey. Late.
Pioneer. Midseason.
Rancocas. Midseason. Tall.
Rubel. Late. Tall.

Strawberries

Layer plants in spring, \$3.00 per 100, \$28.00 per 1000, except where noted.

Pot-grown plants after August 1st.

Abington. Strong grower and great yielder. The bright red berries are very large, firm and of fine flavor. Early to medium.
Arabine. Extra early, very large, bright red of high quality, very robust grower and heavy cropper.
Barrimore. Large, rich, dark glossy crimson; flesh red and quality excellent. Medium.
Big Joe. A magnificent new Strawberry of robust growth and very prolific. The berries are light crimson in color and very large. Medium.

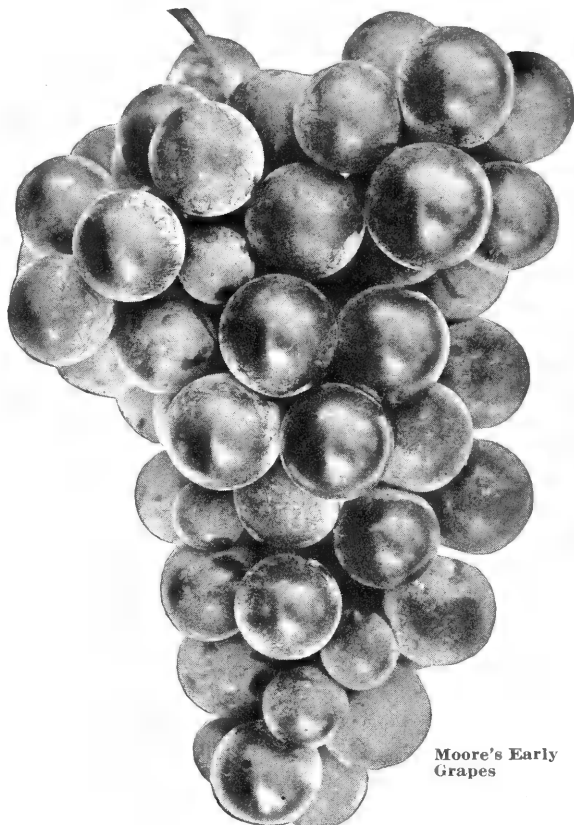

Moore's Early Grapes



Mastodon Everbearing Strawberries

Brandywine. Large, roundish, conical, bright glossy crimson berries, firm and solid; excellent quality and fine flavor. Medium.
Commonwealth. Large, glossy crimson berry, of excellent quality, a great cropper and one of the latest.
Gibson. Very large, deep red, fine flavor. Medium.
Glen Mary. Very large, highly colored, firm, and ranks with the best in flavor. Medium to late.
Golden Gate. New seedling, resembles the Marshall and will succeed where the Marshall fails. It produces strictly fancy, firm fruit clear to the end of the season, of a rich, crimson color.
Judith. A large, medium red, pointed berry; a good market variety; very early.
Marshall. Large rich crimson, fine flavor. One of the most popular sorts. Medium.
Premier. One of the best of the extra early varieties; does well in almost any section; excellent quality; bright red.
Senator Dunlap. Dark red berries of medium size. The flesh is red all through and exceedingly juicy. Early mid-season.
Warren. Dark, blood red, extra size, broad and flattened at tips, borne on large clusters. Medium.

EVERBEARING STRAWBERRIES

Mastodon. Truly a Wonderberry, in size, flavor and yield. \$4.00 per 100.
Progressive. The fruit is rich and sweet, a deep red inside and out; of good medium size and quite firm. \$3.50 per 100.
Superb. Perfect blossoms. Enormous crops in June, and in September. It does not fruit on new runners. \$3.50 per 100.

All Prices Subject to Change Without Notice

Farm, Garden and Lawn Requisites, Tools, Etc.

Asparagus Buncher. Makes bunches of size usually sold in Boston market. \$5.00 each.

Asparagus Knife. Also used as a weeder. 25c to 50c each. Axes. Warranted steel, Witherell's extra quality, handled. \$2.50 to \$3.50 each.

Bamboo Poles. 20 feet. 50c each, \$5.00 per doz.

Bands, Rubber. For bunching Asparagus, Celery, Beets, Radishes, etc. Use in place of twine or tape. In 1-lb. boxes, \$1.25 per lb.

Bars, Crow. Solid cast steel. Per lb. 15c.

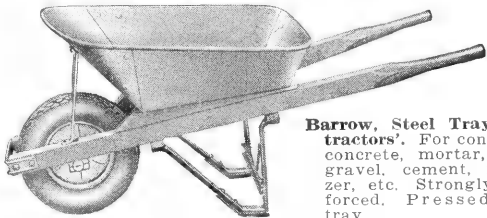

Barrow, Steel Tray Contractors'. For conveying concrete, mortar, sand, gravel, cement, fertilizer, etc. Strongly reinforced. Pressed steel tray.

No. 154—Capacity 3½ cu. ft., with steel wheel \$9.00
No. 21—Capacity 2½ cu. ft., with steel wheel 6.00

PLANT TRAY OR RUBBER SAUCERS

See page 87 for description and prices.

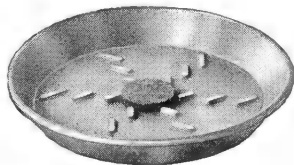

CLYMER BIRD FEEDER



Enjoy bird friendship all winter long. Invite the birds to come to your garden for their daily repast. Fasten several of these handy feeders where you can watch your daily visitors enjoying your hospitality. They also make appreciated gifts to your friends.

In the winter season all the insects and worms are entirely gone. The wild seeds are very scarce and sometimes covered with snow.

The Feeding Station contains suet and a special mixture of wild seeds that are proper for the diet of wild birds. The seeds and grains in the Station are more than welcome to our wild bird life.

Easily suspended from any branch and therefore accessible only to birds. Carefully made with all wooden parts tightly fitted without the use of nails. Complete with special grain-suet food. Mailing weight 4 lbs. \$1.00. Grain-suet refills 35c each, 3 for \$1.00. Mailing weight 2 lbs. each; 5 lbs. for three.

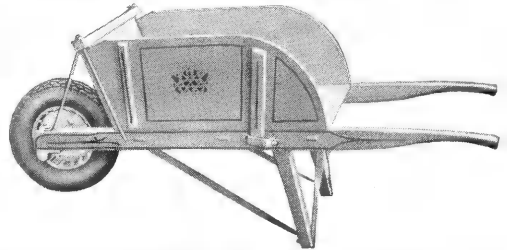

Barrow, New England Garden. This is a strong, well-made barrow; the frame is made from best seasoned timber, nicely painted and striped, it has a six-spoke, steel axle, wood wheel. We consider it the best garden barrow manufactured. Three sizes. No. 64, medium, \$8.00; No. 65, large, \$9.00; No. 66, extra large, \$10.00.

Barrows, equipped with 16x4 inch pneumatic rubber tire wheels, \$8.00 extra.

Barrow, Greenhouse. Made especially for greenhouse. Long narrow bodies with wood wheel. \$10.00.

Barrow Leaf Rack. Made of galvanized wire, with wood bottom, capacity ten bushels. \$10.00.

HANDY-CART



Of endless utility about the house, garden, lawn, etc. It is the last word in convenience for the home owner. Just tip it down and rake grass cuttings, leaves or what have you, right into the cart, then tip it back and you have a full load. Sturdily supported sheet metal body with 10-inch disc wheels and

rubber tires. Two sizes: No. 1, 2 cu. ft. cap. \$4.75; No. 2, 3 cu. ft. cap. \$6.75. Either cart equipped with 11-inch wheels and puncture-proof semi-pneumatic tires, \$1.50 extra.

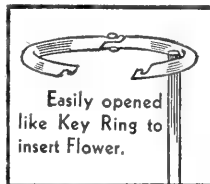

Easily opened like Key Ring to insert Flower.

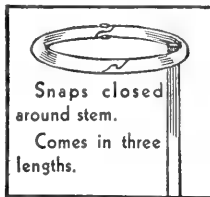

Snaps closed around stem. Comes in three lengths.



Handy Flower Holder

To beautify gardens and potted plants. Easily opened like key ring to insert flower, snaps closed close around stem. Made of strong, durable steel wire. Comes in 3 lengths: 24-inch, doz., \$1.00; 36-inch, doz., \$1.25; 48-inch, doz., \$1.50.

Baskets, Tomato or Pansy. Wire handles, also used for fruit as well as plants. 100 1000
3-quart size \$4.00 \$35.00
2-quart size 3.00 28.00

Baskets, Picking. For gathering fruit or vegetables. Swing or stationary bail. 1 pk. 75c, ½ bu. \$1.00, 3 pks. \$1.25.

Baskets, Shepherd. 1 bu. \$2.50 each; 2 bus. \$4.00 each.

Baskets. For holding leaves. 4 bus. \$4.00 each.

Baskets, Vegetable. ¼ bu. \$1.00 each; ½ bu. \$1.25 each; ¾ bu. \$1.50 each; 1 bu. \$1.75 each.

Baskets, Wire Hanging. Either round or flat bottom. 6 in. 30c each; 7 in. 40c each; 8 in. 50c each; 10 in. 60c each; 12 in. 70c each.

Bill Hooks. For heavy pruning. English. \$3.50.

Boxes for Cut Flowers. The following sizes are kept in stock.

No.	Length	Width	Depth	Doz.	100
1	18 in.	5 in.	3 in.	\$1.00	■ 6.00
2	21 in.	5 in.	3½ in.	1.20	7.00
3	24 in.	5 in.	3½ in.	1.40	8.00
4	30 in.	5 in.	4 in.	1.60	9.00
5	21 in.	8 in.	5 in.	1.80	10.00
6	24 in.	8 in.	5 in.	2.00	11.00
7	28 in.	8 in.	5 in.	2.25	13.00
8	36 in.	8 in.	5 in.	2.50	16.00

Corrugated Shipping.

Size	Inches	Each	Doz.
B	24x12x6	\$0.50 \$5.00
C	30x12x760 6.00
D	36x12x970 7.00
E	40x15x980 8.50
F	48x15x9	1.00 10.00

Farm, Garden and Lawn Requisites, Tools, Etc.

Burlap. For putting around trees to trap gypsy moths. 8 in. wide, 10c per yard; 100 yards, \$9.00. 40 in. wide, 22c per yard; piece about 100 yards, 18c per yard.

Burning Brands. For making tools, etc. Six letters or less, \$5.00; each additional letter, \$1.00.

Bush Hooks. Strapped-eye handle, \$2.25.

Carbarnet Support, Excelsior. Heavy galvanized wire. In two sizes, 13 in., \$3.00 per 100; 20 in., \$3.50 per 100. One of each length makes a complete plant support.

Cotton Wadding. Large sheets, for protecting plants and flowers from frost, 12c each, \$1.25 per doz., \$8.00 per 100.

Celery Wrappers. Best quality parchment paper, printed. 11x14 in., pkt. 1000 sheets, \$3.50.

Dibbles. Steel points, wooden or iron handle, 85c each.

Edging Knife, American. \$1.25. Long or D Handle.

Edging Knife, English. \$3.00 each. Handles, extra, 50c.

Electric Tape. For mending hose, etc. 40c per coil.

Flower Pot Saucers, Rubber. Breakproof — leakproof. made of durable rubber compound with cleated bottom to allow water to drain from pot. Will not mar polished surfaces. Illustrated, page 86.

	Each	Doz.
No. 1, takes up to 5 in. pot	\$0.25	\$ 2.50
No. 2, takes up to 8 in. pot	.50	5.00
No. 3, takes up to 10 in. pot	.80	8.50
No. 4, takes up to 12 in. pot	1.25	13.50

Flower Pot Saucers, Earthen.

Diam.	Each	Doz.	Diam.	Each	Doz.
4 in.	\$0.05	\$0.40	10 in.	\$0.25	\$2.50
5 in.	.06	.50	12 in.	.35	4.00
6 in.	.08	.75	14 in.	.55	6.00
7 in.	.10	1.00	16 in.	.85	9.50
8 in.	.15	1.50	18 in.	1.10	12.00

Hews Flower Pot. Standard. Measurement from inside to inside. Width and depth equal.

Inches	Doz.	100	Inches	Doz.	100
2	\$0.25	\$1.50	7	\$2.25	\$17.00
3	.35	2.50	8	3.25	24.00
4	.50	3.75	9	4.50	35.00
5	.90	6.75	10	6.50	50.00
6	1.40	10.00	12	12.00	90.00

Flower Pot Hanger, Krich's Perfect, No. 1 will fit from 3 1/2 to 5 in. pots, 60c per doz. No. 2 will fit from 5 to 8 in. pots, 70c per doz. No. 3 will fit from 8- to 12- in. pots, 80c per doz.

Bulb and Seed Fans, Round.

Size	Each	Doz.	Size	Each	Doz.
6 in.	\$0.15	\$1.50	9 in.	\$0.50	\$4.50
7 in.	.20	2.25	10 in.	.65	6.50
8 in.	.30	3.25	12 in.	1.25	12.00

Flower Pots, Neponset Green. Made of tough waterproof paper, eliminating breakage. Superior to any other pot on the market for the actual growing and transplanting of plants. Not less than one case at 1000 price.

Inches	In case	Doz.	100	1000
2 1/4	1000	\$0.15	\$0.75	\$ 6.50
2 1/2	1000	.20	1.00	7.50
3	1000	.25	1.25	9.00
3 1/2	1000	.30	1.50	12.00
4	500	.40	2.00	15.00
5	500	.50	2.50	20.00
6	500	.60	3.00	24.00

Flower Pots, Neponset Red. For storage, transplanting, and shipping. Specially treated and water-resistant. Not less than one case at 1000 price.

Inches	In case	Doz.	100	1000
2 1/4	1000	\$0.10	\$0.40	\$ 3.50
2 1/2	1000	.15	.50	4.50
3	1000	.20	.60	4.50
3 1/2	1000	.25	.75	5.75
4	500	.30	.90	7.00
5	500	.35	1.00	9.00
6	500	.40	1.25	12.00

Flower Vases, Galvanized Iron. Strong, light, durable, made of good material with heavy hoop at base of can to reinforce bottom of vase. These vases are finished in a moss green enamel baked on.

No.	Top.	Diam.	Bot. Diam.	Hght.	Each	Doz.
5	7 1/2	in.	5 1/2	in.	11 in.	\$1.50 \$16.00
6	7	in.	5 1/2	in.	17 in.	1.75 19.00
7	8	in.	6 1/2	in.	11 in.	1.50 16.00
8	9	in.	7 1/2	in.	12 in.	1.75 19.00
9	9	in.	7 1/2	in.	17 in.	2.00 22.00
10	6 1/2	in.	5	in.	14 in.	1.50 16.00
11	5 1/2	in.	4 1/2	in.	15 in.	1.50 16.00
12	5	in.	4	in.	9 1/2 in.	1.35 15.00

Floral Tools, "American." These tools are not toys, but serviceable tools, of high grade material, well made and finished.

No. 4, P. S. F. 4-Piece Set: Shovel, Rake, Hoe, and Spading Fork	\$3.65
No. 3 P. F. 3-Piece Set; Shovel, Rake and Hoe	2.65
Extra Rakes for above set	Each .75
Extra Spading Forks	Each 1.10
Extra Hoes	Each .90
Extra Floral Shovels	Each 1.00

Forks, Ensilage. 8 tine, D handle, strapped	Each \$3.00
Forks, Hand. For transplanting, American	.50
Forks, Hand. For transplanting, English	\$1.25 to 2.25
Forks, Hay. 4 to 6 ft., bent handles	\$1.50 to 2.25
Forks, Manure. 4 tine, mal. D handle, strapped	1.85
Forks, Manure. 5 tine, mal. D handle, strapped	2.15
Forks, Manure. 6 tine, mal. D handle, strapped	2.40
Forks, Manure. 4 tine, wood D handle, strapped	2.15
Forks, Manure. 5 tine, wood D handle, strapped	2.40
Forks, Manure. 6 tine, wood D handle, strapped	2.65
Forks, Manure. 4 tine, long handled, strapped	1.85
Forks, Manure. 5 tine, long handled, strapped	2.15
Forks, Manure. 6 tine, long handled, strapped	2.40
Forks, Spading. 4 tine, long handled, strapped	1.85
Forks, Spading. 4 tine, mal. D handle, strapped	1.85
Forks, Spading. 4 tine, wood D handle, strapped	2.15
Forks, Spading. 5 tine, mal. D handle, strapped	2.40
Forks, Stone. 8 tine, mal. D handle, strapped	2.75
Garden Lines, Braided. 100 ft., \$1.25, 200 ft., \$2.25.	
Garden Line Reels. Small \$1.50, large \$2.00 each.	
Glass Cutter. 25c and 50c each.	

Glaziers' Points (Perfection). Will stop glass from slipping. made of steel wire galvanized. Double point. Per box of 1000, No. 2, 75c; No. 2 1/2, 85c.

Glaziers' Points (Zinc City). Made of zinc. Will not rust. In three sizes, 1/2, 3/4 and 7/8 in. long. Each size, 65c per lb.

Gloves, Gardeners' Pruning. With gauntlets, \$2.00 per pair; without gauntlets, \$1.50 per pair.

Grafting Knife, or Chisel. All steel, \$1.25 each.

Grafting Wax. 1/4 lb. 20c, 1/2 lb. 35c, lb. 60c.

Grass Hooks, or Sickles. English, No. 2, \$1.00 each; No. 4, \$1.25 each; American, 50c and 75c each.

Grindstones, "Nova Scotia." Mounted on selected hardwood frames. Sizes vary from 20 in. to 30 in. in diameter. Prices from \$20.00 to \$30.00 each.

Wayward Vine Guide and Support

New—Practical.

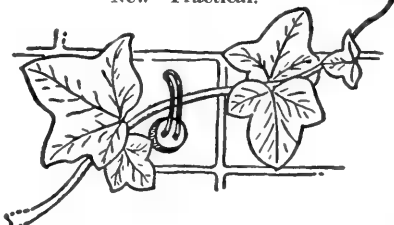

For training and supporting Ivy, Small Fruiting Trees, and all other Vines, etc., on brick walls or any other surface without defacing it.

Price: \$1.00 for box of 25, including cement. Special price on quantity lots. Red—White—Grey.

Hammer, Nail. Adze eye, bell face.	\$1.00 to \$1.50 each.
Hammer, Stone Striking. Solid cast steel.	25c per lb.
Hatchet, Barrel.	\$1.00 to \$1.50 each.
Hatchet, Axe Pattern.	\$1.25 and \$1.50 each.
Handles, Axe. Extra quality hickory.	75c each.
Handles, Hammer. Extra quality hickory.	50c each.
Handles, Pick. Extra quality hickory.	75c each.
Handles, Hay Fork. Extra quality ash.	50c to \$1.00 each.
Handles, Hoe. Extra quality ash.	35c each.
Handles, Manure Fork.	75c to \$1.25 each.
Handles, Shovel and Spade.	75c each.
Handles, Rake.	50c each.
Hoes, Nurserymen's Two-pronged Steel.	\$2.50 each.

Farm, Garden and Lawn Requisites, Tools, Etc.

Hoes, Boothby-toothed. \$1.50 each.

Hoes, Humphrey. \$1.25 each.

Hoes, American Scuffle, Handled. 8 in. \$1.35.

Hoes, English or Dutch Scuffle. 11 in., \$1.00; 12 in., \$1.10; 13 in., \$1.25; 14 in., \$1.35; 15 in., \$1.50; 16 in., \$1.65; 17 in., \$1.75 each. Handled, extra 50c.

Hoes, Grading. 7 in. blade, 4 ft. handle. \$2.50 each.

Hoes, Handy Weeding. This steel weeding blade is only 4 in. long by 3/4 in. wide, but is just right for stirring soil about plants in the rockery. Hardwood handle. Price, 65c.

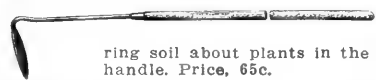

ring soil about plants in the rockery. Hardwood handle. Price, 65c.

Hoes, Garden, Socket Draw. 11 in. \$1.35 each.

Hoes, Meadow. 9 in. \$1.35; 10 in. \$1.50 each.

Hoes, Warren. \$1.50 each.

Hoes, Mortar or Street. 10 in. \$1.75 each.

Hoes, Ladies' and Boys'. 90c and \$1.10 each.

Hoes, Onion. \$1.25 each. Square or round top.

Hoes, Weeding. 6 tooth. \$1.00 each.

Hose, Rubber Garden, "Dreadnaught Brand." A braided hose made of the best materials. Does not kink. We offer this in 25 and 50 ft. lengths coupled; also in continuous lengths of 500 feet. 1/2 in. at 20c per ft.; 3/4 in. at 22c per ft.

Hose Reels. All metal, strong, substantial hose reels for gardens or lawns. Made with high wheels, almost indestructible.

No. 1, holding 100 ft., \$5.00 each.

No. 2, holding 150 ft., \$6.00 each.

Hose Connection, Shut-off. For use with any nozzle that has no shut-off where one is desired. \$1.25 each.

Hose Connection, Slamese. \$1.00 each.

Hose Couplings. 1/2, 3/4 and 1 in., per set, 30c each.

Hose Mender (Hudson's Pattern). Wizard sheet brass tubes. Substantial yet light in weight. Does not obstruct water way of hose. 1/2, 3/4 and 1 in. 5c each, 50c per doz. Wires, 25c per doz., \$1.75 per 100.

Hose Mender, Cooper's. Made of heavy brass, requires no wires or pliers to adjust it. 10c each, \$1.00 per doz.

Hose Menders, Perfect Clutching. In one piece, doing the work of the mender tube and two clamps ordinarily used. 1/2, 3/4 and 1 in., 15c each, \$1.25 per doz.

Hose Clamps. Made of galvanized steel with screw adjustment. 1/2 and 3/4 in., 5c each, 50c per doz.

Hose Reducers. For connecting 1/2 in. and 3/4 in. hose couplings with Bordeaux or Vermorel nozzles. 35c each.

Hose Nozzle, Bordeaux Spray. \$1.25 each.

Hose Nozzle, New Boston. Will throw a coarse or fine spray or a large or small stream. 75c each.

Hose Nozzle, New Rain King. Chrome plated. Precision tooled from solid brass. Leak-proof, rust-proof. Quickly set for any spray desired. 65c each.

Hose Nozzle, Rose Spray. For greenhouse, flower garden, hotbed, etc. Heavy brass, 1 in. face, \$1.00 each; 4 in. face, \$1.25 each. Light brass, 3 in. 75c each; 4 in. \$1.00 each. "Greenhouse," with coarse and fine 4 in. spray, \$2.50 each.

Hose Nozzle, The Paradise Hydro-Spray. The syringing nozzle with the washing spray is positive in its action; is of solid brass construction for control of red spider and mealy bug on chrysanthemums, pompons, sweet peas, carnations, geraniums, roses, etc.

10-inch size with two different sizes oriphic tips, \$3.00. 18-inch size with two different sizes oriphic tips, \$3.50. Oriphic tips extra, 50c.

Hose Nozzle Holder "Aquamatic." Any hose nozzle can be attached; entirely of brass. By a pressure of the fingers on the handle, the spray is turned on, by releasing the pressure the spray automatically shuts off. \$1.75 each.

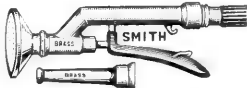

Hose Washers, Rubber. For 1/2 in. and 3/4 in. hose. Doz. 10c. 1/4 lb. 35c, lb. \$1.00.

Knives, Budding and Pruning. Imported. In various styles, \$1.50 to \$5.00 each.

Labels, Copper. Made of copper and copper wired. Indestructible and always legible. No. 1, 3 1/2 x 1/4 in., \$2.00 per 100; No. 2, 5 x 1 1/4 in., \$2.50 per 100.

Labels, Wood. For plants and trees.

	Plain or Painted	Plain	Painted
4 in. Pot Label	100	1000	1000
5 in. Pot Label	0.30	1.80	2.20
6 in. Pot Label	.35	2.00	2.40
7 in. Pot Label	.40	2.25	2.75
8 in. Garden Label	.85	6.00	7.75
10 in. Garden Label	1.00	7.50	9.00
12 in. Garden Label	1.35	10.50	12.00
3 1/2 in. Tree Label	.25	1.50	2.00
3 1/2 in. Tree, iron wired	.30	2.00	2.50
3 1/2 in. Tree, copper wired	.35	2.25	2.70

Labels, The Perfect Garden Label. Marked with ordinary lead pencil this label is permanent in all garden conditions above or under the soil. This feature has been thoroughly tested. The material is indestructible. The beautiful cool gray-green color blends perfectly with foliage, soil and rocks. They should be set deep in the soil with only the marking space showing. Thus they are inconspicuous and do not interfere with weeding and cultivating. Any part of the label may be used as marking space for extensive notes. Markings are erasible with pencil eraser. Tie-on labels are supplied with wires in convenient bundles ready bent for attaching.

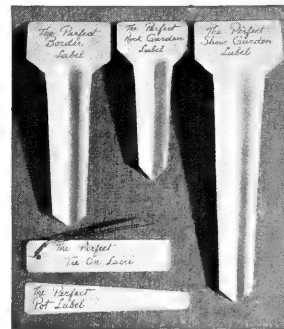

Border size, 5 in. labels, 12, \$1.00; 25, \$2.00; 100, \$7.75.

Rock Garden size, 4 in. labels. 12, 90c; 25, \$1.75; 100, \$6.75.

Show Garden size, 7 in. labels. 12, \$1.25; 25, \$2.50; 100, \$9.50.

Tie-on label 3/4 x 3 1/2 in., with wires 50, \$1.75; 100, \$3.00. Pot label, 3/4 x 4 in., tapered. 50, \$1.50; 100, \$2.50.

Hotkaps

Used extensively not only to protect plants against frost, but shields young plants from wind and insects. In packages as follows: 25 Hotkaps and setter, 50c; 100 Hotkaps with metal setter and steel tamper, spec. pkg., \$2.65; 250 Hotkaps with metal setter and steel tamper, spec. pkg., \$3.35; 1000 Hotkaps only, pkg., \$10.25. Special descriptive matter on request.



Mats, Hotbed. Made by hand of the best rye straw. Size 6x6, \$3.25; 6x3, \$2.00.

Mats, Hotbed. 76x76 in. Covers two sash, made of heavy cotton or duck, filled and quilted. \$5.50 each.

Mattocks. Short cutter or grub hoe. 11 lbs. \$1.00 each.

Mattocks, Long Cutter. Extra quality. \$1.50 each.

Mattocks, Pick. Extra quality. \$1.25 each.

Melon Nets. For supporting Melons in the greenhouse. 25c each, \$2.50 per doz.

Mole Traps, "Little Giant." \$1.00 each.

Oilers. With spring bottom. 25c to 75c each.

Oil, Harvester. For mowers, reapers, etc. Gal. \$1.25.

Fails, Stable. Heavy galvanized iron. 10 qt., 50c, 12 qt. 60c, 14 qt. 75c.

Paper, Green Waxed. Sheets 12x18 in., lb. 50c; ream, about 3 lbs., \$1.25. Sheets, 24x36 in., lb. 50c; ream, \$4.00.

Paper, White Tissue. Sheets 20x30 in., lb. 40c; ream, about 7 lbs., \$2.00. Sheets 24x36 in., lb., 40c; ream, \$3.00.

Paper, White Waxed. Sheets 12x18 in., lb. 50c; ream, about 5 lbs., \$2.00. Sheets 24x36 in., lb., 50c; ream, \$4.00.

Paper, White Wrapping. Sheets 24x36 in., lb. 20c; ream, about 40 lbs. 18c per lb.

Pencils, Indelible Label. With point protector. Black or blue, 20c each. (Wolff's English Garden.)

Picks, Contractor. Best quality, \$1.50 each.

"TWIST-EMS"

The new Handy Plant-Tie. "Twist-Ems" are deep green, strong tapes with non-rusting wire reinforcing that makes perfect plant ties. Just a simple twist of the wrist and plant is tied to its stake or support.



Box of 250, 4-inch length, 25c.

Box of 125, 8-inch length, 25c.

Farm, Garden and Lawn Requisites, Tools, Etc.



Plant Tubs, Cedar. Regular heavy style with drop handles and legs, nicely painted green with three iron hoops, used for ferns, palms, and other large plants. Our plant tubs are treated with a non-toxic solution to guard against decay.

No.	Top		Bottom		Each
	Diam.	Depth	Diam.	Depth	
1	23 3/8"	22"	20 1/2"	22"	\$11.00
2	21"	20"	18 7/8"	20"	10.00
3	18 11/16"	18"	16 7/8"	18"	8.00
4	16 1/2"	16"	14 7/16"	16"	6.50
5	14 7/16"	14"	13 1/8"	14"	5.85
6	12 7/16"	12"	10 7/8"	12"	4.65

Sturdy and Strong Lasts for Years

Tubs, Richmond Cedar. Strongly made of selected white cedar and bound with electric-welded wire; painted green. Without handles.

No.	Diam.	Each	No.	Diam.	Each
6	11 in.	\$1.25	10	15 in.	\$2.25
7	12 in.	1.50	11	16 in.	2.75
8	13 in.	1.75	12	17 in.	3.25
9	14 in.	2.00	13	18 in.	3.75
			14	19 in.	4.50

Plant Sprinklers, Rubber. 50c to \$1.50 each.

Poles, Wooden. 12 ft. long. Used for pruning and tree painting. 65c each; \$7.00 per doz.

Potato Hooks. Steel shank, ▣ tine, \$1.50; ▢ tine, \$1.75.

Potato Digging Fork. ▣ tine, \$2.00.

Pruner, Standard Tree. Operated by a lever, to which the blade is connected by iron rod, 6-ft. pole, \$2.00; ▣ ft. pole, \$2.25; 10-ft. pole, \$2.50; 12-ft. pole, \$2.75; 14-ft. pole, \$3.00; 16-ft. pole, \$3.50 each. Extra blades, 25c each.

Pruner, Telephone Tree. Without pole. A pole of any length to suit requirements can be inserted in the socket. It is operated by a cord tied in the end of lever. \$2.00 each.

Putty Bulb. For glazing greenhouse sash. \$1.50 each.

Raffia. The best material for tying. Soft, pliable and strong. 50c per lb.

Raffia, Green. For tying plants, etc., \$1.25 per lb. pkg.

Rakes, Bamboo, Reinforced. Fan shape, 18 in., 65c; 24 in., \$1.00; 30 in., \$1.25, each.

Rakes, Brume. Steel, fan-shaped rake; used as a broom; strong and durable. \$1.25 each.

Rakes, Hay, Wood. Extra quality, three bow, \$1.10 each.

Rakes, Lawn, Wood. Extra quality, three bow. \$1.25 each.

Rakes, "Lawncomb." New socket pattern. 24 tooth. \$1.35 each.

Rakes, Gumfinger Lawn Rubber. The teeth are live, resilient rubber, stiff enough to rake clean, but flexible enough not to tear or uproot the grass. Rakes clean over rough surface. The rubber teeth adjust themselves to every irregularity in the ground. Light and easily handled. No risk of injury if rake is left with prongs turned upright. Made in five sizes: 8 in., 75c; 12 in., \$1.00; 16 in., \$1.25; 20 in., \$1.50; 24 in., \$1.75.

Rakes, Steel Garden. Long teeth, 10 teeth, \$1.10; 12 teeth, \$1.25; 14 teeth, \$1.35; 16 teeth, \$1.50; 18 teeth, \$1.65.

Rakes, Steel Lawn. Short teeth. 12 teeth, \$1.50; 14 teeth, \$1.65; 16 teeth, \$1.75; 18 teeth, \$1.90.

Sash, Hotbed. Well made from thoroughly seasoned lumber and glazed with double thick glass. Frame 1 1/2 in. 3x6 ft., \$7.50 each. Crating extra at cost.

Saws, Cross Cut, Two Man. Filed and set, ready for use. 5 ft., \$5.00 each. Handles, 50c per pair.

Saws, Cross Cut, One Man. With supplementary handles. 3 ft., \$3.50; 3 1/2 ft., \$4.00 each.

Saws, Pole Pruning. \$2.00 to \$3.50.

Saws, Pruning. Single and double edge. Extra refined spring steel. 18 in., \$1.75; 20 in., \$2.00 each.

Saws, Wood (Buck). Complete, \$2.00 each.

Scissors, Flower. For cutting and holding flowers. 7 in. \$2.00 each.

Scissors, Grape or Vine. For thinning the bunch. Nickel-plated. 7 in., \$2.00 each.

Scoops, Coal. Extra quality. No. 2, \$2.00; No. 3, \$2.25; No. 4, \$2.50; No. 5, \$2.75; No. 6, \$3.00 each.

Scythes, "Witherell's" Finest Cutlery Steel. Fully warranted. \$2.25 each.

Scythes, Broad English or Lawn. \$3.50 each.

Scythes, Heavy Bush. \$2.50 each.

Scythes, Weed or Bramble. \$2.50 each.
Scythe Snaths. \$2.00 each; bush, \$2.25.
Scythe Stones, Carborundum. 50c each.
Scythe Stones, English Round. Talacre, 50c each.
Scythe Stones, "Manchester." 20c each.
Seed Sower, "Cahoon." Best machine for sowing broadcast, grass seed, oats, barley, etc. \$5.00 each.
Silkline (Smilax Thread). Spools 40c each, box of 12 spools, \$3.00.

Shears, Wiss Grass. Number 5600R, \$1.50.

Shears, Wiss-Clipper Grass. Number 700, \$1.40.

Shears, Wiss-Hedge. New shock-proof (English pattern). 8 1/2 in., \$3.25 each; 9 1/2 in., \$3.50 each.

Shears, Wiss Pruning. Various styles. From \$1.00 each to \$4.50 each.



Branch or Lopping Shears

The Forester. (Three power.) Latest, and considered the cleanest, easiest and fastest cutting shear manufactured.

No. 1. Cuts 1-inch diameter. Length 20 inches \$5.00
No. 2. Cuts 1 1/2-inch diameter. Length 27 inches 6.00
No. 3. Cuts 2-inch diameter. Length 34 inches 7.00

Shears, Grass Border. Long handle, ▣ in. blade, \$6.50; 9 in., \$7.00; 10 in., \$7.50 each. Long handle wheel, 9 in. blade, \$7.50 each.

Shears, Grass or Sheep. \$1.00. English extra quality, \$2.50.

Shears, Hedge or Grass. English pruning notch. 8 in. blade, \$4.50; 9 in., \$4.75; 10 in., \$5.00 each.

Shears, Lawn or Grass. Long handle, ▣ in., \$7.00 each.

Shears, Dahllia or Root. Imported. \$5.00 each.

Shears, Ladies' Hedge. American, 6 in., \$1.50; English, \$3.00.

Shears, Ladies, Pruning. ▣ in. rose, \$2.00 each.

Shears, German Pruning. Nickel-plated, lock nut, volute spring. 8 in., \$3.00; ▣ in., \$3.50; 10 in., \$4.00 each.

Shears, Pruning, French. With wheel spring, polished, 8 in., \$2.50; ▣ in., \$3.00; 10 in., \$3.50. Extra springs, 50c.

Shears, Grass. Doo-Klip, long handle (32 in.) with wheels, \$3.00. Excellent for trimming.

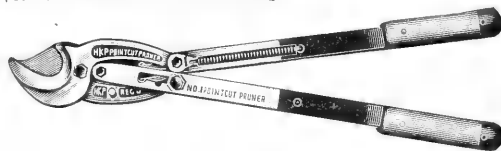

Pointcut (Three Power). The new Pointcut Pruner meets all pruning requirements, completely and satisfactorily.

No. 1, 20 in., \$5.00; **No. 1,** 24 in., \$5.10; **No. 1,** 27 in., \$5.20.

Shears, "Cyclone" Hedge Trimmer. Faster cutting, more uniform trimming, easy to operate. Eliminates slow, tiresome trimming of hedges and assures even and uniform results. Frequent trimming is made possible due to the speed and ease of operation, resulting in beautifying and strengthening the hedge. The Cyclone weighs only 3 lbs. and is designed to be self-balanced, allowing for straight, level trimming. \$6.00 each.

Shovels, Snow. Wooden and steel. 75c to \$1.50 each.

Shovels, Superior Steel. Round or square pointed, D or long handle. No. 2, \$2.50; each; No. 3, \$2.75 each.

Shovels, Market Gardeners'. Light weight for banking celery, etc. Long handle. \$2.00 each.

Sod Lifter. Useful for cutting under sod as it is being rolled. English, \$8.00; American, \$4.00.

Spades, Superior Steel. Extra quality. Either D or long handle. No. 2, \$2.50 each.

Farm, Garden and Lawn Requisites, Tools, Etc.

Stake Fasteners. Galvanized, rustproof wire. Hold the stakes and cross wires firmly.

Eureka. Small and light. Pkg. of 1000, \$3.00.
Everlasting. Heavy and strong. Pkg. of 1000, \$4.50.

Wire Plant Ties. Pkg. of 1000, \$2.00.

Stakes, Japanese Bamboo Garden. Very strong and durable 5/8 to 3/4 in. in diameter. 4 ft., 50c per doz., \$4.00 per 100. 6 ft., 75c per doz., \$5.50 per 100. 8 ft., \$1.00 per doz., \$7.00 per 100.

Stakes, Japanese Cane, Green. Small and inconspicuous, but strong and useful for plants.

	Doz.	100	1000	Doz.	100	1000
1 1/2 ft.	\$0.12	\$0.50	\$2.50	3 1/2 ft.	\$0.25	\$1.00
2 ft.15	.65	3.25	4 ft.30	1.25
2 1/2 ft.18	.75	4.50	5 ft.35	1.50
3 ft.20	.90	5.50	6 ft.40	2.00
6 ft., plain, 40c per doz.,			\$1.75 per 100,			\$14.00 per 1000
8 ft. plain, 50c per doz.,			\$2.50 per 100,			\$22.00 per 1000.

ADJUSTO PLANT SUPPORTS

Unexcelled for Tomatoes, Dahlias, Delphiniums, Hollyhocks, Etc.

Consists of a sturdy 3/8 in. square stake, pointed at one end, stained green and equipped with a strong, green enameled spring wire loop, adjustable to any height with growth of plants. Adjusto Supports are usable for years. Prices: 3 ft. height, \$2.50 per doz.; 4 ft. height, \$2.75 per doz.; 5 ft. height, \$3.00 per doz.; 6 ft. height, \$3.25 per doz.

Stakes, Garden, Painted Green. For house, greenhouse, and conservatory.

Light Round Stakes

Ft.	Doz.	100	Ft.	Doz.	100
1 1/2	\$0.30	\$2.25	3 1/2	\$1.25	\$8.50
2	.50	3.50	4	1.50	11.00
2 1/2	.70	5.00	5	2.25	16.00
3	1.00	7.00			

Heavy Round Stakes

Ft.	Doz.	100	Ft.	Doz.	100
3	\$1.75	\$12.00	6	\$2.50	\$18.00
4	2.25	16.00	8	3.00	22.00

Square Stakes

Ft.	Doz.	100	Ft.	Doz.	100
1 1/2	\$0.25	\$1.50	6	\$2.00	\$14.00
2	.35	2.50	6	2.25	16.00
2 1/2	.50	3.50	6 Ex. heavy	2.00	14.00
3	.80	6.00	6 Ex. heavy	2.50	18.00
3 1/2	1.10	8.00	6 Ex. heavy	3.00	22.00
4	1.35	10.00			

Stakes, Square, Unpainted. Hardwood 100 1000
 28 inches long \$0.75 \$6.00
 36 inches long 1.00 8.00
 48 inches long 1.25 10.00

Sticks, Match. Pine, 5-32 inch thick. Green. 60c per 100, \$4.00 per 1000.

Styptic, Thompson's (Imported). To prevent the bleeding of grape vines. Small bottle \$1.50, large \$2.00.

Tamper. Dirt and sod, high grade. 8x8 base. \$2.00 each.

Thermometers, Wilder's. Japanned tin case, convex scale. 6 in., 75c; 10 in., \$1.00; 12 in., \$1.25.

Thermometers, Wilder's. Japanned tin case, heavy, 10 in., \$1.40; 12 in., \$1.50; 14 in., \$1.75.

Thermometers, Standard, Hotbed. Boxwood, \$3.50.

Tinfoil. For bouquets, etc. 30c per lb.; green, 60c per lb.

Trellis, Tomato. Two hoops; 25c each, \$2.50 per doz.

Trellis, Tomato, Handy Vine. Made of wood and wire. 35c each, \$4.00 per doz.

Trowels, Garden, English Genuine. 6 in., \$1.00; 7 in., \$1.25.

Trowels, Garden, English Solid Stainless Steel. \$2.00 each.

Trowels, Transplanting. 6 in. 25c; 7 in. 30c each.

Trowels, Pointing. 4 1/2 in. 50c each.

Trowels, Flat, Steel. Best steel, 7 in. \$2.00 each.

Trowel, Garden, Extra forged steel. Solid steel blade and shank. 6 in. 75c; 7 in. 85c, each.

Truck and Leaf Rack, with 3 1/2-in. tires, \$40.00.

Truck and Hand Cart Box, with 3 1/2-in. tires, \$30.00.

Extra Barrels with Trunnions, \$8.50; extra trunnions, 50c.

Leaf Rack only, \$16.00; **Hand Cart Box only,** \$6.00.

Twine, Green Linen. For Smlax, 40c per ball.

Twine, Green Cotton. 20c per ball, \$2.00 per doz.

Twine, Hard. "For tying parcels." Heavy, medium and light. 50c per ball, \$5.50 per doz.

Twine, Soft. 2-, 3-, or 5-ply jute. 25c per ball.

Twine, Tarred Marline. Twisted. In 5-lb. and 10-lb. balls. Each, 85c per lb.

Twine, Tarred Yarn (Lath yarn). Excellent for tying shrubs, etc., 35c per lb.

Twine, White Cotton. 20c per ball, \$2.00 per doz.

Twine, Yacht Marline. In 1/2-lb. balls, \$1.00 each.

Watering Pots. Galvanized iron detachable rose watering pot. 4-qt., 85c; 6-qt., \$1.00; 8-qt., \$1.15; 10-qt., \$1.25; 12-qt., \$1.50.



Watering Pots, English Pattern.

An ideal pot for watering seedlings, cuttings, etc. 3 qt. \$8.00, 4 qt. \$10.00, 6 qt. \$11.00, 8 qt. \$12.00, 10 qt. \$13.50 each.

Watering Pots, Galvanized Iron. The best watering pot made, for strength, durability and neatness. Made from best quality iron; the top and back handles riveted on; an iron band on the bottom; the spout riveted, and a brace around it riveted to the body, and galvanized after it is made. A coarse and fine copper-faced rose with each pot. Extra rose 75c. Each 4 qts., spout 18 in. long. \$6.50 6 qts., spout 21 in. long. 7.00 8 qts., spout 23 in. long. 7.50 10 qts., spout 25 in. long. 8.00 12 qts., spout 25 in. long. 8.50

Watering Pots, French Pattern. Made of galvanized iron; oval in shape, with brass handle and long spout; one fine and one coarse copper-faced rose with each. 6 qt., \$7.40, 8 qt., \$7.90, 10 qt., \$8.40, 12 qt., \$9.40 each.

Wedges, Truckee pattern, solid cast steel. 15c per lb.

Weeder, Magic. Hand, 3-tine, 18 in. handle, 25c each; 30-in. handle, 40c each; 4-tine, heavy 42-in. handle, \$1.00 each.

Weeder, Onion. Triangle-shaped, 8 in. handle, 3 in. blade, 40c each; 4 ft. handle, 3 in. blade, 75c.

Weeder, Three-pronged. 60c each. Long handle, \$1.00.

Weeder, Excelsior. 20c each.

Weeder, Hazeltine. Steel blade, with wooden handle. 35c each, long handle, 50c each.

Wires, Annealed galvanized. No. 14, \$1.50; No. 16, \$1.75; No. 18, \$2.00; No. 20, \$2.25 per stone of 12 lbs., in coils.

Wrenches, Monkey. Knife handle. 6 in., \$1.00 each; 8 in., \$1.25 each; 10 in., \$1.50 each; 12 in., \$2.00 each; 15 in., \$2.50 each.

Wrenches, Stillson. Length when opened, 6 in., 75c each; 8 in., \$1.00 each; 10 in., \$1.25 each; 14 in. \$1.50 each; 18 in., \$2.00 each; 24 in., \$3.00 each.

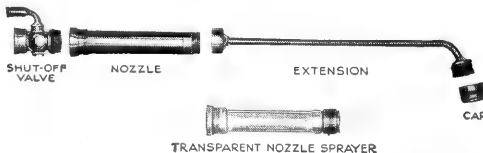

Antipestick - Foodndrink - Sulphur - Pyrethrum

Antipestick Cartridge for control of plant pests, thrips, aphids, green flies, plant lice, etc. 35c each; \$4.00 doz.

Foodndrink Cartridge. A balanced plant food for lawns and plants. 5c each; 25 for \$1.00.

Sulphur Cartridge for control of mildew, rust, black spot, fungous diseases, red spiders and ants. 35c each; \$4.00 per doz.

Pyrethrum-Rotenone Cartridge for control of most chewing and sucking insects. 35c each; \$4.00 per doz.

Brass Container Nozzle. \$1.00. Extension spray elbow (for spraying under the leaves), 75c. Shutoff, \$1.25.

Grey's Approved Sprayers for Insecticides and Fungicides

Streamline Wheelbarrow Sprayer

With or Without High Pressure Tank

For use in spraying orchards, garden truck, etc.; also for spraying whitewash, cold water paints, disinfectants and for general spraying purposes. Exceptionally well built for long, hard service. All working parts are brass. The high pressure air tank, guaranteed for 200 lbs. pressure, will spray for a considerable length of time after the pressure has been pumped up.

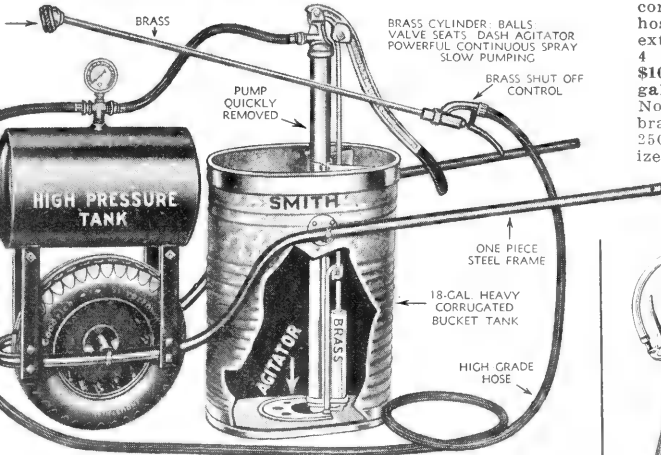

No. 60BPG—Complete, as illustrated. Price, \$41.00.
 No. 60BG—Complete, as illustrated, without High Pressure Tank. Price, \$33.00.
 Equipped with steel wheel, \$5.00 less.

The New E-Z Knapsack Sprayer

UNSURPASSED FOR ALL SPRAYING PURPOSES

Specifications

Tank. 5 gallon capacity, ventilated and form fitting. Copper bearing galvanized steel or solid copper. Large brass filler opening with removable brass strainer.

Air Chamber and Valves. Large capacity for continuous high pressure. All brass valves accurately machined and seated, are easily removed if desired.

Hose Section. 4 feet best grade hose equipped with cast brass automatic shut-off. 2-foot seamless brass extension pipe with adjustable swivel end for all-direction spraying.

Nozzle. Heavy brass, non-clog. 5 different sprays.

No. E-Z-C—Knapsack Sprayer, complete with solid copper tank and agitator. Price, \$32.00.

No. E-Z-G—Knapsack Sprayer, complete with galvanized steel tank and agitator. Price, \$16.50.

New Trigger Control Shutoff on all Pressure Sprayers

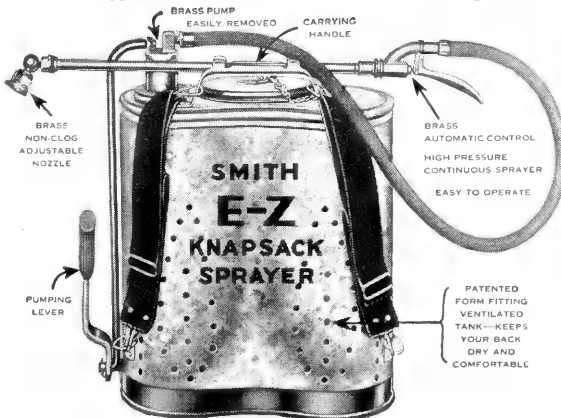

"New - Open - Top Banner Compressed Air Sprayer."

For use in spraying all insecticides on gardens, vegetables, shrubbery, flower beds, etc. Is made with either solid copper tank or with galvanized steel tank. Each sprayer comes complete with hose, nozzle, and brass extension rod. No. 22C0, 4 gallon copper tank, \$10.80; No. 22G0, 4-gallon galvanized tank, \$6.50; No. 25B0, 2½ gallon solid brass tank, \$8.00; No. 25G0, 2½ gallon galvanized tank, \$5.00.



Brown's Open-Hed Compressed Air Sprayer.

Comprising all the latest features in a sprayer of its kind. The first sprayer made with electrically welded seams and galvanized after fabrication. It has a double-acting pump lock with rubber grip pump handle; is quickly, easily locked or unlocked. Both hands can be used for pump. Excellent machine for use with all spraying solutions, for spraying in the garden around the house, dairy barn, poultry house, etc. No. 4B, 4-gallon brass-copper alloy tank, price complete, \$11.75; No. 4D, 4-gallon heavy steel galvanized tank, price complete, \$7.25; No. 3B, 3-gallon brass-copper alloy tank, \$9.45; No. 3D, 3-gallon heavy steel galvanized tank, \$6.35.

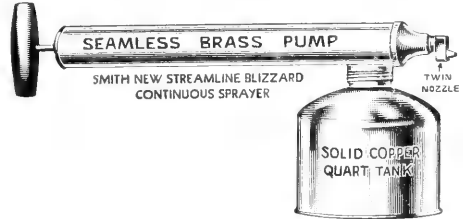

"The New Streamline Blizzard Continuous Hand Sprayer."

For spraying all insecticides on flowers and vegetable plants, etc.; anything in liquid form. Long Brass Extension Nozzle for spraying straight ahead or under side of leaves of low growing plants, 60c; fits qt. size only.

3 sizes: Pt., price \$1.50; Qt., price \$2.25; 2-qt., price \$2.75. Various sizes of small Hand Sprayers from 1 pint to 3 quarts. 50c to \$4.00.

Brown's No. 26 B. G.

A continuous action Sprayer with lithographed tin pump, brass cone, copper jar cap and quart glass jar for the user desiring the many advantages of a visible and non-corrosive container. All brass valve. Price, \$1.25.

Sturdy Spray Pump

Double Action—Continuous Unbroken Spray

Sprays All Insecticides, Disinfectants and Whitewash

Used with pail, bucket, or barrel by simply placing bucket strainer in such vessel. It works with ease on the up-and-down stroke.

Tank—5 gal. galv. steel. Complete with carrying straps. Price, complete, \$10.00. **Pump only,** \$5.00.

Grey's Approved Dusters

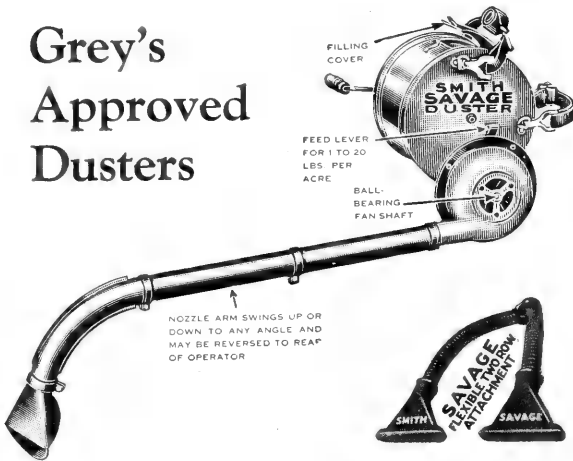

Savage Duster handles all kinds of powder insecticides. A high grade, well built duster to stand long, hard service. Highly adapted for spraying garden, vegetables, shrubbery, plants, etc. It is free running and easy cranking, has no brushes or wipers. Bronze and steel gears packed in grease, sealed-in gear case; never requires any attention; fan shaft runs on ball bearings. Price \$20.00.

Two-Row Attachment. Connects to dust pipe for dusting two rows with one passing. Price \$3.75.

NO. 17 DUST KING POWDER DUSTER
A Powerful, Smooth Operating, Low-Priced One-Man Duster

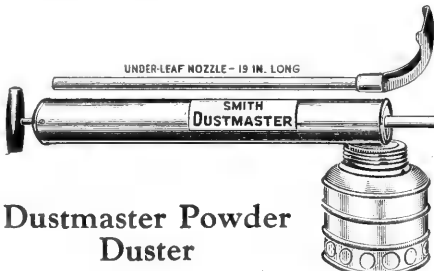
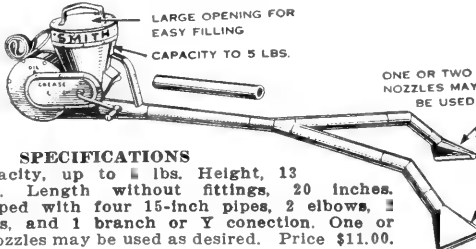

Dustmaster Powder Duster

A splendid high-grade duster—dusts everything in powdered form. Built of the finest materials and made to stand long, hard service. Will stand under side of leaves or at any angle. \$1.25 each.

Handy Duster



A handy duster for use around the house and garden. Handles all insecticides in powder form. It is well built and easily operated. Price 80c.
Construction—Heavy Tin, painted.
Length—Pump 10 in. by 1 1/4 in. Overall length, 17 in.

Hand Garden Tools and Seeders

NO. 301 DOUBLE AND SINGLE WHEEL HOE.

In cultivating onions, beets, turnips, radishes, etc., it is invaluable; saves hours of hard labor. One great advantage which this double wheel hoe possesses is that it can be made into a single wheel hoe in a moment's time. An axle is sent with every double wheel hoe for this purpose. The wheels are 16 inches high. Price \$12.00.

No. 303. The same tool as 301 without vine lifters, cultivator teeth or plows. Side hoes only, \$9.00.

No. 313. The same tool as 301 without plows or vine lifters. Side hoes and four cultivator teeth only. \$10.00.

THE NEW MODEL SEED DRILL

This we consider the simplest and best drill on the market. The diamond-shaped adjustable hole regulates the discharge, and can be made larger or smaller as occasion requires. It has a broad wheel and a covering roller. The opening plow is adjustable in depth. Price \$15.00.

NO. 19C SINGLE WHEEL CULTIVATOR AND PLOW

The distinctive feature of this tool is the high steel wheel measuring 24 inches with land-side plow, scuffle hoe and cultivator teeth, complete. \$6.00.



NO. 306 COMBINED HILL AND DRILL SEEDER DOUBLE AND SINGLE WHEEL HOE

Many should use combination tools for two reasons: They save in first cost and they take up less room.

Thousands of gardeners have found this to be true of No. 306. Complete \$23.00.



OHIO SINGLE WHEEL HOE and CULTIVATOR.
Complete with 1 set of 5 cultivator teeth and 1 pair side hoes. Price \$4.50.

The New Norcross Garden Grower

It Plows—It Weeds—It Cultivates—It Mulches
Positively banishes the back-breaking drudgery and work of garden planting, weeding, cultivating, and mulching, by performing these operations in a quick, easy way, without bending, kneeling, stooping, pulling, tugging or hand hoeing.

Simple to Operate—Well Made

Advantages—Destroys weeds that infest the garden and rob plants of moisture and nutriment—rids gardens of injurious insects attracted by weeds—keeps soil mellow and increases garden yield—works in all kinds of soil. Leaf guards permit all-season use by protecting large or overhanging leaves from wheel movement.

No. 8— 11 in. wide. Price complete.....\$6.50
No. 10—10 in. wide. Price complete.....7.50

The Norcross Hand Garden Cultivator

Does the work easier and faster than any wheel hoe.

5 prong, 4 ft. handle.....\$1.35
3 prong, 4 ft. handle.....1.10
3 prong, 11 in. handle......60

COLDWELL — LAWN MOWERS — MOTOR

FOR SMALL ESTATES—Wheel Type, 19-inch and 21-inch cut.

Amazingly low in initial cost. Fast and economical in performance. Owners of modest lawn areas can enjoy the same beneficent results from a small power mower as the large estate owner. Incorporated in the new Coldwell models are many of the proved mechanical features of the higher priced models. They will produce a beautiful lawn and are recommended also for trimming not only on estates but in parks and cemeteries. Some of the essential features contained in these models:

- Briggs & Stratton Air Cooled, Easy Starting Engine.
- Clutch and Speed Control Throttle on Handle.
- Large Semi-Pneumatic Tires Assure Good Traction.
- Large Sectional Guard Rollers.

We offer the following models: Badger, 19-inch cut, \$82.50; Bear, 21-inch cut, \$107.50; Brownie, 19-inch cut, \$103.50; Brownie, 21-inch cut, \$130.00.

BADGER

SENSATIONAL LIGHTWEIGHT POWER MOWER

Here is the machine that gives you the luxury of power mowing at low cost. It is light in weight, but built powerful and compact with the finest material available.

Uses only $\frac{3}{4}$ gal. of fuel in 1 hour.
Cuts from $\frac{1}{2}$ to $1\frac{1}{4}$ acres per day.
Has a travel speed of 1 to 3 M. P. H.
Cuts grades up to 25%.

It is the peer of all small power mowers.

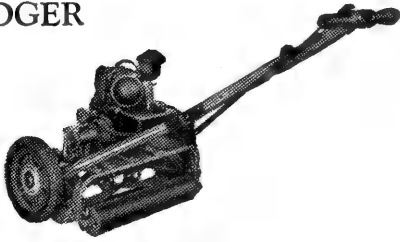

BEAR

The latest of the Coldwell make of power mowers. Large brother to the Badger. Heavier in construction and with larger engine. Is built for larger areas and rougher work. Is sturdy and strong and easy to handle. Can trim close to hedges, shrubs, trees, etc. Considered the peer of all wheel-type power mowers.

MECHANICAL FEATURES

Engine: Briggs & Stratton, 4 cycle air cooled, one horsepower, single cylinder motor with 2" bore and $1\frac{1}{2}$ " stroke. Quick starting magneto; float feed, adjustable carburetor with gasoline filter and oil bath cleaner; automatic governor for speed control; lubrication by pump and splash system; fuel tank capacity $\frac{1}{2}$ gallon; hand starter.

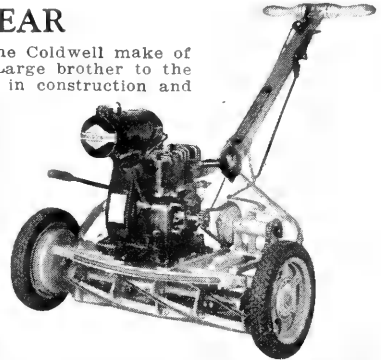

Owing to limited space, we cannot fully describe these machines in our catalog, but will gladly mail a descriptive circular upon request.

HEAVY DUTY MODELS

Roller Type—25 and 30 in. Cut

Coldwell's Heavy Duty Models have an abundance of built-in power. Their versatility and capacity for work are outstanding among the power mowers of today. The Heavy Duty models are especially recommended for extraordinary jobs of mowing, rolling and trimming. There is plenty of power available for steep grades and for thick, tough, or heavy grass. These machines may be used for rolling alone without cutting and they may be transported under their own power without turning the cutting knives. They can also be equipped at additional cost with grass boxes for the collection of cut grass. Also, with pneumatic tired riding sulky to make the task of mowing the lawn more pleasant and shorten the length of time for cutting and also, with gang units, to increase the cutting capacity.

Operating Features

General specifications:

Height of cut, $\frac{3}{4}$ "-2", travel speed, 2-4 M. P. H.; grades up to 35%; cutting capacity, 3-7 acres per day.

Mechanical Features

Motor—Briggs & Stratton, 4.31 H. P. air-cooled, 4 cycle, single cylinder motor with $2\frac{3}{4}$ " bore and $3\frac{3}{4}$ " stroke. Quick starting magneto.

Float feed, adjustable carburetor with air cleaner.

Automatic governor for speed control.

Lubrication by oil pump and splash system.

Fuel tank, $1\frac{1}{4}$ gallon capacity.

Rope starter.

Heavy Duty 25" Regular Model, price \$340.00.

Heavy Duty 30" Regular Model, price \$365.00.

Also, can be supplied in the rubber cover roller model or in the pneumatic tired wheels model at additional cost.

Rear View
Coldwell Brownie
Equipped with
Goodyear All-
Weather Pneu-
matic Tires

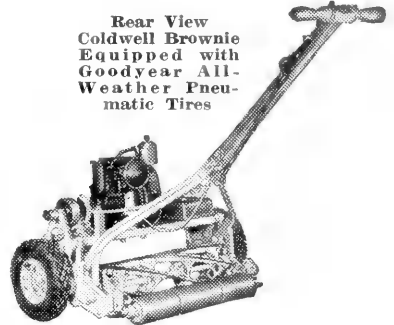

Coldwell's Heavy
Duty Model

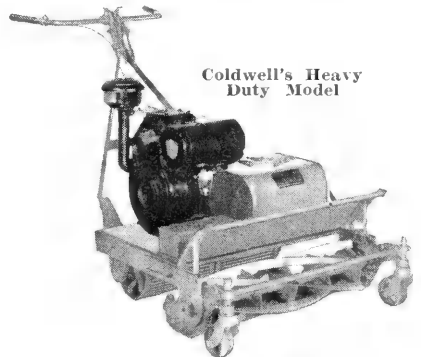

OWING TO UNCERTAIN MARKET CONDITIONS WE ARE UNABLE TO GUARANTEE PRICES. PRICES SUBJECT TO CHANGE WITHOUT NOTICE.

COLDWELL — LAWN MOWERS—HAND

***AMBASSADOR DE LUXE.**—A quality machine of medium weight, equipped with Goodyear pneumatic tires, useful as a general all-purpose machine for well-kept lawns. It is handy on both small grass plots and large areas requiring minimum attention. A popular machine for gardeners and institutional requirements.

Equipped with pneumatic tires, 10" wheels, precision B. B. five steel heat-treated blades, specially treated lipped cutting edge bottom knife.
 16 inch\$20.00 18 inch\$22.00

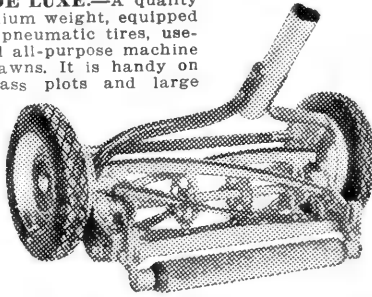

***NEW IMPERIAL SPECIAL.**—Introducing a new leader for the Coldwell line. The old Imperial, which has enjoyed an enviable reputation since lawn mowers were first built, has been completely modernized, equipped with Goodyear rubber tires and new, unusual features, allowing us to offer you a machine that will really last a lifetime.

Equipped with 10" wheels, with semi-pneumatic tires, precision B. B. five-spring steel heat-treated blades, heavy section lipped cutting edge bottom knife.

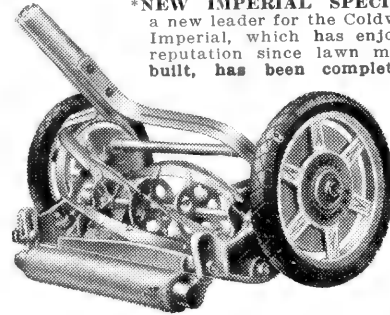

B. B. five-spring steel heat-treated blades, heavy section lipped cutting edge bottom knife.
 16 inch\$20.00 18 inch\$22.00

COLDWELL CRUSADER (BALL BEARING). A light-weight, 5-blade m o w e r, designed to meet the demand for a machine of lighter construction at a moderate price.

14 in., \$8.00 each; 16 in., \$8.50 each; 18 in., \$9.00 each.

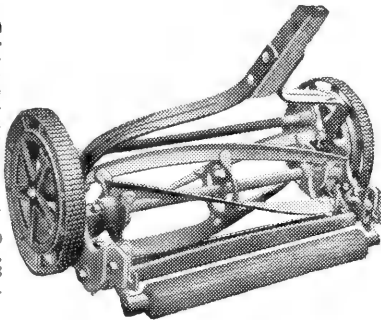

DIPLOMAT SPECIAL. A quality machine of medium weight for fine lawns which are kept unusually trim in appearance. Especially made to endure the service demanded of an all-purpose

mower. Popular machine for the suburbanite and larger estate owner.

Wheels. 10-inch diam., semi-pneumatic tires and rubber-covered guard roller.

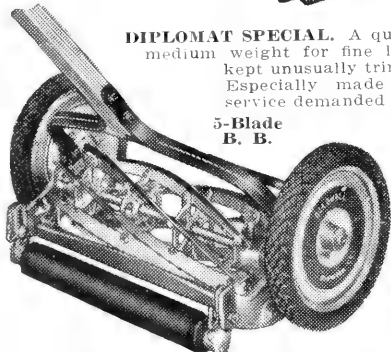

14 in. \$15.00 16 in. \$16.00 18 in. \$17.00

COLDWELL TRIMMER. A special mower with straight side for trimming around the edges of walks, walls, flower beds, and borders where a regular mower cannot be used. Has a 6-inch diameter 5-blade revolving cutter mounted on ball bearings and cuts an 8-inch swath. A small front caster wheel on the left side is supported on an adjustable hanger, which with the guard roller regulates the height of cut.

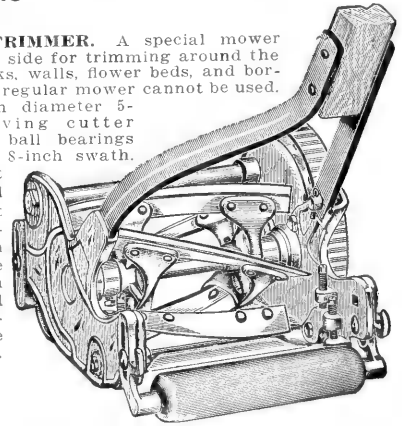

8-inch, \$10.00.

GRASS CATCHERS. Will fit any style of lawn mower. 14 in. and 16 in. \$1.50 each; 18 in. and 20 in. \$2.00 each.

Lawn Mower Service Department

This department, which we have featured for many years, is located in our building, and operated by skilled mechanics.

With its improved facilities for resharpener, repairing, and adjusting hand, horse, and motor mowers, we solicit your patronage. To insure seasonable delivery, early shipments are suggested. Please note what you especially wish done to your mower, on the tag or by letter. In cases where this is omitted, we will sharpen same and put in perfect condition.

AN INDESTRUCTIBLE ALL METAL TOOL MADE OF QUALITY MATERIALS. WEIGHT 13 POUNDS OVERALL LENGTH 4 FT. PLATE 9 INCHES SQUARE. SPIKES 1 3/4 INCHES LONG.

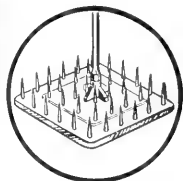

USED AS TAMPER

USED AS SPIKER

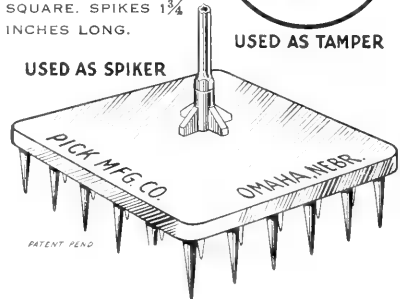

SPIKE-TAMP. The lawn-maker's friend. Can be used as a spiker for perforating the lawn which after being well watered induces a heavy stand of grass, also, reversed and used as a tamper to smooth the sods. Useful from early spring until late fall. Price, \$4.50.

Lawn Sprinklers

Rain King Model G



Brings all the efficiency and quality of "professional" equipment to the home owner at a price within his reach. Provides the slow, revolving shower preferred by greenskeepers and park maintenance men. Sprinkles circles 12 to 100 feet. Less than a quarter turn of the knurled thumb nut gives any known kind of spray from misty shower to soaking downpour. Lockwheel for stationary operation. Spinning eccentric on the patented nozzle prevents stalling, yet permits slow turning. Has new disc-type base. Graceful, streamlined, patented design, brass arm and nozzle. Bronze bearings. Balance rich green enamel. 1 1/2 inches high. Catalog No. G. Price, \$3.95.

A NEW, big job RAIN KING with heavy steel base, 14 inches across. Arm and nozzle solid brass. Phosphor bronze bearings. Cast body. Height, 14 inches. NEW triple-jet nozzles equipped with three sets of inserts for ALL pressures, from 25 pounds to 100 pounds. Changed easy, quick, to suit varying pressures. Puts out 1400 gallons per hour at 60 pounds pressure, 900 gallons at 40 pounds. Perfect distribution over circles up to 140 feet across. Two hose connections — 1-inch and 3/4-inch. Far the biggest value in this field. Price, \$7.95.

Rain King Model J

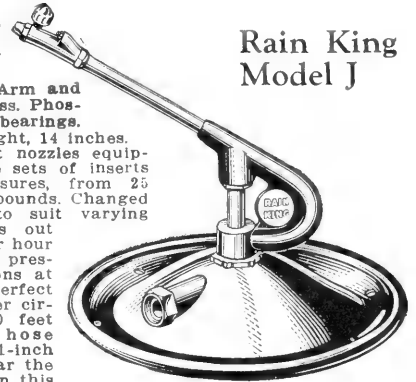

Skinner System Sprinklers

We can supply various styles and sizes. Circular giving full information gladly sent on request.

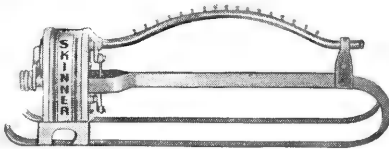

Spray Wave

A compact, small, light, oscillating sprinkler. Waters rectangle up to 40 to 50 feet. Length and speed of spray easily controlled. \$17.50.

Frog Sprinkler

A realistic appearing ornamental lawn sprinkler that throws a spray 4 inches high and 4 1/2 inches wide. Finished in green with black spots and white throat. Ornamental for rock gardens. Price, \$1.00 each.

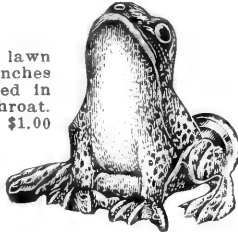

The Famous Model D Standard Sprinkler For 5 Seasons

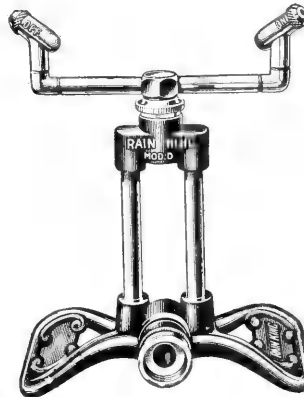

Covers circles up to 50 feet—revolving or stationary

Double nozzles can be set to water circles, long narrow strips, hard-to-reach corners. Each nozzle a sprinkler in itself quickly adjusted for distance, direction and volume. Throws any kind of spray from misty shower to drenching downpour. Bronze bearings throughout. Exclusive, patented nozzles are simple and easy to set. Just a touch changes spray as desired. 11 inches tall, 7 1/2 inches wide at base.

Each\$2.85

Rip Sprinkler

"The Master Rainmaker" (Not Illustrated)

A self adjusting, simple, and economical lawn sprinkler; will not clog or corrode.

Just stick the spike in the ground, turn on the water and see the 150-foot (60 ft. diameter) circle of perfect Raindrops. Will operate efficiently on as low as 5 pounds pressure.

Three Types

No. 1 Spike and No. 2 Irrigation, \$1.00 each. Connection type No. 3, \$1.25 each.

Water Ballast Lawn Roller

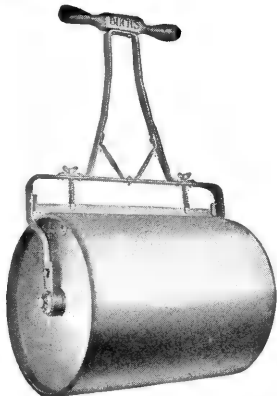

Adapted for rolling lawns, golf courses and tennis courts. Light running, round edge. No tearing up of sod. Scraper to keep surface clean.

Roller bearings in the following sizes:

No.	Diam. Inches	Length Inches	Weight Empty	Filled with Water	Price
602	18	24	85	265	\$17.00
603	24	24	110	420	20.00
604	24	32	130	566	23.00
Plain bearings in the three sizes below.					
605	14	24	68	175	\$12.00
606	18	24	82	265	14.00
607	14	15	50	115	11.00

Roto Spray

A high quality, slow motion revolving balanced sprinkler. Large coverage. Exceedingly durable. 3/4 in. thread, on roller. \$16.00.

A Skinner System Sprinkler

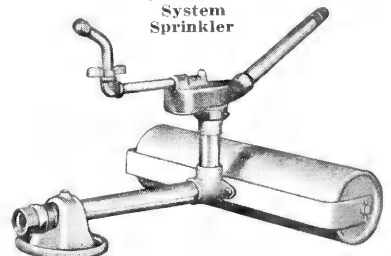

Farm and Garden Tools and Implements

We carry in stock Cultivators, Harrows, Planters, Seeders, Hoes, Mowers, Rakes, and Tedders, some of which are described and illustrated herein. Circulars fully describing our various implements will be mailed upon request.

CULTIVATOR, McCORMICK-DEERING

McCormick-Deering 1-horse cultivators can be supplied in 5-, 7-, and 9-shovel and 14-tooth, with a variety of special equipment that adapts them to the needs of those sections where the work is done with one horse. For the cultivation of all farm and garden crops. Prices on application.

HARROW, McCORMICK-DEERING, SPRING TOOTH, WITH LEVERS

9-tooth, 1 horse, with handles, weight 126 lbs.\$20.00
 15-tooth, 2-horse, two sections, weight 210 lbs. 26.00
 17-tooth, 2- or 3-horse, two sections, weight 228 lbs. 28.00
 Sulky attachment for 15- and 17-tooth Harrows.... 14.00

HARROW, McCORMICK-DEERING DISC

Made with a much stronger frame than the ordinary type disc harrow, being made of a heavy angle steel cross-bar to which draft links are fastened. Made with either solid or cutaway discs. It is made in different sizes for horses or tractors. Can be supplied with fore-carriage and transportation trucks or separate if desired. Prices on application.

HARROW, McCORMICK-DEERING PEG-TOOTH

This harrow can be used with great success on stony ground. Teeth can be quickly set at any desired angle by the lever. One section, with evener, for one horse, \$13.00; two sections with evener, for two horses, \$25.00.

MEEKER SMOOTHING DISC HARROW

Designed especially for market gardeners' work. A perfect harrow and land-roller combined. The frame measures 4 ft. 4 in. by 6 ft., and has four sets of rollers, having 58 steel discs 8 in. diameter on them. The discs grind all the lumps so fine that the seed must come up, leveling and leaving the land fine and smooth and does its work far better than the rake. Price, \$40.00.



THE CHATTANOOGA STEEL HILLSIDE PLOW

They are the result of years of experiment and for strength, lightness and

ease of draft cannot be equaled; while intended for hillside work, will do equally as good work on level land.

No. 208. 1-horse plow with wheel.....\$18.00
 No. 209. 2-horse plow, complete with cutter or jointer 28.00

THE COMBINATION STEEL BEAM LANDSIDE PLOW

The latest and most up-to-date steel landside plows on the market. Furnished with jointers or cutters, as desired.

No. 97. Regular 2-horse, complete\$30.00
 No. 100. Regular 2-horse, same as above, but with shorter beam. Specially adapted for stony ground.
 Complete 30.00

THE ORIGINAL 76 WOOD BEAM HILLSIDE PLOW

This pattern of the popular A. B. C. Series is of light weight and thoroughly constructed. Handles can be raised or lowered. Has automatic cutter, shifting lever clevis and spring foot latch. Two sizes.

B. Regular 2-horse, complete with wheel and cutter. \$26.00
 C. 1-horse, complete with wheel 18.00

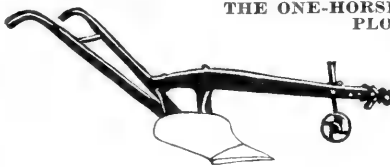

THE ONE-HORSE WOOD BEAM PLOW

Beam adjustable so that the horse can walk on the land or in the furrow.

No. 52. Grey's Special. Regular 1-horse plow with wheel\$18.00

THE VINEYARD AND GARDEN PLOW

Chilled wearing parts. Horse can walk in the furrow or on the land. Handles can be adjusted sideways or up and down. Iron beam, 1-horse with wheel. \$15.00.

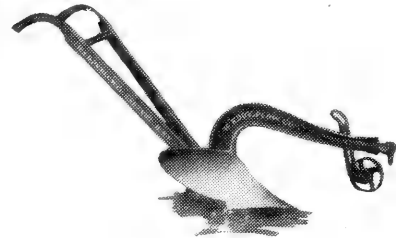

HAND SPREADERS For Plant Food and Grass Seed

Here is a simple contrivance with a positive feed that broadcasts dry fertilizers and grass seeds close to the ground quickly, evenly, and without waste.

35-lb. capacity ...\$ 7.50
 65-lb. capacity ... 13.50
 100-lb. capacity ... 22.00

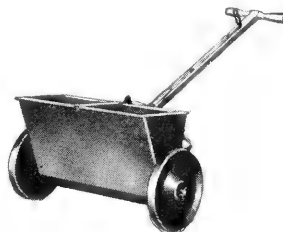

FAIRBANKS STEEL DRAG SCRAPER

Our late addition of a steel drag scraper is of an improved pattern and made without seam or lap, pressed from a single plate of steel. The bowl is well rounded at the sides and curved upward to form the back. They are strong and substantial and made in two sizes. No. 1, 7 cu. ft. \$15.00; No. 2, 5 cu. ft., \$13.50.

7½-FT. HORSE WEEDER

By the use of weeders much time and labor are saved, and better crops grown. They will not cut the roots of the crop, but cultivate just deep enough to retain the moisture where it is most needed. Price, \$18.00.

THE SHOVEL POTATO HOE

It is made to meet the demands of large growers of potatoes, being designed both for hilling and covering purposes. Price, \$18.00.

KING OF THE CORNFIELD CORN PLANTER AND FERTILIZER DISTRIBUTOR COMBINED

For planting field or ensilage corn, beans, peas or beet seeds, in hills or drills with check. Price \$47.50.

NORTHLAND STONE BOATS AND HEADS

Strongly bolted. Heavy woodwork; made in two sizes; 4 ft. by 29 in. and 7 ft. by 32 in. Heads are steel. The wood part is made from rock maple and the whole is thoroughly well bolted, making the very best pattern of stone boat. Prices: 6-ft. boat, complete \$15.00; 7-ft. boat, complete \$20.00; 29 in. head only, with bolts, \$5.00; 32 in. head only, with bolts, \$8.00.



Insecticides and Fungicides

ALL PRICES SUBJECT TO CHANGE WITHOUT NOTICE

- Ant Trap "Tat."** Destroys all species of ants. Trap contains two baits attracting both SWEET and GREASE eating ants. For house or garden. Metal container with non-fluid bait. Each 25c.
- Ant Bait "Tat."** For control of outdoor ants. In jelly form. 1-oz., tubes. 25c each.
- *Arsenate of Lead (Dry).** Lb. 35c, 4 lbs. 90c, 24 lbs. \$4.50.
- *Black Leaf 40** (Sulphate of Nicotine). A concentrated liquid for use in destroying green aphids and thrips. Oz. bottle 35c, 5 ozs. \$1.00, lb. \$2.25, 5 lbs. \$3.25, 5 lbs. \$5.85, 10 lbs. \$10.60.
- *Bordeaux Mixture, Dry.** Can be used either dry as a dust or mixed with water ■■■ spray for all fungous diseases. 1 lb. to 5 gals. of water. 1 lb. 35c, 4 lbs. 95c, 24 lbs. \$4.50.
- Carbola.** A combined disinfectant, insecticide and cold water paint. Unexcelled as a whitewash. 5 lbs. 75c, 10 lbs. \$1.25, 25 lbs. \$2.75, 50 lbs. \$5.00.
- *Creosote, Gypsy Moth.** For the destruction of the eggs of gypsy moth. Qt. 50c, gal. \$1.25, 5 gals. \$5.00.
- Cubor.** A complete rotenone liquid spray. Contains 2 1/2% rotenone. Economical and effective. 4 ozs. 50c, pt. \$1.50, qt. \$2.00, gal. \$6.00.
- *Cyanogas (Calcium Cyanide). "Grade A."** Will destroy rats, ground hogs, etc. 1/2 lb. 45c, lb. 75c, 5 lbs. \$3.00.
- Cyanogas (Grade G).** Fumigant. 5 lbs. \$3.00, 25 lbs. \$10.00.
- Dog-O-Way.** Keeps dogs away from Evergreens. Dust on foliage. Large size 25c.
- Dog Skat.** Tube releases vapor offensive to animals. Large tube 30c.
- Formacide.** Formaldehyde Dust Triple Strength Seed and Soil Disinfectant. For control of damping-off. Full directions on request. 1/2 lb. 45c, 1 lb. 75c, 5 lbs. \$2.00.
- *Fungtrogen.** An effective and scientific preventive and remedy for mildew, black spot and many fungous diseases of Roses and other plants. Pt. \$1.25, qt. \$2.00, 1/2 gal. \$3.50, gal. \$6.00.
- Grape Dust.** For destroying mildew on grape vines and trees affected with mold. 5-lb. pkg. \$1.25.
- *Lemon Oil.** A safe and effective insecticide for all insects and soft scale. Qt. 85c, gal. \$2.50.
- *Lime-Sulphur Solution.** Will completely destroy San Jose and other scale. Qt. 50c, gal. \$1.00, 5 gals. \$3.50, 1/2 barrel, about 30 gals., 50-gal. barrels, price on application.
- *Lime and Sulphur, Dry.** For dormant spraying of fruit; used for same purposes ■■■ Liquid Lime-Sulphur, but is much easier to handle. 1 lb. 35c, 12 1/2-lb. bags \$2.00.
- Nico-Fume Tobacco Paper.** (Registered). For fumigating greenhouses. The strongest Tobacco Paper on the market. 24 sheets \$1.25, 144 sheets \$4.50, 288 sheets \$8.00.
- Nico-Fume Powder.** For fumigating. 5 lbs. \$3.35, 10 lbs. \$5.85.
- Nico-Fume Pressure Fumigator.** The new way. Much more effective than the old loose-piles method. 1/2-lb. can 45c, 1-lb. can 75c. Larger quantities price on application.
- Nu-Green.** For use on golf greens and lawns for control of brown patch. Mix with water, using 1 level tablespoonful to each gallon of water. 3 ozs. 35c, 1 lb. \$1.45, 5 lbs. \$6.25.
- Pomo-Green with Nicotine.** The Leaf Green All-in-one Dust or Spray. A single material used as a dust or spray; does on all leaf-eating or sucking insects, and aphids. Also for diseases on Roses, flowering plants and shrubs without being conspicuous on foliage. 1 lb. 75c, 5 lbs. \$3.00.
- *Richard's X L Liquid Insecticide.** Destroys mealy bug, red spider, etc. Qt. \$3.00, gal. \$10.50.
- Rotenone Dust.** Efficient control of chewing insects. Non-poisonous. Highly recommended for bean beetle, cabbage worm, etc. 1 lb. 30c, 5 lbs. \$1.00, 25 lbs. \$4.25.

- Scalecide.** The most reliable and economical remedy for San Jose scale and all fungous diseases. Qt. 65c, gal. \$1.55, 5 gals. \$5.50, 10 gals. \$9.50.
- Semesan.** Semesan may be applied in dust or liquid form to the seed before planting. It is harmless to seed but deadly to disease organisms which may be on the seed. 1 oz. treats 15 lbs. of seeds. Effective in controlling damping off. ■ ozs. 35c, lb. \$2.25, 5 lbs. \$10.00.
- Slug Shot, Hammond's.** Destroys insects injurious to house and garden plants, vegetables and fruit of all kinds. 1 lb. 25c, 5-lb. pkg. \$1.00.
- Snarol.** For cutworms, snails, etc. Broadcast on the ground under the plants. 1 1/2 lbs. 35c, 5 lbs. 85c, 15 lbs. \$3.00, 50 lbs. \$8.00.
- *Soap Spray, "Imp."** It contains vegetable poisons, harmless to plants, but peculiarly effective against red spider on fruits, etc., the Rhododendron fly. Qt. \$1.00, gal. \$3.00, 5 gals. \$12.00, 10 gals. \$20.00.
- Soap, Fish Oil.** Is a most effective preparation for destroying San Jose scale, plant lice and all sucking insects. 1-lb. box 35c, 5-lb. box \$1.40.
- Sulphur Flour.** Useful for fumigating. Lb. 10c, 5 lbs. 40c, 10 lbs. 75c, 25 lbs. \$1.75, 100 lbs. \$6.50.
- Tobacco Dust.** For aphids, etc., on the foliage and around the roots. Lb. 15c; 5 lbs. 50c, 25 lbs. \$2.00, 50 lbs. \$3.50, 100 lbs. \$6.00.
- Tobacco Stems.** Small quantities. Lb. 5c, \$1.00 per bb. Large bales or cases, lb. 4c.
- Volck.** For the control of red spider and scale. Volck is non-poisonous. Must not be used in connection with lime or sulphur. Qt. 75c, gal. \$2.00.
- Wettable Sulphur.** Recommended as a summer spray on fruits and evergreens. Also effective against blight and mildew. 4 lbs. 50c.
- *Wilson's O. K. Plant Spray.** A contact spray for Roses, Chrysanthemums, Carnations, Grape vines (when dormant). Qt. \$1.00, gal. \$3.00, 5 gals. \$12.00, 10 gals. \$22.00.
- *Weed Exterminator, "Herbicide."** Is a powerful chemical solution for destroying weeds and vegetation of all kinds on roadways, paths, gutters and tennis courts.

1-qt. can	\$0.50	5-gal. can	6.00
1-gal. can	1.50	10-gal. can	10.00

HORMODIN POWDER

"The Root-Forming Chemical"

Its principal use is to stimulate rapid root growth on cuttings. It is simple, economical and scientific. Special circulars on request. Combination Package—Powders No. 1, No. 2, No. 3 in one carton, 75c.



- Red Arrow** is a contact insecticide particularly adapted for flowers, fruits and vegetables. It kills both chewing and sucking insects and is especially recommended for the control of Mexican bean beetle and Gladiolus thrip, ■ well as aphids, leaf hoppers, etc. A very important thing about Red Arrow is that it is economical, combining the highest killing power with the greatest coverage. Oz. 35c, 4 ozs. \$1.00, pt. \$2.85, qt. \$4.50.
- Bye, Bye, Blackbird.** A safe remedy for the user, but sure to rid cornfields of crows, blackbirds, etc. 1/2 pt. 65c, pt. \$1.00.

AGRICULTURAL CHEMICALS and FERTILIZERS

Grey's 9-6-6 Plant Food for Lawns, etc.



Grey's Plant Food contains the necessary ingredients to feed your lawns, flowers, trees and shrubs.

Grey's Plant Food is a "complete" fertilizer, odorless, easy to handle and free of weed seeds.

Grey's Plant Food meets all the plant food requirements to promote a rich, luxuriant growth and an abundance of foliage and bloom.

Grey's Plant Food is adapted to lawns, golf courses and gardens. Also may be used on trees and shrubs with splendid results.

Directions for use in every package.

10 lbs.	\$0.75	50 lbs.	\$2.75
25 lbs.	1.60	100 lbs.	4.50
Ton		\$80.00	

ALL PRICES SUBJECT TO CHANGE WITHOUT NOTICE

- A. A. Superphosphate. 16 per cent soluble and available phosphoric acid. 100 lbs., \$1.75.
- Ashes, Unleached Hardwood. High in potash. In bags, per 100 lbs., \$3.00.
- A. A. Market Garden Fertilizer, 4-8-4. For vegetables and small fruits where a good balance of the three plant foods is desired. A good, high-grade fertilizer to use where moderate applications of manure are occasionally made. 100 lbs. \$2.75.
- Blood Tankage. 14 per cent. \$9.00 per 100 lbs.

Bovung

A Natural Organic Fertilizer

It is the natural plant food for lawns, flowers, etc. It can be applied without fear of burning or harmful results. Price, \$1.50 per bag of 50 lbs.

- Bone, Coarse or Cracked. Ground coarse for Grape borders or poultry. 100 lbs. \$5.00.
- Calcium Chloride. Dust layer and surface binder. 100 lbs. will cover about 50 square yards. 100 lbs. \$4.00.
- Clay's Fertilizers. This valuable imported manure is especially recommended to all who grow either fruit, flowers or vegetables and wish to bring them to the highest perfection. 14 lbs. \$2.50, 28 lbs. \$4.00, 56 lbs. \$7.50, 112 lbs. \$14.00.
- Charcoal. Coarse and fine, 10 lbs. 50c, per 100 lbs. \$4.00.
- Cottonseed Meal. Is being widely used on lawns, golf courses and vegetable gardens. 100 lbs., \$3.50.

ELECTRA "GOLD STAR" FERTILIZER 4-9-3

General all around plant food. Feeding, forcing, finishing. High organic. It makes plants function properly. 25 lbs., \$3.75; 50 lbs. \$6.00; 100 lbs., \$10.50.

- Humus. Finely ground and screened for renovating lawns, golf courses, flower beds, etc. 100 lbs., \$2.00.
- Lime, Agricultural. An unusually pure calcium lime, especially prepared for use on the soil. Shipped in the form of a dry powder in bags of 100 lbs. each. Per 100 lbs. \$1.00; ton, \$18.00.
- Muriate of Potash. 50 per cent actual potash. 100 lbs., \$4.50.
- Nitrate of Soda (Reground). 10 lbs., 75c; 25 lbs., \$1.50; 50 lbs., \$2.50; 100 lbs., \$4.00.
- Pulverized Sheep and Goat Manure. A. A. C. brand. This brand has no objectionable odor. It is pure natural manure and the most nutritious food for plants, lawns, wherever a strong, luxuriant growth is needed.

5 lbs.	\$0.40	50 lbs.	\$2.00
10 lbs.60	100 lbs.	3.25
25 lbs.	1.25	Ton	\$55.00
- Pulverized Poultry Manure. 100 lbs., \$3.50.

- Salt. Top-dressing for lawns and Asparagus beds. Price per bag about 100 lbs. \$2.00.
- Soot, Imported Scotch. Prevents mildew when mixed with sulphur at the rate of one-third sulphur and two-thirds soot; also a good fertilizer. 10 lbs. \$1.00, 100 lbs. \$7.00.
- Sulphate of Ammonia. \$4.00 per 100 lbs.
- Shredded Cattle Manure. 100 lbs. \$3.50.
- Special Ground Bone. An excellent material for use where gradual but long continued effects of nitrogen and phosphoric acid are desired, as under and around perennials, trees and shrubs, or before seeding to grass. 5 lbs., 40c; 10 lbs., 75c; 25 lbs., \$1.25; 50 lbs., \$2.00; 100 lbs., \$3.50.
- Stockbridge Early Crop Manure, 5-8-7. A fertilizer especially adapted to soils lacking nitrogen and for use with all root and other vegetable crops. 100 lbs., \$3.00.
- A. A. Potato and Root Crop Fertilizer, 4-8-10. Well adapted to poor or lightly manured soils—especially for Potatoes, Beets, and for many foliage crops, except Cabbage, which requires considerably more available phosphoric acid. 100 lbs. \$3.00.

Universal Acid Plant Food

6-15-4

A specialty fertilizer for acid loving plants. A complete food for Gardenia, Azalea, Hydrangea, Rhododendrons, etc. 25 lbs. \$3.50, 50 lbs. \$5.50, 100 lbs. \$9.75.

Adco

For making artificial manure. Dry leaves mixed with Adco and kept moist, turn into excellent manure. So do flower stalks, cuttings, pea vines and almost any other kind of non-woody vegetable waste. Adco is a powder which, mixed with vegetable matter and kept moist, turns the latter into real manure, but without odor, flies, etc. In 25-lb. bags (Making 1/2 ton of manure) Each \$2.25 In 150-lb. bags (Making 1 ton of manure) Each \$10.50 In 7 1/2-lb. package (trial size) Each \$1.00

Plantabbs

Plantabbs, with Vitamin B1, makes vastly stronger root growth. Excellent for garden flowers and vegetables, and all potted plants and flowers. In boxes of 30 tablets, 25c; 75 tablets, 50c; 200 tablets, \$1.00; 1000 tablets, \$3.50.



Rootone

"Rootone"—the plant hormone powder for cuttings, seeds and bulbs. Stimulates rooting of cuttings, germination of seeds and bulbs. Stops damping off. Small pkg. 25c; 2-oz. jar \$1.00; 1-lb. can \$5.00.

Naptoside

The New Fumigant-Insecticide Kills Thrips, Millepedes, Sow Bugs, and other insects of the soil. Also used to prevent fungous diseases. Apply one pound to 100 sq. ft. 25 lbs., \$4.00; 50 lbs., \$7.00; 100 lbs., \$13.00.

Tri-O-Gen Rose Garden Spray

Combined spray treatment, fungicide, insecticide, and plant stimulant. Combined as a Kit. Harmless to foliage or blooms. Small Kit, \$1.50; Medium Kit, \$4.00; Large Kit (makes 32 gallons), \$6.00.

Peat, Leaf Mold, etc.

- Peat Moss (Imported). Coarse and fine, \$4.50 per bale.
- Silver Sand. For mixing with potting soil, etc. Pk. 75c, bu. \$2.00.
- Leaf Mold. Best quality. Bag \$3.50.
- Moss, Live Sphagnum. Bu. \$1.50, bag \$3.00.
- Moss, Dry Sphagnum. Bag \$1.50. Small bale \$6.50, large bale \$10.00.
- Orchid Peat, or Fern Root. Best selected. Hand picked. Bu. \$1.75, 2 bu. bag \$3.00.

INDEX

- Abutilon 5, 71
 Acacia 5
 Acanthus 5
 Achillea 5, 72
 Achimenes 5
 Achyranthes 70
 Acidanthera 71
 Aconitum 5, 72
 Acroclinium 5
 Actinidia 80
 Adam's Needle 39
 Adonis 5
 Aethionema 4
 Agathea 5
 Ageratum
 ... 2nd cover, 5, 71
 Agrostemma 6
 Ajuga 72
 Akebia 80
 Alamo Vine 21
 Almond 77
 Alonsoa 6
 Alternanthera 71
 Althea 77
 Alyssum 4, 6, 71, 72
 Amaranthus 6
 Amberboa
 ... 2nd cover
 Ambrosia 6
 Ampelopsis 80
 Amygdalus 77
 Anchusa 6
 Andromeda 83
 Anemone 4, 6, 72
 Antemhis 6, 72
 Antirrhinum
 ... 1, 6, 7, 71
 Apples 84
 Aquilegia
 ... 2nd cover, 4, 7, 72
 Arabis 72
 Aralia 77
 Arbovitae 81
 Arctotis 7
 Arenaria 4
 Argemone 7
 Aristolochia 80
 Armeria 4, 7, 72
 Artemisia 72
 Artichoke 43
 Asclepias 7, 72
 Ash 79
 Asparagus 7, 43
 Asperula 7
 Asphodelus 7
 Asters 1, 8, 9, 71, 72
 Aubrietia 4, 10, 72
 Azalea 77

 Baby's Breath
 ... 4, 20, 73
 Balsam 10
 Balloon Flower 29
 Balloon Vine 10
 Baptisia 10, 72
 Barbary 77, 80
 Barley 68
 Bartonia 10
 Beans 42, 43, 44, 66
 Beautybush 77
 Beech 79
 Beets 42, 45, 66
 Begonia
 ... 2nd cover, 10, 71
 Bellis 11
 Bignonia 80
 Birch 79
 Bird Seeds 65
 Blackberries 85
 Black-Eyed Susan 37
 Blanketflower 19, 73
 Blueberries 85
 Blue Lace Flower 17
 Bocconia 11
 Boltonia 11, 72
 Borecole 50
 Brachycome 11
 Broccoli 44
 Browallia 11
 Brussels Sprouts 45
 Buckwheat 66
 Buddleia 77
 Bugle Plant 72
 Bulbs 70
 Butterfly Flower 34

 Cabbage 42, 46
 Caballia 11
 Catchfly 36
 Cactus 11
 Caladium 71
 Calandrinia 4
 Calceolaria 11
 Calendula 11, 71
 California Poppy 18
 Calliopsis 12
 Callirhoe 12
 Campanula 1, 4, 12, 72
 Caudyuff 12, 21, 74
 Cannas 70, 71
 Canterbury Bells 12
 Cardinal Climber 12
 Cardoon 47
 Carnation 13, 17
 Carrot 42, 47
 Castor-oil Bean
 ... 32, 71
 Catalpa 79
 Cauliflower 42, 47
 Celastrus 80
 Celery 42, 48
 Celosia 13
 Centaurea
 ... 13, 71, 72
 Cerastium 13
 Charlie's 13
 Cheiranthus 13, 73
 Chelone 13
 Cherries 84
 Chervil 47
 Chicory 47
 Chionanthus 77
 Chives 49
 Chrysanthemum
 ... 14, 71, 73
 Clarkia 14
 Clematis 80
 Cleome 14
 Clethra 78
 Cobaea 14, 71, 73
 Coleus 15, 71
 Collards 50
 Collinsia 15
 Columbine
 ... 2nd cover, 4, 7, 72
 Convolvulus 15
 Coralberry 77
 Coreopsis 12, 73
 Corn, Field 66
 Corn, Sweet 42, 48, 49
 Corn Salad 50
 Cornus 77, 79
 Cosmos 15, 71
 Cotoneaster 77
 Crab, Flowering 79
 Cress 50
 Cucumber 42, 49
 Cuphea 15
 Cyclamen 15
 Cydonia 78
 Cynoglossum 15

 Dahlia 15, 70
 Daisy 71
 Daisy, Transvaal 19
 Dandelion 50
 Daphne 77, 83
 Datura 15
 Delphinium 16, 73
 Dianthus
 ... 4, 16, 17, 73
 Diascia 17
 Dicentra 73
 Dictamnus 17, 73
 Didiscus 17
 Dielytra 73
 Digitalis 17, 73
 Dimorphothea 17
 Dogwood 77, 79
 Dolichos 17
 Doronicum 17, 73
 Dracaena 17
 Dusty Miller 13

 Echium 18
 Echinacea 17
 Echinocystis 17
 Echinops 18, 73
 Edelweiss 18
 Eggplant 42, 50
 Elm 79
 Endive 42, 50
 Erigeron 18
 Erinus 4
 Eryngium 18
 Erysimum 18
 Eschscholtzia 18
 Eucynymus 77, 83
 Eupatorium 18, 73
 Euphorbia 18
 Exacum 18

 False Chamomile
 ... 11, 72
 False Indigo 10, 72
 Farm Seeds 65
 Fennel 50
 Ferns 18
 Feticus 50
 Feverfew 25
 Fir 81
 Flame Flower 38, 75
 Flowering Crab 79
 Flowering Rasp-
 berry 78
 Flower Seed Nov-
 elties 2nd cover 1-3
 Foliage and Flow-
 ering Plants 71
 Forget-me-not 25, 74
 Forsythia 77
 Four O'Clock 25
 Foxglove 17, 73
 Fringe Tree 77
 Fuchsia 19, 71
 Funkia 73

 Gaillardia 19, 73
 Garlic 50
 Gentiana 19
 Geranium 19, 71
 Gerbera 19
 Gesnera 19
 Geum 19, 73
 Gilia 19
 Giliflower 34, 35
 Gladiolus 68, 69
 Globe Amaranth 19
 Globeflower 38, 75
 Globe Thistle 18, 73
 Gloxinia 19, 70

 Godetia 19, 20
 Gomphrena 19
 Gourds 20
 Grapes 85
 Grasses, Orna-
 mental 40
 Grass Seeds 63-65
 Grevillea 20
 Gumbo 53
 Gypsophila 4, 20, 73

 Hawthorn 79
 Heather 83
 Hedge Plants 80
 Helenium 20, 73
 Helianthemum 20
 Helianthus 20
 Helichrysum 20
 Heliphila 20
 Helipopsis 73
 Heliotrope 20
 Helleborus 73
 Hemerocallis 74
 Hemlock 80, 81
 Herbs 62
 Hesperis 20
 Heuchera 74
 Hibiscus 21, 74, 77
 Hollyhock 21, 74
 Honesty 21
 Honeysuckle 77, 80
 Hop Vine 21
 Horseradish 50
 Humulus 21
 Hunnemannia 21
 Hyacinth Bean 17
 Hyacinthus 70
 Hydrangea 77

 Iberis 21, 74
 Ice Plant 21, 25
 Impatiens 21
 Incarvillea 21
 Ionopsidium 21
 Ipomoea 21, 22
 Iris 74
 Ivy 80

 Jacobaea 22
 Japanese Quince 73
 Japanese Winter-
 cherry 29
 Jerusalem Cherry 36
 Jetbead 77
 Judas-Tree 79
 Juniper 81

 Kalanchoe 22
 Kale 50
 Kenilworth Ivy 23
 Kochia 22
 Kohlrabi 50
 Kolkwitzia 77
 Kudzu Vine 22

 Lantana 22, 71
 Larkspur 16, 22
 Lathyrus 22
 Lavandula 4, 22, 74
 Lavatera 22
 Lawn Grass 63, 65
 Leek 51
 Leptosyne 23
 Lettuce 42, 51
 Leucothoe 83
 Liatris 23, 74
 Ligustrum 80
 Lilac 78, 80
 Lillies 23, 67

 Liliun 23, 67
 Lily-of-the-Val-
 ley 74
 Linaria 23
 Linden 79
 Linum 4, 23, 74
 Lobelia 23, 71, 74
 Lonicera 77, 80
 Love-in-a-Mist 27
 Lunaria 21
 Lupinus 23
 Lychnis 4, 24, 74
 Lycium 80
 Lythrum 24, 74

 Magnolia 79
 Maidenhair-Tree 79
 Mallow 74
 Malva 24
 Mangel Wurzel
 ... 45, 66
 Maple 79
 Marigold 2, 24, 71
 Martynia 51
 Marvel of Peru 25
 Matricaria 25
 Matthiola 25
 Melons 42
 Mesembryanthe-
 mum 21, 25
 Mignonette 25, 71
 Milfoil 72
 Millet 66
 Mimosa 25
 Mimulus 25
 Mirabilis 25
 Mixtures, Hay 66
 Mixtures, Pasture 65
 Monarda 74
 Montbretias 70
 Moonflower 21, 22
 Morning Glory 21, 22
 Mountain Ash 79
 Mountain Laurel 83
 Mourning Bride 34
 Mulberry 79
 Mushrooms 53
 Muskmelon 52
 Mustard 53
 Mustard Spinach 53
 Myosotis 25, 74

 Nasturtiums 26
 Nemesia 27
 Nemophila 27
 Nepeta 4, 74
 Nicotiana 27, 71
 Nierembergia 27
 Nigella 27

 Oak 79
 Oats 66
 Oenothera 27, 74
 Okra 53
 Onions 42, 64
 Onion Sets 64

 Pachysandra 83
 Pansy 27, 28, 71
 Pansies, Tufted
 ... 38, 39
 Papaver 74
 Parsley 42, 54
 Parsnips 56
 Peaches 84
 Pears 84
 Peas 42, 55, 56
 Peas, Field 66

INDEX—Continued

- Pea-tree, Siberian 78
 Peonies 74, 75
 Pentstemon 28, 74
 Pepper 42, 56
 Pepperbush 78
 Pepper Grass 50
 Petunias 2, 28, 29, 71
 Philadelphus 78
 Phlox 29, 71, 75
 Physalis 29
 Phytostegia 29, 75
 Pine 82
 Pinks 16, 73
 Platycodon 29, 75
 Plumbago 75
 Plums 84
 Polemonium 29
 Polygonum 80
 Poppies 3, 30
 Poplar 79
 Poppy, Tulip 21
 Portulaca 30
 Potatoes 57
 Potentilla 30
 Primrose 31, 32, 75
 Primrose, Evening 27
 Primula 31, 32, 75
 Privet 73, 80
 Pumpkin 57
 Pyrethrum 32, 75
- Quinces 84
- Radish 57
 Ranunculus 32
 Rape 66
 Raspberries 85
 Retinospora 82
 Ricinus 32, 71
 Rhodanthe 32
 Rhododendron 83
 Rhodotypos 77
 Rhubarb 58
 Rock Cress 4, 10, 72
 Rock Garden Seeds 4
 Romeya 33
 Roses 76
 Rutbeckia 33, 75
 Rutabaga 62
 Rye 66
- Saintpaulia 33
 Salpiglossis 33, 71
 Salsify 58
 Salvia 33, 34, 71, 75
 Sanvitalia 34
 Saponaria 34, 75
 Satin Flower 19, 20
 Saxifraga 4
 Scabiosa 3, 34, 75
 Schizanthus 34, 35
 Sedum 36, 75
 Sea Lavender 36, 75
 Sensitive Plant 25
 Shamrock 36
 Shrubs 77, 78
 Shrubs, Evergreen 83
 Siberian Wall-flower 13
 Sidalcea 36
 Silene 4, 36
 Silk-Oak 20
 Small Fruits 85
 Smilax 36
 Smoke Bush 78
 Snapdragon 1, 6, 7
 Snowberry 78
 Snow-on-the-Mountain 18
 Solanum 36
 Sorghum 66
- Sorrel 58
 Spiderflower 14
 Spinach 42, 58
 Spiraea 75, 78, 80
 Spruce 80, 82
 Squash 42, 59
 Statice 36, 75
 Stevia 36
 Stephanandra 78
 Stock 3, 34, 35
 Stock, Night-scented 25
 Stokesia 75
 Strawberries 85
 Sudan Grass 66
 Sunflower 20, 66
 Sweet Peas 36, 37
 Sweet Potatoes 57
 Sweet Rocket 20
 Sweet William 37
 Symphoricarpos 77, 78
 Syringa 78
- Texas Heath 29
 Thalictrum 37
 Thermopsis 37
 Thrift 4, 7, 72
 Thunbergia 37
 Thymus 75
 Tithonia 37
 Tobacco 62
 Tomato 42, 60, 61
 Torenia 37, 71
 Trachelium 37
 Trees, Deciduous 79
 Trees, Evergreen 81, 82
 Trees, Fruit 84
 Tritoma 38, 75
 Trollius 38, 75
 Tropaeolum 38
 Trumpet Flower 15
 Tuberoses 70
 Tulip Poppy 21
 Tunica 4
 Turnip 61, 62
 Turtlehead 13, 72
- Ursinia 38
- Valerian 38
 Vegetable Oyster 58
 Vegetable Seed 43, 62
 Vegetable Seed Collections 41
 Vegetable Roots and Plants 62
 Vegetable Specialties 42
 Venidium 38
 Verbascum 38
 Verbena 38, 71
 Veronica 4, 38, 75
 Vetch 66
 Viburnum 78
 Vinca 38, 71, 75, 83
 Vines 80
 Viola 3, 38, 39, 75
 Virginian Stock 39
 Viscaria 39
- Wallflower 39, 71
 Watermelon 52
 Weigela 78
 Wheat 66
 Wild Garden Flower Seeds 40
 Willow 79
 Wisteria 80
 Wormwood 72
- Xanthisma 39
 Yarrow 72
 Yew 82
 Yucca 39, 83
- Zinnia 3, 39, 40, 71
- ### SUNDRIES
- A. A. Superphosphate 98
 Adco 98
 Adjusto Plant Supports 90
 Antipestick 90
 Ant Trap 97
 Arsenate of Lead 97
 Ashes, Hardwood 98
 Asparagus Buncher 86
 Asparagus Knife 86
- Bamboo Poles 86
 Bands, Rubber 86
 Baskets 86
 Barrows 86
 Barrow Leaf Rack 86
 Bars, Crow 86
 Black Leaf 40 . . . 97
 Blood Tankage 98
 Bone 98
 Bordeaux Mixture 97
 Bovung 98
 Bulb and Seed Pans 87
 Burlap 87
 Burning Brands 87
 Bush Hooks 87
 Bye, Bye, Blackbird 97
- Calcium Chloride 98
 Carbola 97
 Carnation Supports 87
 Cattle Manure 98
 Celery Wrappers 87
 Charcoal 98
 Clay's Fertilizers 98
 Corn Planters 96
 Cottonseed Meal 98
 Cotton Wadding 87
 Creosote 97
 Cubor 97
 Cultivators 92, 96
 Cyanogas 97
- Dibbles 87
 Dog-o-way 97
 Dog Skat 97
 Dusters 92
- Edging Knife 87
 Electric Tape 87
- Farm and Garden Tools and Equipment 96
 Fern Root 98
 Fertilizer Distributor 96
 Floral Tools 87
 Flower Pot Hanger 87
 Flower Pots 87
 Flower Pot Saucers 87
- Flower Vases 87
Formacide 87
 Forks 87
 Functrogen 97
- Garden Books 101
 Garden Gloves 40
 Garden Lines 87
 Garden Reels 87
 Garden Tools 92
 Glass Cutter 87
 Glaziers' Points 87
 Gloves, Gardeners 40, 87
 Grafting Knife 87
 Grafting Wax 87
 Grape Dust 97
 Grass Hooks 87
 Grindstones 87
- Hammers 87
 Handles 87
 Harrow 96
 Hoes 87, 88
 Hormodin 97
 Hose Clamps 88
 Hose Connections 88
 Hose Couplings 88
 Hose Menders 88
 Hose Nozzles 88
 Hose Reducers 88
 Hose Reels 88
 Hose, Rubber 88
 Hose Washers 88
 Humus 98
- Insecticides and Fungicides 90, 97
- Knives, Budding 88
- Labels 88
 Lawn Mowers 93, 94
 Lawn Mower Service Department 94
 Lawn Rakes 89
 Lawn Roller 95
 Leaf Mold 98
 Leaf Rack 86, 90
 Lemon Oil 97
 Lime 98
 Lime Sulphur 98
- Mats, Hotbed 88
 Mattocks 88
 Melon Nets 88
 Mole Traps 88
 Moss, Sphagnum 98
 Muriate of Potash 98
- Naptoside 98
 Nico-Pume Products 97
 Nitragin 65
 Nitrate of Soda 98
 Nu-Green 97
- Oilers 88
- Pails 88
 Paper 88
 Peat Moss 98
 Peat, Orchid 98
 Pencils 88
 Picks 88
 Plant Food 98
 Plant Food Tablets 98
 Plant Sprinklers 89
 Plant Tubs 89
 Plows 92, 96
 Poles 86, 89
- Pomo-Green 97
 Potato Hoe 96
 Potato Hooks 89
 Poultry Manure 98
 Pruners 84, 89
 Pulverized Manure 98
 Putty Bulb 89
- Raffia 89
 Rakes 89
 Red Arrow Spray 97
 Richard's X L All 97
 Rose Spray 98
 Rotenone Dust 97
- Salt 98
 Sand, Silver 98
 Sash, Hotbed 89
 Saws 89
 Scalecide 97
 Scissors 89
 Scoops 89
 Scrapers 96
 Scythes 89
 Scythe Snaths 89
 Scythe Stones 89
 Seeders 92
 Seed Sower 89
 Semesan 49, 97
 Shears 89
 Sheep Manure 98
 Shovels 89
 Sickles 87
 Silkaline 89
 Slug Shot 97
 Snarol 97
 Soap, Fish Oil 87
 Soap Spray 97
 Sod Lifter 89
 Soot 98
 Spades 89
 Spike Tamp 94
- Sprayers and Dusters 90, 91, 92
 Sprinklers 95
 Stake Fasteners 90
 Stakes 90
 Sticks, Match 90
 Stockbridge Manure 98
 Stone Boats 96
 Styptic 90
 Sulphate of Ammonia 98
 Sulphur Flour 97
 Sulphur, Wettable 97
- Tamper 90
 Thermometers 53, 90
 Tinfoil 90
 Tobacco Dust 97
 Tobacco Stems 97
 Trellis 90
 Trowels 90
 Truck 90
 Twine 90
- Vine Guides 87
 Voick 97
- Watering Pots 90
 Weeders 90, 96
 Weed Exterminator 97
 Wedges 90
 Wire 90
 Wrenches 90

THOMAS J. GREY CO., BOSTON

16 SOUTH MARKET ST.

DATE _____ 191

ORDER NO.

Name _____

DATE FILLED

Street _____

Town _____ State _____

Conveyance _____

Gardener's Name _____

Amount Enclosed \$ _____
 (State whether Cash, Draft, P. O. Order, Express Money Order or Stamps.)
 (If goods are wanted by express C. O. D. 25 per cent of the amount must accompany the order.)
 N. B. No plants or perishable goods sent C. O. D.

Filled by _____ Date _____

LEDGER FOLIO

Shipped by _____

Date Shipped _____

We give no warranty, express or implied as to description, quality, productivity, or any other matter of any seeds, bulbs or plants we send out, and will not be in any way responsible for the crop. If the purchaser does not accept the goods on these terms, they are at once to be returned. **THOMAS J. GREY CO.**

NUMBER	QUANTITY	ARTICLE	STOCK NO.	PRICE	DOLLARS	CENTS

Practical Books for the Home Gardener



GARDEN MAINTENANCE. By H. Stuart Orloff and Henry B. Raymore. Illustrated with photographs and drawings. Frontispiece in color. \$2.50.

THE BOOK OF BULBS. By F. F. Rockwell. 187 illustrations, 264 pages. \$2.50.

THE GARDENER. By L. H. Bailey. 116 illustrations, 260 pages. \$2.50.

THE CULTIVATED CONIFERS. By Dr. L. H. Bailey, 404 pages, 162 illustrations. \$7.50.

FRITZ BAHR'S COMMERCIAL FLORICULTURE. Fourth edition. Revised, enlarged—up-to-date. 646 pages. \$5.50.

INFORMAL GARDENS. By H. Stuart Orloff. 104 pages, 17 illustrations. \$1.75.

THE HOME GARDEN HANDBOOKS. By F. F. Rockwell. \$1.25 per volume. The titles now published are: Rock Gardens; Irises; Dahlias; Gladiolus; Roses; Peonies; Evergreens; Shrubs; Lawns.

AROUND THE YEAR IN THE GARDEN. By F. F. Rockwell. 88 illustrations, 350 pages. Revised. \$3.00.

ANNUALS IN THE GARDEN. By H. Stuart Orloff, L. A. Cloth 12 mo. \$1.25.

PERENNIAL GARDENS. By H. Stuart Orloff. 92 pages. 18 illustrations. \$1.25.

GARDEN POOLS—LARGE AND SMALL. By Ransey and Lawrence. 41 illustrations, 122 pages. \$2.50.

THE GARDEN CLUB MANUAL. By Edith R. Fisher. \$2.25.

THE HOME VEGETABLE GARDEN. By E. M. Freeman. 8 illustrations, 214 pages. \$1.75.

GARDEN FLOWERS IN COLOR. A cyclopaedia of flower pictures. 320 pages, 400 photographs in color. \$1.98.



Important to Customers

ORDER EARLY.—We would suggest that customers send us their orders as soon as possible after receiving this catalog, and thus avoid the rush of the planting season. It frequently happens that some articles are not in stock when orders are received. In such cases we forward such as are ready, and the balance as soon as possible.

STOCK SEED.—A large part of our seeds are grown for us on contract by special growers, from our own stock, and in locations best suited for their development. Others are secured from strictly reliable sources, and constant effort is made to secure only the best.

ADDRESS, ETC.—Give name of your Post Office, County and State, sign your name plainly; also specify means of conveyance preferred—whether by parcel post, express or freight.

SHIPPING.—We deliver free to Express, Railroad or Boat. All goods travel at the buyer's risk, our responsibility ceases when we take the carrier's receipt. If goods are damaged so sign for them and enter claim with the carrier at once.

BAGS AND PACKING.—No charge is made for boxes or packing on anything, except Flower Pots, Nursery Stock and Hotbed Sash, and this at cost only. Cloth Bags are charged for at cost and if returned in good condition, charges prepaid, will be credited at price charged.

FREE DELIVERY.—See page 62.

REMITTANCES.—May be made by Express Money Order, P. O. Money Order or Bank Draft; if stamps or cash, send in a Registered Letter Parties having no account with us, who order goods without remittance, must furnish satisfactory references. Boston preferred.

PARCEL POST RATES

Packages must not exceed 100 inches in length and girth combined. Seventy pounds is the limit of weight.

Wght. in lbs.	ZONES							
	Local	1st	3rd	4th	5th	6th	7th	8th
		2nd Up to 150 miles	150 to 300 miles	300 to 600 miles	600 to 1000 miles	1000 to 1400 miles	1400 to 1800 miles	Over 1800 miles
1....	\$0.07	\$0.08	\$0.09	\$0.10	\$0.11	\$0.12	\$0.14	\$0.15
2....	.08	.10	.11	.14	.17	.19	.23	.26
3....	.08	.11	.13	.17	.22	.26	.32	.37
4....	.09	.12	.15	.21	.27	.33	.41	.48
5....	.09	.13	.17	.24	.33	.40	.50	.59
6....	.10	.14	.19	.28	.38	.47	.59	.70
7....	.10	.15	.21	.31	.43	.54	.68	.81
8....	.11	.16	.23	.35	.49	.61	.77	.92
9....	.11	.17	.25	.38	.54	.68	.86	1.03
10....	.12	.18	.27	.42	.59	.75	.95	1.14
11....	.12	.19	.29	.45	.64	.82	1.04	1.25
12....	.13	.21	.31	.49	.70	.89	1.13	1.36

Postage on seeds, bulbs, plants and roots of 8 ounces or less to all zones, is 1c for each 2 ounces.

Postage on general merchandise of 8 ounces or less, to all zones, is 1½c for each 2 ounces.

Due to the unsettled market conditions, we cannot guarantee the prices published in this catalog. Each sale will be subject to current prices and also to any Federal or State Sales Tax in effect. Advances will not be made until necessary.

TERMS ARE NET CASH.—All bills on which short credits are allowed are due on the first of the month succeeding the date of the purchase.

All statements of description and analyses on the label or in advertising matter or otherwise of seeds sold or offered for sale by this vender are based on competent tests of a representative sample of the lot sold and delivered and not otherwise. Except as hereinabove expressly provided, the Thomas J. Grey Company gives no warranty, express or implied, as to description, quality, productiveness or any other matter of any seeds, bulbs or plants it sells, and will not be responsible for the crop. If the purchaser does not accept the goods on these terms, they must at once be returned.

GARDENERS' AND SUPERINTENDENTS' SITUATIONS. We have at all times the names of practical gardeners and superintendents in want of situations on our books. If parties desiring such will write us, we shall be glad to put them in communication with men whom we deem suitable. To aid us in making a selection we ask full particulars. We make no charge for this service.



16 SOUTH MARKET ST.
BOSTON MASS.